

SIMATIC S7-300



4/2	Introduction	
4/4	Central processing units	
4/4	Compact CPUs	
4/21	Standard CPUs	
4/43	Technology CPUs	
4/51	Fail-safe CPUs	
4/64	SIPLUS central processing units	
4/64	SIPLUS Compact CPUs	
4/76	SIPLUS Standard CPUs	
4/87	SIPLUS Fail-safe CPUs	
4/92	Digital modules	
4/92	SM 321 digital input modules	
4/98	SM 322 digital output modules	
4/104	SM 323/SM 327 digital input/output modules	
4/108	SIPLUS digital modules	
4/111	Analog modules	
4/111	SM 331 analog input modules	
4/119	SM 332 analog output modules	
4/122	SM 334 analog input/output modules	
4/125	SM 335 fast analog hybrid module	
4/127	SIPLUS analog modules	
4/130	F digital / analog modules - Safety Integrated	
4/139	SIPLUS F digital / analog modules - Safety Integrated	
4/141	Ex digital input/output modules	
4/147	Function modules	
4/147	FM 350-1 counter module	
4/150	FM 350-2 counter module	
4/152	SIPLUS FM 350-2 counter module	
4/153	FM 351 positioning module	
4/155	FM 352 cam controller	
4/157	FM 352-5 high speed Boolean processor	
4/161	FM 353 positioning module	
4/163	FM 354 positioning module	
4/166	FM 357-2 positioning module	
4/168	Power section FM STEPDRIVE	
4/169	1FL3 stepper motors	
4/171	FM 355 closed-loop control module	
4/174	FM 355-2 temperature control module	
4/177	SM 338 POS input module	
		Function modules (continued)
4/179		IM 174 PROFIBUS module
4/181		SIWAREX U
4/184		SIWAREX FTA
4/187		SIWAREX FTC
4/189		SIWAREX M
4/193		SIWAREX P
4/195		Radio clock module SIPLUS DCF 77
4/196	IQ-Sense modules and sensors	
4/196		IQ-Sense sensor module
4/197		Opto proximity switches SIMATIC PXO with IQ-Sense
4/199		Sonar proximity switches SIMATIC PXS with IQ-Sense
4/200	Special modules	
4/202	Communication	
4/202		CP 340
4/204		SIPLUS CP 340
4/205		CP 341
4/207		SIPLUS CP 341
4/208		CP 343-2
4/209		CP 343-2 P
4/210		CP 342-5
4/212		CP 342-5 FO
4/214		CP 343-5
4/216		CP 343-1 Lean
4/218		CP 343-1
4/221		CP 343-1 Advanced
4/224	Connection methods	
4/224		Front connectors
4/225		Fully modular connection
4/232		Flexible connection
4/234	Interface modules	
4/235	SIPLUS interface modules	
4/236	Power supplies	
4/239	Accessories	

Brochures

For brochures serving as selection guides for SIMATIC products refer to:

<http://www.siemens.com/simatic/printmat>
www.DataSheet4U.com

SIMATIC S7-300

Introduction

S7-300/S7-300F/SIPLUS S7-300

www.DataSheet4U.com

Overview



S7-300

- The modular mini PLC system for the low and mid-performance ranges
- With comprehensive range of modules for optimum adaptation to the automation task
- Flexible use through simple implementation of distributed structures and versatile networking
- User-friendly handling and uncomplicated design without a fan
- Can be expanded without problems when the tasks increase
- Powerful thanks to a range of integrated functions

S7-300F

- Failsafe automation system for plants with increased safety requirements for production technology
- Based on S7-300
- Additional ET 200S and ET 200M distributed I/O stations complete with safety-related modules can be connected; safety-related communication over PROFIBUS DP with the PROFIsafe profile
- Standard modules can be used in addition for non-safety-relevant applications

SIPLUS S7-300

- The PLC for use under harshest environmental conditions
- With extended temperature range from -25 °C to +60 °C
- Suitable for extraordinary medial load (pollution gas atmosphere)
- Occasional short-term condensation and increased mechanical loading permissible
- With the proven PLC technology of the S7-300
- Convenient handling, programming, maintenance and service
- Ideal for use in the automotive industry, environmental technology, mining, chemical plants, production technology, food industry, etc.
- The alternative to expensive custom solutions

For more information please visit our Internet site:

<http://www.siemens.com/siplus>

For brochures serving as selection guides for SIMATIC products refer to:

<http://www.siemens.com/simatic/printmaterial>

www.DataSheet4U.com
Technical specifications
General technical specifications S7-300, S7-300F

Degree of protection	Degree of protection IP20 to IEC 60 529
Ambient temperature	
• With horizontal mounting	0 to 60 °C
• With vertical mounting	0 to 40 °C
Relative humidity	5 to 95%, no condensation (RH severity level 2 in accordance with IEC 61131-2)
Atmospheric	795 to 1080 hPa
Isolation	
• 24 V DC circuits	Test voltage 500 V DC
• 230 V AC circuits	Test voltage 1460 V AC
Electromagnetic compatibility	Requirements of EMC law; Noise immunity according to IEC 61000-6-2, tested according to: IEC 61000-4-2, 61000-4-3, IEC 61000-4-4, IEC 61000-4-5, IEC 61000-4-6 Emitted interference according to EN 50081-2, tested according to EN 55011, class A, group 1
Mechanical rating	
• Vibrations, tested according to/tested with	IEC 60068, Part 2-6/10 up 58 Hz; constant amplitude 0.075 mm; 58 to 150 Hz; constant acceleration 1 g; oscillation period: 10 frequency cycles per axis in each direction of the 3 mutually perpendicular axes
• Shock, tested according to/ tested with	IEC 60068, Part 2-27/half-sine: strength of impact 15 g (peak value), duration 11 ms

General technical specifications SIPLUS S7-300

Climatic environmental conditions	
Temperature	Horizontal mounting: -25 °C to 60 °C Vertical mounting: -25 °C to 40 °C
Relative humidity	5 to 95%; transient condensation permissible, corresponding to relative humidity (RH-), stress grade 2 according to IEC 1131-2 and IEC 721 3-3 class 3K5
Transient icing	-25 °C to 0 °C IEC 721 3-3 class 3K5
Atmospheric pressure	1080 to 795 hPa corresponding to a height of -1000 to 2000 m
Pollutant concentration	SO ₂ : < 0,5 ppm; relative humidity <60%, test: 10 ppm, 4 days H ₂ S: < 0,1 ppm; relative humidity <60%, test: 1 ppm, 4 days (according to IEC 721 3-3; class 3C3)
Mechanical environmental conditions	
Vibrations	Type of vibration: frequency progressions changing at 1 octave per minute. 2 Hz ≤ f ≤ 9 Hz, constant amplitude 3,0 mm, 9 Hz ≤ f ≤ 150 Hz, constant acceleration 1 g, duration of vibration: 10 frequency progressions per axis in each direction of the three mutually perpendicular axes Vibration testing according to IEC 68 section 2-6 (sinus) and IEC 721 3-3, class 3M4
Shock	Type of shock: semisinusoidal, shock strength: 15 g peak value, duration 11 ms, shock direction: 3 shocks each in +/- direction on each of the mutually perpendicular axes Shock testing according to IEC 68 section 2-27
Conformity with standard for electronic devices on rail vehicles (EN 50155, temperature T1, category 1)	Yes ¹⁾

1) Not valid for:
 6AG1314-6CF02-2AB0, 6AG1315-6EG10-2AB0,
 6AG1317-6EJ10-2AB0, 6AG1336-1HE00-2AB0,
 6AG1314-6CF02-2AB0, 6AG1331-7KF02-2AB0,
 6AG1331-7PF02-2AB0, 6AG1332-5HF00-2AB0,
 6AG1334-0KE00-2AB0, 6AG1331-7TB00-4AB0

SIMATIC S7-300

Central processing units

Compact CPUs

Overview CPU 312C



- The compact CPU with integrated digital inputs and outputs
- For small applications with high requirements in terms of processing power
- With process-related functions

Micro memory card required to operate the CPU

Overview 313C-2 PtP



- The compact CPU with integrated digital I/Os and second serial interface
- For installations with high requirements in terms of processing power and response time.
- With process-related functions

Micro memory card required to operate the CPU.

Overview CPU 313C



- The compact CPU with integrated digital and analog inputs and outputs
- For installations with high requirements in terms of processing power and response time.
- With process-related functions

Micro memory card required to operate the CPU.

Overview CPU 313C-2 DP



- The compact CPU with integrated digital I/Os and PROFIBUS DP master/slave interface
- With process-related functions
- For tasks with special functions
- For the connection of standalone I/O devices

Micro memory card required to operate the CPU.

SIMATIC S7-300

Central processing units

Compact CPUs

Overview CPU 314C-2 PtP



- The compact CPU with integrated digital and analog I/Os, as well as a second serial interface
- For installations with high requirements in terms of processing power and response time
- With process-related functions

Micro memory card required to operate the CPU.

Overview CPU 314C-2 DP



- The compact CPU with integrated digital and analog I/Os and PROFIBUS DP master/slave interface
- With process-related functions
- For tasks with special functions
- For the connection of standalone I/O devices

Micro memory card required to operate the CPU.

Technical specifications

	6ES7 312-5BE03-0AB0	6ES7 313-5BF03-0AB0	6ES7 313-6BF03-0AB0	6ES7 313-6CF03-0AB0	6ES7 314-6BG03-0AB0	6ES7 314-6CG03-0AB0
Product status						
Associated programming package	STEP 7 V5.2 + SP 1 or higher + HW update	STEP 7 V5.2 + SP 1 or higher + HW update	STEP 7 V5.2 + SP 1 or higher + HW update	STEP 7 V5.2 + SP 1 or higher + HW update	STEP 7 V 5.2 or higher + SP 1 with HW update	STEP 7 V 5.2 or higher + SP 1 with HW update
Supply voltages						
Rated value						
• DC 24 V	Yes	Yes	Yes	Yes	Yes	Yes
• permissible range, lower limit (DC)	20.4 V	20.4 V	20.4 V	20.4 V	20.4 V	20.4 V
• permissible range, upper limit (DC)	28.8 V	28.8 V	28.8 V	28.8 V	28.8 V	28.8 V
Voltages and currents						
External protection for supply cables (recommendation)	LS-switch Type C min 2 A; LS-switch Type B min. 4 A	LS-switch Type C min 2 A; LS-switch Type B min. 4 A	LS-switch Type C min 2 A; LS-switch Type B min. 4 A	LS-switch Type C min 2 A; LS-switch Type B min. 4 A	LS-switch Type C min 2 A; LS-switch Type B min. 4 A	LS-switch Type C min 2 A; LS-switch Type B min. 4 A
Current consumption						
Inrush current, typ.	3 A	11 A	11 A	11 A	11 A	11 A
I _t	0.7 A ² s	0.7 A ² s	0.7 A ² s	0.7 A ² s	0.7 A ² s	0.7 A ² s
Current consumption (in no-load operation), typ.	60 mA	150 mA	100 mA	100 mA	150 mA	150 mA
Current consumption (rated value)	500 mA	700 mA	700 mA	900 mA	800 mA	1.000 mA
from supply voltage L+, max.	500 mA	700 mA	700 mA	900 mA	800 mA	1.000 mA
Power loss, typ.	6 W	14 W	10 W	10 W	14 W	14 W
Memory						
Memory						
• RAM						
- integrated	32 KByte; for program and data, less the display data	64 KByte; for program and data, less the display data	64 KByte; for program and data, less the display data	64 KByte; for program and data, less the display data	96 KByte; for program and data, less the display data	96 KByte; for program and data, less the display data
- expandable	No	No	No	No	No	No

www.DataSheet4U.com

SIMATIC S7-300

Central processing units

Compact CPUs

Technical specifications (continued)

	6ES7 312-5BE03-0AB0	6ES7 313-5BF03-0AB0	6ES7 313-6BF03-0AB0	6ES7 313-6CF03-0AB0	6ES7 314-6BG03-0AB0	6ES7 314-6CG03-0AB0
• Load memory						
- pluggable (MMC)	Yes	Yes	Yes	Yes	Yes	Yes
- pluggable (MMC), max.	4 MByte	8 MByte	8 MByte	8 MByte	8 MByte	8 MByte
Backup						
• present	Yes; Guaranteed by MMC (maintenance-free)	Yes; Guaranteed by MMC (maintenance-free)	Yes; Guaranteed by MMC (maintenance-free)	Yes; Guaranteed by MMC (maintenance-free)	Yes; Guaranteed by MMC (maintenance-free)	Yes; Guaranteed by MMC (maintenance-free)
• without batterie	Yes; Program and data	Yes; Program and data	Yes; Program and data	Yes; Program and data	Yes; Program and data	Yes; Program and data
CPU/blocks						
DB						
• Number, max.	511; Number band: 1 to 511	511; Number band: 1 to 511	511; Number band: 1 to 511	511; Number band: 1 to 511	511; Number band: 1 to 511	511; Number band: 1 to 511
• Size, max.	16 KByte	16 KByte	16 KByte	16 KByte	16 KByte	16 KByte
FB						
• Number, max.	1,024; Number band: 0 to 2047	1,024; Number band: 0 to 2047	1,024; Number band: 0 to 2047	1,024; Number band: 0 to 2047	1,024; Number band: 0 to 2047	1,024; Number band: 0 to 2047
• Size, max.	16 KByte	16 KByte	16 KByte	16 KByte	16 KByte	16 KByte
FC						
• Number, max.	1,024; Number band: 0 to 2047	1,024; Number band: 0 to 2047	1,024; Number band: 0 to 2047	1,024; Number band: 0 to 2047	1,024; Number band: 0 to 2047	1,024; Number band: 0 to 2047
• Size, max.	16 KByte	16 KByte	16 KByte	16 KByte	16 KByte	16 KByte
OB						
• Number, max.	See Operation List	See Operation List	See Operation List	See Operation List	See Operation List	See Operation List
• Size, max.	16 KByte	16 KByte	16 KByte	16 KByte	16 KByte	16 KByte
Nesting depth						
• per priority class	8	8	8	8	8	8
• additional within an error OB	4	4	4	4	4	4
CPU/processing times						
for bit operations, min.	0.2 µs	0.1 µs	0.1 µs	0.1 µs	0.1 µs	0.1 µs
for word operations, min.	0.4 µs	0.2 µs	0.2 µs	0.2 µs	0.2 µs	0.2 µs
for fixed point arithmetic, min.	5 µs	2 µs	2 µs	2 µs	2 µs	2 µs
for floating point arithmetic, min.	6 µs	3 µs	3 µs	3 µs	3 µs	3 µs
Times/counters and their remanence						
S7 counter						
• Number	128	256	256	256	256	256
• of which remanent without battery						
- adjustable	Yes	Yes	Yes	Yes	Yes	Yes
- lower limit	0	0	0	0	0	0
- upper limit	127	255	255	255	255	255
Remanence						
- adjustable	Yes	Yes	Yes	Yes	Yes	Yes
- lower limit	0	0	0	0	0	0
- upper limit	127	255	255	255	255	255
• Counting Range						
- lower limit	0	0	0	0	0	0
- upper limit	999	999	999	999	999	999

SIMATIC S7-300

Central processing units

Compact CPUs
4
Technical specifications (continued)

	6ES7 312-5BE03-0AB0	6ES7 313-5BF03-0AB0	6ES7 313-6BF03-0AB0	6ES7 313-6CF03-0AB0	6ES7 314-6BG03-0AB0	6ES7 314-6CG03-0AB0
IEC-Counter						
• present	Yes	Yes	Yes	Yes	Yes	Yes
• Type	SFB	SFB	SFB	SFB	SFB	SFB
S7 times						
• Number	128	256	256	256	256	256
• Remanence						
- adjustable	Yes	Yes	Yes	Yes	Yes	Yes
- lower limit	0	0	0	0	0	0
- upper limit	127	255	255	255	255	255
- preset	no retentivity	no retentivity	no retentivity	no retentivity	no retentivity	no retentivity
• Time range						
- lower limit	10 ms	10 ms	10 ms	10 ms	10 ms	10 ms
- upper limit	9,990 s	9,990 s	9,990 s	9,990 s	9,990 s	9,990 s
IEC timer						
• present	Yes	Yes	Yes	Yes	Yes	Yes
• Type	SFB	SFB	SFB	SFB	SFB	SFB
Data areas and their remanence						
Flag						
• Number, max.	128 Byte	256 Byte	256 Byte	256 Byte	256 Byte	256 Byte
• Remanence available	Yes; MB 0 to MB 127	Yes; MB 0 to MB 255	Yes; MB 0 to MB 255	Yes; MB 0 to MB 255	Yes; MB 0 to MB 255	Yes; MB 0 to MB 255
• Number of clock memories	8; 1 memory byte	8; 1 memory byte	8; 1 memory byte	8; 1 memory byte	8; 1 memory byte	8; 1 memory byte
Data blocks						
• Number, max.	511; from DB1 to DB511	511; from DB1 to DB511	511; from DB1 to DB511	511	511	511
• Size, max.	16 KByte	16 KByte	16 KByte	16 KByte	16 KByte	16 KByte
• Remanence adjustable	Yes; via non-retain property on DB	Yes; via non-retain property on DB	Yes; via non-retain property on DB	Yes; via non-retain property on DB	Yes; via non-retain property on DB	Yes; via non-retain property on DB
• Remanence preset	Yes	Yes	Yes	Yes	Yes	Yes
Local data						
• per priority class, max.	256 Byte	510 Byte	510 Byte	510 Byte	510 Byte	510 Byte
Address area						
I/O address area						
• Inputs	1 KByte	1 KByte	1 KByte	1 KByte	1 KByte	1 KByte
• Outputs	1 KByte	1 KByte	1 KByte	1 KByte	1 KByte	1 KByte
• of which, distributed						
- Inputs			none	1,008 KByte; max.	none	1,000 Byte
- Outputs			none	1,008 KByte; max.	none	1,008 Byte
Process image						
• Inputs	128 Byte	128 Byte	128 Byte	128 Byte	128 Byte	128 Byte
• Outputs	128 Byte	128 Byte	128 Byte	128 Byte	128 Byte	128 Byte
Digital channels						
• Inputs	266	1,016	1,008	8,192	1,016	8,192
• Outputs	262	1,008	1,008	8,192	1,008	8,192
• Inputs, of which central	266	1,016	1,008	1,008	1,016	1,016
• Outputs, of which central	262	1,008	1,008	1,008	1,008	1,008

SIMATIC S7-300

Central processing units

Compact CPUs

Technical specifications (continued)

	6ES7 312-5BE03-0AB0	6ES7 313-5BF03-0AB0	6ES7 313-6BF03-0AB0	6ES7 313-6CF03-0AB0	6ES7 314-6BG03-0AB0	6ES7 314-6CG03-0AB0
Analog channels						
• Inputs	64	253	248	512	253	512
• Outputs	64	250	248	512	250	512
• Inputs, of which central	64	253	248	248	253	253
• Outputs, of which central	64	250	248	248	250	250
Hardware config.						
Central devices, max.	1	1	1	1	1	1
Expansion devices, max.	0	3	3	3	3	3
Racks, max.	1	4	4	4	4	4
Modules per rack, max.	8	8; in rack 3 max. 7	8; in rack 3 max. 7	8; in rack 3 max. 7	8; in rack 3 max. 7	8; in rack 3 max. 7
Number of DP masters						
• integrated	none	none	none	1	none	1
• via CP	4	4	4	4	4	4
Number of operable FMs and CPs (recommended)						
• FM	8	8	8	8	8	8
• CP, point-to-point	8	8	8	8	8	8
• CP, LAN	4	6	6	6	10	10
Time						
Clock						
• Hardware clock (real-time clock)		Yes	Yes	Yes	Yes	Yes
• Software clock	Yes					
• Battery backed and synchronized	No	Yes	Yes	Yes	Yes	Yes
• Deviation per day, max.	15 s	10 s	10 s	10 s	10 s	10 s
Operating hours counter						
• Number	1	1	1	1	1	1
• Number/Number range	0	0	0	0	0	0
• Range of values	2 [^] 31 hours (when using the SFC 101)	2 [^] 31 hours (when using the SFC 101)	2 [^] 31 hours (when using the SFC 101)	2 [^] 31 hours (when using the SFC 101)	2 [^] 31 hours (when using the SFC 101)	2 [^] 31 hours (when using the SFC 101)
• Granularity	1 hour	1 hour	1 hour	1 hour	1 hour	1 hour
• remanent	Yes; must be restarted at each warm restart	Yes; must be restarted at each warm restart	Yes; must be restarted at each warm restart	Yes	Yes; must be restarted at each warm restart	Yes; must be restarted at each warm restart
Clock synchronization						
• supports	Yes	Yes	Yes	Yes	Yes	Yes
• to MPI, Master	Yes	Yes	Yes	Yes	Yes	Yes
• to MPI, Slave	Yes	Yes	Yes	Yes	Yes	Yes
• in AS, Master	Yes	Yes	Yes	Yes	Yes	Yes
S7 message functions						
Number of login stations for message functions, max.	6; depending on the configured connections for PG-/ OP- and S7- basic communication	8; depending on the configured connections for PG-/ OP- and S7- basic communication	8; depending on the configured connections for PG-/ OP- and S7- basic communication	8	12; depending on the configured connections for PG-/ OP- and S7- basic communication	12; depending on the configured connections for PG-/ OP- and S7- basic communication
Process diagnostic messages	Yes	Yes	Yes	Yes	Yes	Yes
Simultaneously active Alarm-S blocks, max.	20	20	20	20	40	40

www.DataSheet4U.com
Technical specifications (continued)

	6ES7 312-5BE03-0AB0	6ES7 313-5BF03-0AB0	6ES7 313-6BF03-0AB0	6ES7 313-6CF03-0AB0	6ES7 314-6BG03-0AB0	6ES7 314-6CG03-0AB0
Test commissioning functions						
Status/control						
• Status/control variable	Yes	Yes	Yes	Yes	Yes	Yes
• Variables	Inputs, outputs, memory bits, DB, times, counters	Inputs, outputs, memory bits, DB, times, counters	Inputs, outputs, memory bits, DB, times, counters	Inputs, outputs, memory bits, DB, times, counters	Inputs, outputs, memory bits, DB, times, counters	Inputs, outputs, memory bits, DB, times, counters
Monitoring functions						
• Number of variables, max.	30	30	30	30	30	30
• of which status variable, max.	30	30	30	30	30	30
• of which control variable, max.	14	14	14	14	14	14
Forcing						
• Forcing	Yes	Yes	Yes	Yes	Yes	Yes
• Force, variables	Inputs, outputs	Inputs, outputs	Inputs, outputs	Inputs, outputs	Inputs, outputs	Inputs, outputs
• Forcing, number of variables, max.	10	10	10	10	10	10
Status block	Yes	Yes	Yes	Yes	Yes	Yes
Single step	Yes	Yes	Yes	Yes	Yes	Yes
Number of breakpoints	2	2	2	2	2	2
Diagnostic buffer						
• present	Yes	Yes	Yes	Yes	Yes	Yes
• Number of breakpoints	100	100	100	100	100	100
• adjustable				No		
Communication functions						
PG/OP communication	Yes	Yes	Yes	Yes	Yes	Yes
Routing	No	No	No	Yes	No	Yes
Global data communication						
• supported	Yes	Yes	Yes	Yes	Yes	Yes
• Size of GD packets, max.	22 Byte	22 Byte	22 Byte	22 Byte	22 Byte	22 Byte
S7 basic communication						
• supported	Yes	Yes	Yes; Server	Yes	Yes	Yes
S7 communication						
• supported	Yes	Yes	Yes	Yes	Yes	Yes
S5-compatible communication						
• supported	Yes; via CP and loadable FC	Yes; via CP and loadable FC	Yes; via CP and loadable FC	Yes; via CP and loadable FC	Yes; via CP and loadable FC	Yes; via CP and loadable FC
Number of connections						
• overall	6	8	8	8	12	12
• usable for PG communication	5	7	7	7	11	11
• usable for OP communication	5	7	7	7	11	11
• usable for S7 basic communication	2	4	4	4	8	8
• usable for routing	No	No	No	4; max.	No	4; max.
Connection point						
required front connectors	1 x 40-pin	2 x 40-pin	1 x 40-pin	1 x 40-pin	2 x 40-pin	2 x 40-pin
MPI						
Cable length, max.	50 m; without repeater	50 m; without repeater	50 m; without repeater	50 m; without repeater	50 m; without repeater	50 m; without repeater
Point-to-point						
Cable length, max.			1,200 m		1,200 m	

SIMATIC S7-300

Central processing units

Compact CPUs

Technical specifications (continued)

	6ES7 312-5BE03-0AB0	6ES7 313-5BF03-0AB0	6ES7 313-6BF03-0AB0	6ES7 313-6CF03-0AB0	6ES7 314-6BG03-0AB0	6ES7 314-6CG03-0AB0
Integrated protocol driver						
<ul style="list-style-type: none"> • 3964 (R) • ASCII • RK512 			Yes		Yes	
Transmission speed, RS 422/485						
<ul style="list-style-type: none"> • with 3964 (R) protocol, max. • with ASCII protocol, max. • with RK 512 protocol, max. 			38.4 kbit/s half duplex; 19.2 kbit/s full duplex		19.2 kBit/s; 38.4 kbit/s half duplex; 19.2 kbit/s full duplex	
			38.4 kbit/s half duplex; 19.2 kbit/s full duplex		19.2 kBit/s; 38.4 kbit/s half duplex; 19.2 kbit/s full duplex	
					19.2 kBit/s; 38.4 kbit/s half duplex; 19.2 kbit/s full duplex	
					19.2 kBit/s; 38.4 kbit/s half duplex; 19.2 kbit/s full duplex	
1st interface						
Type of interface	integrated RS 422/485 interface	integrated RS 422/485 interface	integrated RS 422/485 interface	integrated RS 422/485 interface	integrated RS 485 interface	integrated RS 422/485 interface
Physics	RS 485	RS 485	RS 485	RS 485	RS 485	RS 485
isolated	No	No	No	Yes	No	No
Power supply to interface (15 to 30 V DC), max.	200 mA	200 mA	200 mA	200 mA	200 mA	200 mA
Functionality						
<ul style="list-style-type: none"> • MPI • DP master • DP slave • Point-to-point coupling 	Yes No No No	Yes No No No	Yes No No No	Yes No No No	Yes No No No	Yes No No No
MPI						
<ul style="list-style-type: none"> • Number of connections • Services <ul style="list-style-type: none"> - PG/OP communication - Routing - Global data communication - S7 basic communication - S7 communication - S7 communication, as client - S7 communication, as server • Transmission speeds, max. 	6 Yes No Yes Yes Yes No Yes	8 Yes No Yes Yes Yes No Yes	8 Yes No Yes Yes Yes No Yes	8 Yes Yes Yes Yes No Yes	12 Yes No Yes Yes Yes No Yes	12 Yes Yes Yes Yes No Yes
	187.5 kBit/s	187.5 kBit/s	187.5 kBit/s	187.5 kBit/s	187.5 kBit/s	187.5 kBit/s
2nd interface						
Type of interface			integrated RS 422/485 interface	integrated RS 422/485 interface	integrated RS 422/485 interface	integrated RS 422/485 interface
Physics			RS 422/ RS 485 (X.27)	RS 485	RS 422/ RS 485 (X.27)	RS 485
isolated			Yes	Yes	Yes	Yes
Power supply to interface (15 to 30 V DC), max.			No	200 mA	No	200 mA

SIMATIC S7-300

Central processing units

Compact CPUs
4
Technical specifications (continued)

	6ES7 312-5BE03-0AB0	6ES7 313-5BF03-0AB0	6ES7 313-6BF03-0AB0	6ES7 313-6CF03-0AB0	6ES7 314-6BG03-0AB0	6ES7 314-6CG03-0AB0	
Functionality							
<ul style="list-style-type: none"> • MPI • DP master • DP slave • Point-to-point coupling • PROFINET CBA • PROFINET IO controller 			No	No	No	No	
DP master							
<ul style="list-style-type: none"> • Number of connections, max. • Number of connections (of which reserved), max. • Services <ul style="list-style-type: none"> - PG/OP communication - Routing - Global data communication - S7 basic communication - S7 communication - S7 communication, as client - S7 communication, as server - equidistance support - SYNC/FREEZE - Activation/deactivation of DP slaves - direct data exchange (cross traffic) - DPV1 				8; for PG/OP communication 1 for PG, 1 for OP		12; for PG/OP communication 1 for PG, 1 for OP	
<ul style="list-style-type: none"> • Transmission speeds, max. • Number of DP slaves, max. • Address area <ul style="list-style-type: none"> - Inputs, max. - Outputs, max. 				12 Mbit/s 32		12 Mbit/s 32	
<ul style="list-style-type: none"> • Useful data per DP slave <ul style="list-style-type: none"> - Inputs, max. - Outputs, max. 				1 KByte 1 KByte		1 KByte 1 KByte	
DP slave							
<ul style="list-style-type: none"> • Number of connections • Services <ul style="list-style-type: none"> - PG/OP communication - Routing - Global data communication - S7 basic communication - S7 communication, as client - S7 communication, as server - direct data exchange (cross traffic) - DPV1 				8		12	
					Yes Yes; only when interface active No Yes No Yes Yes No		Yes Yes; only when interface active No Yes No Yes Yes No

SIMATIC S7-300

Central processing units

Compact CPUs

Technical specifications (continued)

	6ES7 312-5BE03-0AB0	6ES7 313-5BF03-0AB0	6ES7 313-6BF03-0AB0	6ES7 313-6CF03-0AB0	6ES7 314-6BG03-0AB0	6ES7 314-6CG03-0AB0
<ul style="list-style-type: none"> GSD file 				You can obtain the current GSD file from http://www.ad.siemens.de/support in the Product Support area		You can obtain the current GSD file from http://www.ad.siemens.de/support in the Product Support area
<ul style="list-style-type: none"> Transmission speeds, max. automatic baud rate search 				12 kBit/s Yes; only with passive interface		12 kBit/s Yes; only with passive interface
<ul style="list-style-type: none"> Transfer memory <ul style="list-style-type: none"> Inputs Outputs 				244 Byte 244 Byte		244 Byte 244 Byte
<ul style="list-style-type: none"> Address area, max. Useful data per address area, max. 				32 32 Byte		32 32 Byte
Point-to-point coupling						
<ul style="list-style-type: none"> Transmission speed, max. 			38.4 kbit/s half duplex; 19.2 kbit/s full duplex		38.4 kBit/s; 38.4 kbit/s half duplex; 19.2 kbit/s full duplex	
<ul style="list-style-type: none"> Cable length, max. interface from the user program controllable interface can trigger alarm/interrupt in the user program Protocol driver 			1,200 m Yes Yes; Message on break identification 3964 (R); ASCII		1,200 m Yes Yes; Message on break identification 3964 (R); ASCII and RK 512	
CPU/programming						
Programming language						
<ul style="list-style-type: none"> STEP 7 	Yes; V5.2 + SP1 + HW update	Yes; V5.2 + SP1 + HW update	Yes; V5.2 + SP1 + HW update	Yes; V5.1 SP2 + HW update	Yes; V5.2 SP1 with HW update	Yes; V5.2 SP1 with HW update
<ul style="list-style-type: none"> KOP FUP AWL SCL CFC GRAPH HiGraph 	Yes Yes Yes Yes Yes Yes Yes	Yes Yes Yes Yes Yes Yes Yes	Yes Yes Yes Yes Yes Yes Yes	Yes Yes Yes Yes Yes Yes Yes	Yes Yes Yes Yes Yes Yes Yes	Yes Yes Yes Yes Yes Yes Yes
Software libraries						
Operational stocks	see Instruction List	see Instruction List	see Instruction List	see Instruction List	see Instruction List	see Instruction List
Nesting Levels	8	8	8	8	8	8
User program protection/password protection	Yes	Yes	Yes	Yes	Yes	Yes
System functions (SFC)	see Instruction List	see Instruction List	see Instruction List	see Instruction List	see Instruction List	see Instruction List
System function blocks (SFB)	see Instruction List	see Instruction List	see Instruction List	see Instruction List	see Instruction List	see Instruction List

SIMATIC S7-300

Central processing units

Compact CPUs

4

Technical specifications (continued)

	6ES7 312-5BE03-0AB0	6ES7 313-5BF03-0AB0	6ES7 313-6BF03-0AB0	6ES7 313-6CF03-0AB0	6ES7 314-6BG03-0AB0	6ES7 314-6CG03-0AB0
Digital inputs						
Number of digital inputs	10	24	16	16	24	24
• of which, inputs usable for technological functions	8	12	12	12	16	16
Number of simultaneously controllable inputs						
• vertical installation - up to 40 °C, max.	5	12	8	8	12	12
• horizontal installation - up to 40 °C, max. - up to 60 °C, max.	10 5	24 12	16 8	16 8	24 12	24 12
Cable length						
• Cable length, shielded, max.	1,000 m; 100 m for technological functions	1,000 m; 100 m for technological functions	1,000 m; 100 m for technological functions	1,000 m; 100 m for technological functions	1,000 m; 100 m for technological functions	1,000 m; 100 m for technological functions
• Cable length unshielded, max.	600 m; For technological functions: No	600 m; For technological functions: No	600 m; For technological functions: No	600 m; For technological functions: No	600 m; For technological functions: No	600 m; For technological functions: No
• Technological functions - shielded, max. - unshielded, max.	100 m not allowed	100 m not allowed	100 m not allowed	100 m not allowed	50 m not allowed	50 m not allowed
• Standard-DI - shielded, max. - unshielded, max.	1,000 m 600 m	1,000 m 600 m	1,000 m 600 m	1,000 m 600 m	1,000 m 600 m	1,000 m 600 m
Input characteristic curve to IEC 1131, type 1	Yes	Yes	Yes	Yes	Yes	Yes
Input voltage						
• Rated value, DC	24 V	24 V	24 V	24 V	24 V	24 V
• for signal "0"	-3 to 5 V	-3 to 5 V	-3 to 5 V	-3 to 5 V	-3 to 5 V	-3 to 5 V
• for signal "1"	15 to 30 V	15 to 30 V	15 to 30 V	15 to 30 V	15 to 30 V	15 to 30 V
Input current						
• for signal "1", typ.	9 mA	9 mA	9 mA	9 mA	9 mA	9 mA
Input delay (for rated value of input voltage)						
• for standard inputs - programmable - Rated value	Yes; 0.1 / 0.3 / 3 / 15 ms 3 ms	Yes; 0.1 / 0.3 / 3 / 15 ms 3 ms	Yes; 0.1 / 0.3 / 3 / 15 ms 3 ms	Yes; 0.1 / 0.3 / 3 / 15 ms 3 ms	Yes; 0.1 / 0.3 / 3 / 15 ms 3 ms	Yes; 0.1 / 0.3 / 3 / 15 ms 3 ms
• for counter/technological functions - at "0" to "1", max.	48 µs	16 µs	16 µs	16 µs	8 µs	8 µs
Digital outputs						
Number of digital outputs	6	16	16	16	16	16
• of which, high-speed outputs	2	4	4	4	4	4
Cable length, shielded, max.	1,000 m	1,000 m	1,000 m	1,000 m	1,000 m	1,000 m
Cable length unshielded, max.	600 m	600 m	600 m	600 m	600 m	600 m
Short-circuit protection of the output						
• Response threshold, typ.	1 A	1 A	1 A	1 A	1 A	1 A
Limitation of inductive shutdown voltage to	L+ (-48 V)	L+ (-48 V)	L+ (-48 V)	L+ (-48 V)	L+ (-48 V)	L+ (-48 V)
Lamp load, max.	5 W	5 W	5 W	5 W	5 W	5 W
Controlling a digital input	Yes	Yes	Yes	Yes	Yes	Yes

SIMATIC S7-300

Central processing units

Compact CPUs

Technical specifications (continued)

	6ES7 312-5BE03-0AB0	6ES7 313-5BF03-0AB0	6ES7 313-6BF03-0AB0	6ES7 313-6CF03-0AB0	6ES7 314-6BG03-0AB0	6ES7 314-6CG03-0AB0
Output voltage						
• for signal "1", min.	L+ (-0.8 V)	L+ (-0.8 V)	L+ (-0.8 V)	L+ (-0.8 V)	L+ (-0.8 V)	L+ (-0.8 V)
Output current						
• for signal "1" rated value	500 mA	500 mA	500 mA	500 mA	500 mA	500 mA
• for signal "1" permissible range, min.	5 mA	5 mA	5 mA	5 mA	5 mA	5 mA
• for signal "1" permissible range, max.	0.6 A	0.6 A	0.6 A	0.6 A	0.6 A	0.6 A
• for signal "1" minimum load current	5 mA	5 mA	5 mA	5 mA	5 mA	5 mA
• for signal "0" residual current, max.	0.5 mA	0.5 mA	0.5 mA	0.5 mA	0.5 mA	0.5 mA
Parallel switching of 2 outputs						
• for increased power	No	No	No	No	No	No
• for redundant control of a load	Yes	Yes	Yes	Yes	Yes	Yes
Switching frequency						
• with resistive load, max.	100 Hz	100 Hz	100 Hz	100 Hz	100 Hz	100 Hz
• with inductive load, max.	0.5 Hz	0.5 Hz	0.5 Hz	0.5 Hz	0.5 Hz	0.5 Hz
• on lamp load, max.	100 Hz	100 Hz	100 Hz	100 Hz	100 Hz	100 Hz
• of the pulse outputs, with resistive load, max.	2.5 kHz	2.5 kHz	2.5 kHz	2.5 kHz	2.5 kHz	2.5 kHz
Aggregate current of the outputs (per group)						
• vertical installation - up to 40 °C, max.	1.5 A	2 A	2 A	2 A	2 A	2 A
• horizontal installation - up to 40 °C, max. - up to 60 °C, max.	2 A 1.5 A	3 A 2 A	3 A 2 A	3 A 2 A	3 A 2 A	3 A 2 A
Load impedance range						
• lower limit	48 Ω	48 Ω	48 Ω	48 Ω	48 Ω	48 Ω
• upper limit	4 kΩ	4 kΩ	4 kΩ	4 kΩ	4 kΩ	4 kΩ
Analog inputs						
Number of analog inputs for voltage/current measurement		4			4	4
Number of analog inputs for resistance/temperature measurement		1			1	1
Cable length, shielded, max.		100 m			100 m	100 m
permissible input frequency for voltage input (destruction limit), max.		30 V; permanent			30 V; permanent	30 V; permanent
permissible input frequency for current input (destruction limit), max.		2.5 V; permanent			2.5 V; permanent	2.5 V; permanent
permissible input frequency for voltage input (destruction limit), max.		0.5 mA; permanent			0.5 mA; permanent	0.5 mA; permanent
permissible input current for current input (destruction limit), max.		50 mA; permanent			50 mA; permanent	50 mA; permanent
technical unit for temperature measurement, adjustable		Yes; Degrees Celsius / degrees Fahrenheit / Kelvin			Yes; Degrees Celsius / degrees Fahrenheit / Kelvin	Yes; Degrees Celsius / degrees Fahrenheit / Kelvin

SIMATIC S7-300

Central processing units

Compact CPUs
4
Technical specifications (continued)

	6ES7 312-5BE03-0AB0	6ES7 313-5BF03-0AB0	6ES7 313-6BF03-0AB0	6ES7 313-6CF03-0AB0	6ES7 314-6BG03-0AB0	6ES7 314-6CG03-0AB0
Input ranges (rated values), voltages						
• 0 to +10 V		Yes			Yes	Yes
• -10 V to +10 V		Yes			Yes	Yes
Input ranges (rated values), currents						
• 0 to 20 mA		Yes			Yes	Yes
• -20 to +20 mA		Yes			Yes	Yes
• 4 to 20 mA		Yes			Yes	Yes
Input ranges (rated values), resistors						
• No-Load voltage, typ.		2.5 V			2.5 V	2.5 V
• Measured current, typ.		1.8 mA to 3.3 mA			1.8 mA to 3.3 mA	1.8 mA to 3.3 mA
• 0 to 600 Ohm		Yes			Yes	Yes
Input ranges (rated values), resistance thermometers						
• Pt 100		Yes			Yes	Yes
Characteristic linearization						
• programmable		Yes; software			Yes; software	Yes; software
• for thermoresistor		Pt 100			Pt 100	Pt 100
Temperature compensation						
• programmable		No			No	No
Analog outputs						
Number of analog outputs		2			2	2
Cable length, shielded, max.		200 m			200 m	200 m
Voltage output, short-circuit protection		Yes			Yes	Yes
Voltage output, short-circuit current, max.		55 mA			55 mA	55 mA
Current output, no-load voltage, max.		17 V			17 V	17 V
Output ranges, voltage						
• 0 to 10 V		Yes			Yes	Yes
• -10 to +10 V		Yes			Yes	Yes
Output ranges, current						
• 0 to 20 mA		Yes			Yes	Yes
• -20 to +20 mA		Yes			Yes	Yes
• 4 to 20 mA		Yes			Yes	Yes
Connection of actuators						
• for voltage output 2-conductor connection		Yes; without compensation of the line resistances			Yes; without compensation of the line resistances	Yes; without compensation of the line resistances
• for voltage output 4-conductor connection		No			No	No
• for current output 2-conductor connection		Yes			Yes	Yes
Load impedance (in rated range of output)						
• with voltage outputs, min.		1 kΩ			1 kΩ	1 kΩ

SIMATIC S7-300

Central processing units

Compact CPUs

Technical specifications (continued)

	6ES7 312-5BE03-0AB0	6ES7 313-5BF03-0AB0	6ES7 313-6BF03-0AB0	6ES7 313-6CF03-0AB0	6ES7 314-6BG03-0AB0	6ES7 314-6CG03-0AB0
<ul style="list-style-type: none"> with voltage outputs, capacitive load, max. with current outputs, max. with current outputs, inductive load, max. 		0.1 µF 300 Ω 0.1 mH			0.1 µF 300 Ω 0.1 mH	0.1 µF 300 Ω 0.1 mH
Destruction limits against externally applied voltages and currents <ul style="list-style-type: none"> Voltages at the outputs towards MANA Current, max. 		16 V; permanent 50 mA; permanent			16 V; permanent 50 mA; permanent	16 V; permanent 50 mA; permanent
Analog value creation						
Measurement principle		Actual value encryption (successive approximation)			Actual value encryption (successive approximation)	Actual value encryption (successive approximation)
Integrations and conversion time/resolution per channel <ul style="list-style-type: none"> Resolution with overload area (bit including sign), max. Integration time, parameterizable permissible input frequency, max. Interference voltage suppression for interference frequency f_1 in Hz Conversion time (per channel) Time constant of the input filter Basic execution time of the module (all channels released) 		12 Bit Yes; 2,5 / 16,6 / 20 ms 400 Hz 400 / 60 / 50 Hz 1 ms 0.38 ms 1 ms			12 Bit Yes; 2,5 / 16,6 / 20 ms 400 Hz 400 / 60 / 50 Hz 1 ms 0.38 ms 1 ms	12 Bit Yes; 2,5 / 16,6 / 20 ms 400 Hz 400 / 60 / 50 Hz 1 ms 0.38 ms 1 ms
Settling time <ul style="list-style-type: none"> for resistive load for capacitive load for inductive load 		0.6 ms 1 ms 0.5 ms			0.6 ms 1 ms 0.5 ms	0.6 ms 1 ms 0.5 ms
Encoder						
Connection of signal encoders <ul style="list-style-type: none"> for voltage measurement for current measurement as 2-wire transducer for current measurement as 4-wire transducer for resistance measurement with 2-conductor connection for resistance measurement with 3-conductor connection for resistance measurement with 4-conductor connection 		Yes Yes; with external supply Yes Yes; without compensation of the line resistances No No			Yes Yes; with external supply Yes Yes; without compensation of the line resistances No No	Yes Yes; with external supply Yes Yes; without compensation of the line resistances No No
Connectable encoders <ul style="list-style-type: none"> 2-wire BEROs permissible quiescent current (2-wire BEROs), max. 	Yes 1.5 mA	Yes 1.5 mA	Yes 1.5 mA	Yes 1.5 mA	Yes 1.5 mA	Yes 1.5 mA

www.DataSheet4U.com
Technical specifications (continued)

	6ES7 312-5BE03-0AB0	6ES7 313-5BF03-0AB0	6ES7 313-6BF03-0AB0	6ES7 313-6CF03-0AB0	6ES7 314-6BG03-0AB0	6ES7 314-6CG03-0AB0
Errors/accuracies						
Output ripple (output range band width 0...50 kHz)		+/- 0.1 %			+/- 0.1 %	+/- 0.1 %
Linearity error (relative to output area)		+/- 0.15 %			+/- 0.15 %	+/- 0.15 %
Temperature error (relative to output area)		+/- 0.01 %/K			+/- 0.01 %/K	+/- 0.01 %/K
Temperature error (relative to input areas)		+/- 0.006 %/K			+/- 0.006 %/K	+/- 0.006 %/K
Crosstalk between the outputs, min.		60 dB			60 dB	60 dB
Crosstalk between the inputs, min.		60 dB			60 dB	60 dB
Repeat accuracy in settled status at 25 °C (relative to output area)		+/- 0.06 %			+/- 0.06 %	+/- 0.06 %
Repeat accuracy in settled status at 25 °C (relative to input area)		+/- 0.06 %			+/- 0.06 %	+/- 0.06 %
Operational limit in overall temperature range						
• Voltage, relative to output area		+/- 1 %			+/- 1 %	+/- 1 %
• Current, relative to output area		+/- 1 %			+/- 1 %	+/- 1 %
• Voltage, relative to input area		+/- 1 %			+/- 1 %	+/- 1 %
• Current, relative to input area		+/- 1 %			+/- 1 %	+/- 1 %
• Impedance, relative to input area		+/- 5 %			+/- 5 %	+/- 5 %
Basic error limit (operational limit at 25 °C)						
• Voltage, relative to output area		+/- 0.7 %			+/- 0.7 %	+/- 0.7 %
• Current, relative to output area		+/- 0.7 %			+/- 0.7 %	+/- 0.7 %
• Voltage, relative to input area		+/- 0.7 %; Linearity error +/- 0.06%			+/- 0.7 %; Linearity error +/- 0.06%	+/- 0.7 %; Linearity error +/- 0.06%
• Current, relative to input area		+/- 0.7 %; Linearity error +/- 0.06%			+/- 0.7 %; Linearity error +/- 0.06%	+/- 0.7 %; Linearity error +/- 0.06%
• Impedance, relative to input area		+/- 3 %; Linearity error +/- 0.2%			+/- 3 %; Linearity error +/- 0.2%	+/- 3 %; Linearity error +/- 0.2%
• Resistance-type thermometer, relative to input area		+/- 3 %			+/- 3 %	+/- 3 %
Interference voltage suppression for $f = n \times (f_l \pm 1 \%)$, f_l = interference frequency						
• Series mode interference (peak value of interference < rated value of input range), min.		30 dB			30 dB	30 dB
• common mode voltage, min.		40 dB			40 dB	40 dB

SIMATIC S7-300

Central processing units

Compact CPUs

Technical specifications (continued)

	6ES7 312-5BE03-0AB0	6ES7 313-5BF03-0AB0	6ES7 313-6BF03-0AB0	6ES7 313-6CF03-0AB0	6ES7 314-6BG03-0AB0	6ES7 314-6CG03-0AB0
Integrated Functions						
Number of counters	2; 2 channels (see "Technological Functions" manual)	3; 3 channels (see "Technological Functions" manual)	3; 3 channels (see "Technological Functions" manual)	3; 3 channels (see "Technological Functions" manual)	4; see "Technological Functions" manual	4; see "Technological Functions" manual
Counter frequency (counter) max.	10 kHz	30 kHz	30 kHz	30 kHz	60 kHz	60 kHz
Frequency measurement	Yes	Yes	Yes	Yes	Yes	Yes
Controlled positioning	No	No	No	No	Yes	Yes
PID controller	No	Yes	Yes	Yes	Yes	Yes
Number of pulse outputs	2; 2 channels pulse width modulation up to 2.5 kHz (see Manual "Technological Functions")	3; 3 channels pulse width modulation up to 2.5 kHz (see Manual "Technological Functions")	3; 3 channels pulse width modulation up to 2.5 kHz (see Manual "Technological Functions")	3; 3 channels pulse width modulation up to 2.5 kHz (see Manual "Technological Functions")	4; Pulse width modulation up to 2.5 kHz (see "Technological Functions" Manual)	4; Pulse width modulation up to 2.5 kHz (see "Technological Functions" Manual)
Limit frequency (pulse)	2.5 kHz	2.5 kHz	2.5 kHz	2.5 kHz	2.5 kHz	2.5 kHz
Isolation						
Isolation, analog outputs						
• Galvanic isolation, analog outputs		Yes			Yes	Yes
• between the channels		No			No	No
• between the channels and the backplane bus		Yes			Yes	Yes
Isolation, analog inputs						
• Isolation, analog inputs		Yes			Yes	Yes
• between the channels		No			No	No
• between the channels and the backplane bus		Yes			Yes	Yes
Isolation, digital outputs						
• Galvanic isolation, digital outputs	Yes	Yes	Yes	Yes	Yes	Yes
• between the channels	No	Yes	Yes	Yes	Yes	Yes
• between the channels, in groups of	6	8	8	8	8	8
• between the channels and the backplane bus	Yes	Yes	Yes	Yes	Yes	Yes
Galvanic isolation, digital inputs						
• galvanic isolation, digital inputs	Yes	Yes	Yes	Yes	Yes	Yes
• between the channels	No	No	No	No	No	No
• between the channels, in groups of	10					
• between the channels and the backplane bus	Yes	Yes	Yes	Yes	Yes	Yes
Dimensions and weight						
Width	80 mm	120 mm	120 mm	120 mm	120 mm	120 mm
Height	125 mm	125 mm	125 mm	125 mm	125 mm	125 mm
Depth	130 mm	130 mm	130 mm	130 mm	130 mm	130 mm
Weights						
Weight, approx.	409 g	660 g	566 g	566 g	676 g	676 g

SIMATIC S7-300

Central processing units

Compact CPUs

4

Ordering data	Order No.	Order No.
CPU 312C Compact CPU, main memory 32 KB, power supply 24 V DC, 10 DI/6 DO integrated, integrated functions, MPI; including slot number labels and 2 keys; MMC is required	A) 6ES7 312-5BE03-0AB0	Sub-D connector for connection to the second serial interface of the CPU 31xC-2 PtP; 15 pin, pins
CPU 313C Compact CPU, main memory 64 KB, power supply 24 V DC, 24 DI/16 DO, 4 AI/2 AO integrated, integrated functions, MPI; MMC is required	A) 6ES7 313-5BF03-0AB0	Front connector (1 unit) for compact CPUs 40-pin, with screw contacts <ul style="list-style-type: none"> • 1 unit • 100 units 40-pin with cage clamp contacts <ul style="list-style-type: none"> • 1 unit • 100 units
CPU 313C-2 PtP Compact CPU, main memory 64 KB, power supply 24 V DC, 16 DI/16 DO integrated, integrated functions, MPI; RS 422/485 interface; MMC is required	A) 6ES7 313-6BF03-0AB0	SIMATIC TOP connect See page 4/225; Information about which components can be used for the respective module, see A&D Mall or Catalog KT 10.2
CPU 313C-2 DP Compact CPU, main memory 64 KB, power supply 24 V DC, 16 DI/16 DO integrated, integrated functions, MPI PROFIBUS DP master/slave interface; MMC is required	A) 6ES7 313-6CF03-0AB0	Slot number plates S7-300 manual Design, CPU data, module data, instruction list
CPU 314C-2 PtP Compact CPU, main memory 96 KB, power supply 24 V DC, 24DI/16DO/4AI/2AO integrated, integrated functions, MPI; RS 422/485 interface; MMC is required	A) 6ES7 314-6BG03-0AB0	German 6ES7 398-8FA10-8AA0 English 6ES7 398-8FA10-8BA0 French 6ES7 398-8FA10-8CA0 Spanish 6ES7 398-8FA10-8DA0 Italian 6ES7 398-8FA10-8EA0
CPU 314C-2 DP Compact CPU, main memory 96 KB, power supply 24 V DC, 24DI/16DO/4AI/2AO integrated, integrated functions, MPI; PROFIBUS DP master/slave interface; MMC is required	A) 6ES7 314-6CG03-0AB0	SIMATIC Manual Collection D) 6ES7 998-8XC01-8YE0 Electronic manuals on DVD, multilingual: S7-200, S7-300, C7, S7-400, SIMATIC DP (Distributed I/O), SIMATIC PC, SIMATIC PG (Programming device), STEP 7, Engineering Tools, Runtime Software, SIMATIC PCS 7, SIMATIC HMI (Human Machine Interface), SIMATIC NET (Industrial Communication), SIMATIC Machine Vision, SIMATIC Sensors
Micro Memory Card 64 KB 128 KB 512 KB 2 MB 4 MB 8 MB	6ES7 953-8LF11-0AA0 6ES7 953-8LG11-0AA0 6ES7 953-8LJ11-0AA0 6ES7 953-8LL11-0AA0 6ES7 953-8LM11-0AA0 6ES7 953-8LP11-0AA0	SIMATIC Manual Collection update service for 1 year D) 6ES7 998-8XC01-8YE2 Current "Manual Collection" DVD and the three subsequent updates
MPI cable For connecting SIMATIC S7 and the PG through MPI; 5 m in length	6ES7 901-0BF00-0AA0	Power supply connector For compact CPUs, innovated standard CPUs and CPU 315F-2 DP (10 units, spare part)
Point-to-point link cable for connection to CPU 31xC-2 PtP 5 m 10 m 50 m	6ES7 902-3AB00-0AA0 6ES7 902-3AC00-0AA0 6ES7 902-3AG00-0AA0	Labeling strips For compact CPUs, standard CPUs as well as CPU 315F-2 DP (10 units, spare part)
		Label cover For compact CPUs, standard CPUs as well as CPU 315F-2 DP (10 units, spare part)

A) Subject to export regulations: AL: N and ECCN: EAR99H

D) Subject to export regulations: AL: N and ECCN: 5D992B1

SIMATIC S7-300

Central processing units

Compact CPUs

Ordering data (continued)

S7 SmartLabel

Software for automatic labeling of modules based on data of the STEP 7 project

Order No.
2XV9 450-1SL01-0YX0

Labeling sheets for machine inscription

For 16-channel signal modules, DIN A4, for printing with laser printer;

10 units

petrol

light-beige

yellow

red

6ES7 392-2AX00-0AA0

6ES7 392-2BX00-0AA0

6ES7 392-2CX00-0AA0

6ES7 392-2DX00-0AA0

For 32-channel signal modules, DIN A4, for printing with laser printer;

10 units

petrol

light-beige

yellow

red

6ES7 392-2AX10-0AA0

6ES7 392-2BX10-0AA0

6ES7 392-2CX10-0AA0

6ES7 392-2DX10-0AA0

PROFIBUS DP bus connector RS 485

- With 90° cable outlet, max. transmission rate 12 Mbit/s

- without PG interface

- with PG interface

6ES7 972-0BA12-0XA0

6ES7 972-0BB12-0XA0

- With 90° cable outlet for FastConnect connection system, max. transmission rate 12 Mbit/s

- without PG interface

- with PG interface

6ES7 972-0BA50-0XA0

6ES7 972-0BB50-0XA0

- With axial cable outlet for SIMATIC OP, for connecting to PPI, MPI, PROFIBUS

6GK1 500-0EA02

PROFIBUS Fast Connect bus cable

Standard type with special design for quick mounting, 2-core, shielded, sold by the meter, max. delivery unit 1000 m, minimum ordering quantity 20 m

6XV1 830-0EH10

RS 485 repeater for PROFIBUS

Data transfer rate up to 12 Mbit/s; 24 V DC; IP20 housing

6ES7 972-0AA01-0XA0

PROFIBUS bus components

For establishing MPI/PROFIBUS communication

see Catalogs IK PI, CA 01

4

SIMATIC S7-300

Central processing units

Standard CPUs

4

Overview CPU 312



- The starter CPU for Totally Integrated Automation (TIA).
- For small-scale applications with moderate requirements on the processing speed.

Micro memory card required to operate the CPU.

Overview CPU 315-2 DP



- The CPU with medium to large program memory and quantity framework for the use, if required, of SIMATIC Engineering Tools
- High processing performance in binary and floating-point arithmetic
- PROFIBUS DP master/slave interface
- For extensive I/O configurations
- For setting up distributed I/O structures

Micro memory card required for operation of CPU.

Overview CPU 314



- For installations with medium requirements on program scope
- High processing performance in binary and floating-point arithmetic

Micro memory card is required to operate the CPU.

Overview CPU 315-2 PN/DP



- The CPU with a medium program memory and quantity framework
- High processing performance in binary and floating-point arithmetic
- Used as a central controller on production lines with central and distributed I/O
- Integral PROFINET interface
- Combined MPI / PROFIBUS DP-master/slave interface
- Component Based Automation (CBA) on PROFINET
- PROFINET proxy for intelligent devices on PROFIBUS DP in Component Based Automation (CBA)
- PROFINET IO Controller for operating distributed I/O on PROFINET

Micro Memory Card required for operation of CPU.

www.DataSheet4U.com

SIMATIC S7-300

Central processing units

Standard CPUs

Overview CPU 317-2 DP



- The CPU with a large program memory and quantity framework for demanding requirements
- For multisector automation tasks in the construction of series machines, special machines and plants
- Used as a central controller on production lines with central and distributed I/O
- High processing performance in binary and floating-point arithmetic
- PROFIBUS DP master/slave interface
- For extensive I/O configurations
- For setting up distributed I/O structures
- Supports as an option the use of SIMATIC Engineering Tools
- Distributed intelligence in Component Based Automation (CBA) on PROFIBUS DP

Micro memory card required for operation of CPU.

Overview CPU 317-2 PN/DP



- The CPU with a large program memory and quantity framework for demanding requirements
- Distributed intelligence in Component Based Automation (CBA) on PROFINET
- PROFINET proxy for intelligent devices on PROFIBUS DP in Component Based Automation (CBA)
- PROFINET I/O controller for operating distributed I/O on PROFINET
- For multisector automation tasks in the construction of series machines, special machines and plants
- Used as a central controller on production lines with central and distributed I/O
- For extensive I/O configurations
- For setting up distributed I/O structures
- High processing performance in binary and floating-point arithmetic
- Combined MPI/PROFIBUS DP-master/slave interface
- Supports as an option the use of SIMATIC Engineering Tools

Micro memory card required for operation of CPU.

Overview CPU 319-3 PN/DP



- The CPU with high command processing performance, large program memory and quantity framework for demanding applications
- For cross-sector automation tasks in series machine, special machine and plant construction
- Used as central controller in production lines with central and distributed I/O on PROFIBUS and PROFINET
- Distributed intelligence in Component Based Automation (CBA) on PROFINET
- PROFINET proxy for intelligent devices on PROFIBUS DP in Component Based Automation (CBA)
- Isochronous mode on PROFIBUS
- Optionally supports the use of SIMATIC engineering tools

Micro Memory Card required for operation of CP

Technical specifications

	6ES7 312-1AE13-0AB0	6ES7 314-1AG13-0AB0	6ES7 315-2AG10-0AB0	6ES7 315-2EH13-0AB0
Product status				
Associated programming package	STEP7 V5.2 or higher + SP1 with HW update	STEP7 V5.2 or higher + SP1 with HW update	STEP 7 V 5.1 or higher + SP 4	STEP 7 V5.3 SP1 with hardware update
Supply voltages				
Rated value				
• DC 24 V	Yes	Yes	Yes	Yes
• permissible range, lower limit (DC)	20.4 V	20.4 V	20.4 V	20.4 V
• permissible range, upper limit (DC)	28.8 V	28.8 V	28.8 V	28.8 V
Voltagages and currents				
External protection for supply cables (recommendation)	min. 2 A	min. 2 A	min. 2 A	min. 2 A
Current consumption				
Inrush current, typ.	2.5 A	2.5 A	2.5 A	2.5 A
I ² t	0.5 A ² s	0.5 A ² s	0.5 A ² s	1 A ² s
Current consumption (in no-load operation), typ.	60 mA	60 mA	60 mA	100 mA
Current consumption (rated value)	0.6 A	0.6 A		650 mA
from supply voltage L+, max.	600 mA	600 mA	800 mA	
Power loss, typ.	2.5 W	2.5 W	2.5 W	3.5 W
Memory				
Memory				
• RAM				
- integrated	32 KByte; for program and data, less the display data	96 KByte; for program and data, less the display data	128 KByte	256 KByte; for program and data, less the display data
- expandable	No	No	No	No
• Load memory				
- pluggable (MMC)	Yes	Yes	Yes	Yes
- pluggable (MMC), max.	4 MByte	8 MByte	8 MByte	8 MByte
Backup				
• present	Yes; guaranteed by MMC (maintenance-free)	Yes; guaranteed by MMC (maintenance-free)	Yes; guaranteed by MMC (maintenance-free)	Yes; guaranteed by MMC (maintenance-free)
• without battery	Yes; Program and data	Yes; Program and data		Yes; Program and data

SIMATIC S7-300

Central processing units

Standard CPUs

Technical specifications (continued)

	6ES7 312-1AE13-0AB0	6ES7 314-1AG13-0AB0	6ES7 315-2AG10-0AB0	6ES7 315-2EH13-0AB0
CPU/blocks				
DB				
• Number, max.	511; Number band: 1 to 511	511; Number band: 1 to 511	1,024; Number band: 1 to 1023	1,023; Number band: 1 to 1023
• Size, max.	16 KByte	16 KByte	16 KByte	16 KByte
FB				
• Number, max.	1,024; Number band: 0 to 2047	1,024; Number band: 0 to 2047	2,048; Number band: 0 to 2047	1,024; Number band: 0 to 2047
• Size, max.	16 KByte	16 KByte	16 KByte	16 KByte
FC				
• Number, max.	1,024; Number band: 0 to 2047	1,024; Number band: 0 to 2047	2,048; Number band: 0 to 2047	1,024; Number band: 0 to 2047
• Size, max.	16 KByte	16 KByte	16 KByte	16 KByte
OB				
• Number, max.	see Operation List	see Operation List		see Operation List
• Size, max.	16 KByte	16 KByte	16 KByte	16 KByte
Nesting depth				
• per priority class	8	8	8	8
• additional within an error OB	4	4	4	4
CPU/processing times				
for bit operations, min.	0.2 µs	0.1 µs	0.1 µs	0,1 µs
for word operations, min.	0.4 µs	0.2 µs	0.2 µs	0.2 µs
for fixed point arithmetic, min.	5 µs	2 µs	2 µs	2 µs
for floating point arithmetic, min.	6 µs	3 µs	3 µs	3 µs
Times/counters and their remanence				
S7 counter				
• Number	128	256	256	256
• of which remanent without battery				
- adjustable	Yes	Yes	Yes	Yes
- lower limit	0	0		0
- upper limit	127	255		255
• Remanence				
- adjustable	Yes	Yes	Yes	Yes
- lower limit	0	0		0
- upper limit	127	255		255
• Counting range				
- adjustable	Yes	Yes	Yes	Yes
- lower limit	0	0	0	0
- upper limit	999	999	999	999
IEC counter				
• present	Yes	Yes	Yes	Yes
• Type	SFB	SFB	SFB	SFB
S7 times				
• Number	128	256	256	256
• Remanence				
- adjustable	Yes	Yes	Yes	Yes
- lower limit	0	0		0
- upper limit	127	255		255
- preset	No retentivity	No retentivity	No retentivity	No retentivity
• Time range				
- lower limit	10 ms	10 ms	10 ms	10 ms
- upper limit	9,990 s	9,990 s	9,990 s	9,990 s

SIMATIC S7-300

Central processing units

Standard CPUs
4
Technical specifications (continued)

	6ES7 312-1AE13-0AB0	6ES7 314-1AG13-0AB0	6ES7 315-2AG10-0AB0	6ES7 315-2EH13-0AB0
IEC timer				
• present	Yes	Yes	Yes	Yes
• Type	SFB	SFB	SFB	SFB
Data areas and their remanence				
Flag				
• Number, max.	128 Byte	256 Byte	2,048 Byte	2,048 Byte
• Remanence available	Yes; MB 0 to MB 127	Yes; MB 0 to MB 255	Yes; MB 0 to MB 2047	Yes; MB 0 to MB 2047
• Number of clock memories	8; 1 memory byte	8; 1 memory byte	8; 1 memory byte	8; 1 memory byte
Data blocks				
• Number, max.	511; from DB1 to DB511	511; from DB1 to DB511	1,023; from DB 1 to DB 1023	1,023; from DB 1 to DB 1023
• Size, max.	16 KByte	16 KByte	16 KByte; Local data size: max. 1024 bytes per priority class/ 510 bytes per block	16 KByte
• Remanence adjustable	Yes; via non-retain property on DB	Yes; via non-retain property on DB		Yes; via non-retain property on DB
• Remanence preset	Yes	Yes		Yes
Local data				
• per priority class, max.	256 Byte	510 Byte	128 Byte	1,024 Byte; per block max. 510
Address area				
I/O address area				
• Inputs	1 KByte	1 KByte	2 KByte	2 KByte
• Outputs	1 KByte	1 KByte	2 KByte	2 KByte
• of which, distributed				
- Inputs			2 KByte	2 KByte
- Outputs			2 KByte	2 KByte
Process image				
• Inputs	128 Byte	128 Byte	128 Byte	128 Byte
• Outputs	128 Byte	128 Byte	128 Byte	128 Byte
Digital channels				
• Inputs	256	1,024	16,384	16,384
• Outputs	256	1,024	16,384	16,384
• Inputs, of which central	256	1,024	1,024	1,024; max.
• Outputs, of which central	256	1,024	1,024	1,024; max.
Analog channels				
• Inputs	64	256	1,024	1,024
• Outputs	64	256	1,024	1,024
• Inputs, of which central	64	256	256	256; max.
• Outputs, of which central	64	256	256	256; max.
Hardware config.				
Central devices, max.	1	1		1
Expansion devices, max.	0	3		3
Racks, max.	1	4	4	4
Modules per rack, max.	8	8	8	8
Number of DP masters				
• integrated	0	0	1	1
• via CP	4	4	4	4

SIMATIC S7-300

Central processing units

Standard CPUs

Technical specifications (continued)

	6ES7 312-1AE13-0AB0	6ES7 314-1AG13-0AB0	6ES7 315-2AG10-0AB0	6ES7 315-2EH13-0AB0
Number of operable FMs and CPs (recommended)				
• FM	8	8	8	8
• CP, point-to-point	8	8	8	8
• CP, LAN	4	10	10	10
Time				
Clock				
• Hardware clock (real-time clock)		Yes	Yes	Yes
• Software clock	Yes			
• Battery backed and synchronized	No	Yes	Yes	Yes
• Deviation per day, max.	15 s	10 s	10 s	10 s
Operating hours counter				
• Number	1	1	1	1
• Number/Number range	0	0	0	0
• Range of values	0 to 2 ³¹ hours (when using SFC101)	0 to 2 ³¹ hours (when using SFC101)	0 to 2 ³¹ hours (when using SFC101)	2 ³¹ hours (when using the SFC 101)
• Granularity	1 hour	1 hour	1 hour	1 hour
• remanent	Yes; must be restarted at each warm restart	Yes; must be restarted at each warm restart	Yes; must be restarted at each warm restart	Yes; must be restarted at each warm restart
Clock synchronization				
• supports	Yes	Yes	Yes	Yes
• to MPI, Master	Yes	Yes	Yes	Yes
• to MPI, Slave	Yes	Yes	Yes	Yes
• in AS, Master	Yes	Yes	Yes	Yes
• in AS, Slave				Yes
S7 message functions				
Number of login stations for message functions, max.	6; depending on the configured connections for PG/OP and S7 basic communication	12; depending on the configured connections for PG/OP and S7 basic communication	16; depending on the configured connections for PG-/ OP- and S7-basic communication	16; (depending on the configured connections for PG-/OP and S7 basic communication)
Process diagnostic messages	Yes	Yes	Yes	Yes
Simultaneously active Alarm-S blocks, max.	20	40	40	40
Test commissioning functions				
Status/control				
• Status/control variable	Yes	Yes	Yes	Yes
• Variables	Inputs, outputs, memory bits, DB, times, counters	Inputs, outputs, memory bits, DB, times, counters	Inputs, outputs, memory bits, DB, times, counters	Inputs, outputs, memory bits, DB, times, counters
Monitoring functions				
• Number of variables, max.	30	30	30	30
• of which status variable, max.	30	30	30	30
• of which control variable, max.	14	14	14	14
Forcing				
• Forcing	Yes	Yes	Yes	Yes
• Force, variables	Inputs, outputs	Inputs, outputs	Inputs, outputs	Inputs, outputs
• Forcing, number of variables, max.	10	10	10	10
Status block	Yes	Yes	Yes	Yes
Single step	Yes	Yes	Yes	Yes
Number of breakpoints	2	2	2	2

SIMATIC S7-300

Central processing units

Standard CPUs
4
Technical specifications (continued)

	6ES7 312-1AE13-0AB0	6ES7 314-1AG13-0AB0	6ES7 315-2AG10-0AB0	6ES7 315-2EH13-0AB0
Monitoring functions				
Diagnostic buffer				
• present	Yes	Yes	Yes	Yes
• Number of entries, max.	100	100	100	100
• adjustable	No	No	No	No
Communication functions				
PG/OP communication	Yes	Yes	Yes	Yes
Routing	No	No	Yes	Yes
Global data communication				
• supported	Yes	Yes	Yes	Yes
• Size of GD packets, max.	22 Byte	22 Byte	22 Byte	22 Byte
S7 basic communication				
• supported	Yes	Yes	Yes	Yes
S7 communication				
• supported	Yes	Yes	Yes	Yes
S5-compatible communication				
• supported	Yes; via CP and loadable FC	Yes; via CP and loadable FC	Yes; via CP and loadable FC	Yes; via CP and loadable FC
Open IE communication				
• TCP/IP				Yes; via integrated PROFINET interface and loadable FBs
- Number of connections, max.				8
- Data length, max.				1,460 Byte
Number of connections				
• overall	6	12	16	16
• usable for PG communication	5	11	15	15; max.
• usable for OP communication	5	11	15	15
• usable for S7 basic communication	2	8	12	14
• usable for routing			4	
PROFINET CBA (at set setpoint communication load)				
• Setpoint for the CPU communication load				50%
• Number of remote interconnection partners				32
• Number of functions, master/slave				17
• Total of all master/slave connections				1,000
• Data length of all incoming connections master/slave, max.				4,000 Byte
• Data length of all outgoing connections master/slave, max.				4,000 Byte
• Number of device-internal and PROFIBUS interconnections				500
• Data length of device-internal und PROFIBUS interconnections, max.				4,000 Byte
• Data length per connection, max.				1,400 Byte

SIMATIC S7-300

Central processing units

Standard CPUs

Technical specifications (continued)

	6ES7 312-1AE13-0AB0	6ES7 314-1AG13-0AB0	6ES7 315-2AG10-0AB0	6ES7 315-2EH13-0AB0
PROFINET CBA (at set setpoint communication load) <ul style="list-style-type: none"> Remote interconnections with acyclic transmission <ul style="list-style-type: none"> - Sampling frequency: sampling interval, min. - Number of incoming interconnections - Number of outgoing interconnections - Data length of all incoming interconnections, max. - Data length of all outgoing interconnections, max. - Data length per connection, max. 				500 ms 100 100 2,000 Byte 2,000 Byte 1,400 Byte
<ul style="list-style-type: none"> Remote interconnections with cyclic transmission <ul style="list-style-type: none"> - Transmission frequency: transmission interval, min. - Number of incoming interconnections - Data length of all incoming interconnections, max. - Data length of all outgoing interconnections, max. - Data length per connection, max. 				10 ms 200 2,000 Byte 2,000 Byte 450 Byte
<ul style="list-style-type: none"> HMI variables via PROFINET (acyclic) <ul style="list-style-type: none"> - Number of log-in stations for HMI variables (PN OPC/iMap) - HMI variable updating - Number of HMI variables - Data length of all HMI variables, max. 				3; 2 * PN OPC / 1 * iMap 500 ms 200 2,000 Byte
<ul style="list-style-type: none"> PROFIBUS proxy functionality <ul style="list-style-type: none"> - supported - Number of linked PROFIBUS devices - Data length per connection, max. 				Yes 16 240 Byte; Slave-dependent
MPI				
Cable length, max.		50 m; without repeater		
1st interface				
Type of interface	Integral RS 485 interface	Integral RS 485 interface	Integral RS 485 interface	Integral RS 485 interface
Physics	RS 485	RS 485	RS 485	RS 485
isolated	No	No	No	Yes
Power supply to interface (15 to 30 V DC), max.	200 mA	200 mA	200 mA	200 mA
Functionality				
• MPI	Yes	Yes	Yes	Yes
• DP master	No	No	No	Yes
• DP slave	No	No	No	Yes
• Point-to-point coupling	No	No	No	No

SIMATIC S7-300

Central processing units

Standard CPUs
Technical specifications (continued)

	6ES7 312-1AE13-0AB0	6ES7 314-1AG13-0AB0	6ES7 315-2AG10-0AB0	6ES7 315-2EH13-0AB0
MPI				
• Number of connections	6	12	16	16
• Services				
- PG/OP communication	Yes	Yes	Yes	Yes
- Routing	No	No	Yes	Yes
- Global data communication	Yes	Yes	Yes	Yes
- S7 basic communication	Yes	Yes	Yes	Yes
- S7 communication	Yes	Yes	Yes	Yes
- S7 communication, as client	No	No	No	No
- S7 communication, as server	Yes	Yes	Yes	Yes
• Transmission speeds, max.	187.5 kBit/s	187.5 kBit/s	187.5 kBit/s	12 Mbit/s
DP master				
• Services				
- PG/OP communication				Yes
- Routing				Yes
- Global data communication				No
- S7 basic communication				Yes
- S7 communication				Yes
- S7 communication, as client				No
- S7 communication, as server				Yes
- equidistance support				Yes
- SYNC/FREEZE				Yes
- DPV1				Yes
• Transmission speeds, max.				12 Mbit/s
• Number of DP slaves, max.				124
DP slave				
• Services				
- Routing				Yes; only when interface active
- Global data communication				No
- S7 basic communication				Yes
- S7 communication				Yes
- S7 communication, as client				No
- S7 communication, as server				Yes
- direct data exchange (cross traffic)				Yes
- DPV1				No
• Transmission speeds, max.				12 Mbit/s
• Transfer memory				
- Inputs				244 Byte
- Outputs				244 Byte
• Address area, max.				32; with max. 32 bytes each
2nd interface				
Type of interface			Integral RS 485 interface	PROFINET
Physics			RS 485	Ethernet
isolated			Yes	Yes
Power supply to interface (15 to 30 V DC), max.			200 mA	0 mA
Automatic detection of transmission speed				Yes; (10/100 MBit/s)

4

SIMATIC S7-300

Central processing units

Standard CPUs

Technical specifications (continued)

	6ES7 312-1AE13-0AB0	6ES7 314-1AG13-0AB0	6ES7 315-2AG10-0AB0	6ES7 315-2EH13-0AB0
Functionality <ul style="list-style-type: none"> • MPI • DP master • DP slave • Point-to-point coupling • PROFINET CBA • PROFINET IO controller 			No Yes Yes No	No No No No Yes Yes
DP master <ul style="list-style-type: none"> • Number of connections, max. • Services <ul style="list-style-type: none"> - PG/OP communication - Routing - Global data communication - S7 basic communication - S7 communication - S7 communication, as client - S7 communication, as server - Equidistance support - SYNC/FREEZE - DPV1 			16 Yes Yes No Yes Yes No Yes Yes Yes Yes	
<ul style="list-style-type: none"> • Transmission speeds, max. • Number of DP slaves, max. • Address area <ul style="list-style-type: none"> - Inputs, max. - Outputs, max. 			12 Mbit/s 124; per station 244 Byte 244 Byte	
DP slave <ul style="list-style-type: none"> • Number of connections • Services <ul style="list-style-type: none"> - PG/OP communication - Routing - Global data communication - S7 basic communication - S7 communication, as client - S7 communication, as server - direct data exchange (cross traffic) - DPV1 			16 Yes Yes; when interface active No Yes No Yes Yes No	
<ul style="list-style-type: none"> • GSD file • Transmission speeds, max. • automatic baud rate search • Transfer memory <ul style="list-style-type: none"> - Inputs - Outputs 			http://www.ad.siemens.de/support in Product Support area 12 Mbit/s Yes; only with passive interface 244 Byte 244 Byte	
<ul style="list-style-type: none"> • Address area, max. • Useful data per address area, max. 			32 32 Byte	
PROFINET CBA <ul style="list-style-type: none"> • Acyclic transmission • cyclic transmission 				Yes Yes

SIMATIC S7-300

Central processing units

Standard CPUs

4

Technical specifications (continued)

	6ES7 312-1AE13-0AB0	6ES7 314-1AG13-0AB0	6ES7 315-2AG10-0AB0	6ES7 315-2EH13-0AB0
PROFINET IO controller				
<ul style="list-style-type: none"> Services <ul style="list-style-type: none"> - PG/OP communication - Routing - S7 communication - open IE communication 				Yes Yes Yes; with loadable FBs, max. configurable connections: 14, max. number of instances: 32 Yes; via TCP/IP
<ul style="list-style-type: none"> Transmission speed, max. Number of connectable IO-devices, max. Update time 				100 Mbit/s 128 1 to 512 ms (minimum value depends on communication share set for PROFINET IO, on the number of IO devices and on the number of configured useful data items)
<ul style="list-style-type: none"> Address area <ul style="list-style-type: none"> - Inputs, max. - Outputs, max. Useful data consistency, max. 				2 KByte 2 KByte 256 Byte
CPU/programming				
Programming language				
<ul style="list-style-type: none"> STEP 7 LAD FUP AWL SCL CFC GRAPH HiGraph 	Yes; V5.2 + SP1 or higher + hardware update Yes Yes Yes Yes Yes Yes Yes	Yes; V 5.2 SP 1 or higher with HW update Yes Yes Yes Yes Yes Yes Yes	Yes; V 5.1 SP4 or higher Yes Yes Yes Yes Yes Yes Yes	Yes; V 5.3 SP1 or higher + HW update Yes Yes Yes Yes Yes Yes Yes
Software libraries				
Operational stocks	See Operation List	See Operation List	See Operation List	See Operation List
Nesting levels	8	8	8	8
User program protection/password protection	Yes	Yes	Yes	Yes
System functions (SFC)	See Operation List	See Operation List	See Operation List	See Operation List
System function blocks (SFB)	See Operation List	See Operation List	See Operation List	See Operation List
Dimensions and weight				
Width	40 mm	40 mm	40 mm	80 mm
Height	125 mm	125 mm	125 mm	125 mm
Depth	130 mm	130 mm	130 mm	130 mm
Weights				
Weight, approx.	270 g	280 g	290 g	460 g

SIMATIC S7-300

Central processing units

Standard CPUs

Technical specifications (continued)

	6ES7 317-2AJ10-0AB0	6ES7 317-2EK13-0AB0	6ES7 318-3EL00-0AB0
Product status			
associated programming package	STEP 7 V5.2 + SP 1 or higher	STEP 7 V5.3 or higher with HW update	STEP 7 V5.3 or higher, Service pack 3 with HSP
Supply voltages			
Rated value			
• DC 24 V	Yes	Yes	Yes
• permissible range, lower limit (DC)	20.4 V	20.4 V	20.4 V
• permissible range, upper limit (DC)	28.8 V	28.8 V	28.8 V
Voltages and currents			
External protection for supply cables (recommendation)	Min. 2 A	Min. 2 A	min. 2 A
Current consumption			
Inrush current, typ.	2.5 A	2.5 A	4 A
I_t^2	1 A ² s	1 A ² s	1.2 A ² s
Current consumption (in no-load operation), typ.	100 mA	100 mA	400 mA
Current consumption (rated value)		650 mA	1,050 mA
Power loss, typ.	4 W	3.5 W	14 W
Memory			
Memory			
• RAM			
- integrated	512 KByte	1 MByte; for program and data, less the display data	1,400 KByte
- expandable	No	No	No
• Load memory			
- pluggable (MMC)	Yes	Yes	Yes
- pluggable (MMC), max.	8 MByte	8 MByte	8 MByte
Backup			
• present	Yes; Guaranteed by MMC (maintenance-free)	Yes; Guaranteed by MMC (maintenance-free)	Yes; up to 700 KB, maintenance-free
• without battery		Yes; Program and data	
CPU/blocks			
DB			
• Number, max.	2,048; Number band: 0 to 2047	2,048; Number band: 0 to 2047	2,048; Number band: 0 to 2047
• Size, max.	64 KByte	64 KByte	64 KByte
FB			
• Number, max.	2,048; Number band: 0 to 2047	2,048; Number band: 0 to 2047	2,048; Number band: 0 to 2047
• Size, max.	64 KByte	64 KByte	64 KByte
FC			
• Number, max.	2,048; Number band: 0 to 2047	2,048; Number band: 0 to 2047	2,048; Number band: 0 to 2047
• Size, max.	64 KByte	64 KByte	64 KByte
OB			
• Number, max.		see Operation List	
• Size, max.	64 KByte	64 KByte	64 KByte
Nesting depth			
• per priority class	16	16	16
• additional within an error OB	4	4	4

www.DataSheet4U.com
Technical specifications (continued)

	6ES7 317-2AJ10-0AB0	6ES7 317-2EK13-0AB0	6ES7 318-3EL00-0AB0
CPU/processing times			
for bit operations, min.	0.05 µs	0.05 µs	0.01 µs
for word operations, min.	0.2 µs	0.2 µs	0.02 µs
for fixed point arithmetic, min.	0.2 µs	0.2 µs	0.02 µs
for floating point arithmetic, min.	1 µs	1 µs	0.04 µs
Times/counters and their remanence			
S7 counter			
• Number	512	512	2,048
• of which remanent without battery			
- adjustable	Yes	Yes	
- lower limit		0	
- upper limit		511	
• Remanence			
- adjustable	Yes	Yes	Yes
- lower limit		0	
- upper limit		511	
• Counting range			
- adjustable	Yes	Yes	Yes
- lower limit	0	0	0
- upper limit	999	999	999
IEC counter			
• present	Yes	Yes	Yes
• Type	SFB	SFB	SFB
S7 times			
• Number	512	512	2,048
• Remanence			
- adjustable	Yes	Yes	Yes
- lower limit		0	
- upper limit		511	
- preset	No retentivity	No retentivity	No retentivity
• Time range			
- lower limit	10 ms	10 ms	10 ms
- upper limit	9,990 s	9,990 s	9,990 s
IEC timer			
• present	Yes	Yes	Yes
• Type	SFB	SFB	SFB
Data areas and their remanence			
Flag			
• Number, max.	4,096 Byte	4,096 Byte	8 KByte
• Remanence available	Yes; MB 0 to MB 4095	Yes; MB 0 to MB 4095	Yes; MB 0 to MB 8191
• Number of clock memories	8; 1 memory byte	8; 1 memory byte	8; 1 memory byte
Data blocks			
• Number, max.	2,047; from DB 1 to DB 2047	2,047; from DB 1 to DB 2047	4,095; from DB 1 to DB 2047
• Size, max.	64 KByte	64 KByte	64 KByte
• Remanence adjustable		Yes; via non-retain property on DB	Yes; via non-retain property on DB
• Remanence preset		Yes	
Local data			
• per priority class, max.	1,024 Byte	1,024 Byte	1,024 Byte

SIMATIC S7-300

Central processing units

Standard CPUs

Technical specifications (continued)

	6ES7 317-2AJ10-0AB0	6ES7 317-2EK13-0AB0	6ES7 318-3EL00-0AB0
Address area			
I/O address area			
• Inputs	8 KByte	8 KByte	8 KByte
• Outputs	8 KByte	8 KByte	8 KByte
• of which, distributed			
- Inputs	8,192 Byte	8 KByte	8 KByte
- Outputs	8,192 Byte	8 KByte	8 KByte
Process image			
• Inputs	256 Byte	2,048 Byte	
• Outputs	256 Byte	2,048 Byte	
• Inputs, adjustable		2,048 Byte	2 KByte
• Outputs, adjustable		2,048 Byte	2 KByte
• Inputs, preset		256 Byte	256 Byte
• Outputs, preset		256 Byte	256 Byte
Subprocess images			
• Number of subprocess images, max.			1
Digital channels			
• Inputs	65,536	65,536	65,536
• Outputs	65,536	65,536	65,536
• Inputs, of which central	1,024	1,024	1,024
• Outputs, of which central	1,024	1,024	1,024
Analog channels			
• Inputs	4,096	4,096	4,096
• Outputs	4,096	4,096	4,096
• Inputs, of which central	256	256	256
• Outputs, of which central	256	256	256
Hardware config.			
Central devices, max.		1	
Expansion devices, max.		3	
Racks, max.	4	4	4
Modules per rack, max.	8	8	8
Number of DP masters			
• integrated	2	1	2
• via CP	4	4	4
Number of operable FMs and CPs (recommended)			
• FM	8	8	8
• CP, point-to-point	8	8	8
• CP, LAN	10	10	10
Time			
Clock			
• Hardware clock (real-time clock)	Yes	Yes	Yes
• Battery backed and synchronized	Yes	Yes	Yes
• Deviation per day, max.	10 s	10 s	10 s

www.DataSheet4U.com
Technical specifications (continued)

	6ES7 317-2AJ10-0AB0	6ES7 317-2EK13-0AB0	6ES7 318-3EL00-0AB0
Operating hours counter			
• Number	4	4	4
• Number/Number range	0 to 3	0 to 3	0 to 3
• Range of values	0 to 2 ³¹ hours (when using SFC101)	0 to 2 ³¹ hours (when using SFC101)	0 to 2 ³¹ hours (when using SFC101)
• Granularity	1 hour	1 hour	1 hour
• remanent	Yes; must be restarted at each warm restart	Yes; must be restarted at each warm restart	Yes; must be restarted at each warm restart
Clock synchronization			
• supports	Yes	Yes	Yes
• to MPI, Master	Yes	Yes	Yes
• to MPI, Slave	Yes	Yes	Yes
• in AS, Master	Yes	Yes	Yes
• in AS, Slave	Yes	Yes	Yes
• on Ethernet via NTP			Yes
S7 message functions			
Number of login stations for message functions, max.	32; depending on the configured connections for PG/OP and S7 basic communication	32; depending on the configured connections for PG/OP and S7 basic communication	32; depending on the configured connections for PG/OP and S7 basic communication
Process diagnostic messages	Yes	Yes	Yes
Simultaneously active Alarm-S blocks, max.	60	60	60
Test commissioning functions			
Status/control			
• Status/control variable	Yes	Yes	Yes
• Variables	Inputs, outputs, memory bits, DB, times, counters	Inputs, outputs, memory bits, DB, times, counters	Inputs, outputs, memory bits, DB, times, counters
Monitoring functions			
• Number of variables, max.	30	30	30
• of which status variable, max.	30	30	30
• of which control variable, max.	14	14	14
Forcing			
• Forcing	Yes	Yes	Yes
• Force, variables	Inputs, outputs	Inputs, outputs	Inputs, outputs
• Forcing, number of variables, max.	10	10	10
Status block	Yes	Yes	Yes
Single step	Yes	Yes	Yes
Number of breakpoints	2	2	2
Diagnostic buffer			
• present	Yes	Yes	Yes
• Number of entries, max.	100	100	100
• adjustable	No	No	
Communication functions			
PG/OP communication	Yes	Yes	Yes
Routing	Yes	Yes	Yes
Global data communication			
• supported	Yes	Yes	Yes
• Size of GD packets, max.	22 Byte	22 Byte	22 Byte

SIMATIC S7-300

Central processing units

Standard CPUs

Technical specifications (continued)

	6ES7 317-2AJ10-0AB0	6ES7 317-2EK13-0AB0	6ES7 318-3EL00-0AB0
S7 basic communication			
• supported	Yes	Yes	Yes
S7 communication			
• supported	Yes	Yes	Yes
S5-compatible communication			
• supported	Yes; via CP and loadable FC	Yes; via CP and loadable FC	Yes; via CP and loadable FC
Open IE communication			
• TCP/IP		Yes; via integrated PROFINET interface and loadable FBs	Yes; via integrated PROFINET interface and loadable FBs
- Number of connections, max.		8	8
- Data length, max.		1,460 Byte	1,460 Byte
• ISO-on-TCP (RFC1006)			Yes; via integrated PROFINET interface and loadable FBs
- Number of connections, max.			8
- Data length, max.			8,192 Byte
• UDP			Yes; via integrated PROFINET interface and loadable FBs
- Number of connections, max.			8
- Data length, max.			1,472 Byte
Number of connections			
• overall	32	32	32
• usable for PG communication	31	31	31
• usable for OP communication	31	31	31
• usable for S7 basic communication	30	30	30
• usable for routing	8		
PROFINET CBA (at set setpoint communication load)			
• Setpoint for the CPU communication load		50%	
• Number of remote interconnection partners		32	
• Number of functions, master/slave		17	
• Total of all master/slave connections		1,000	
• Data length of all incoming connections master/slave, max.		4,000 Byte	
• Data length of all outgoing connections master/slave, max.		4,000 Byte	
• Number of device-internal and PROFIBUS interconnections		500	
• Data length of device-internal und PROFIBUS interconnections, max.		4,000 Byte	
• Data length per connection, max.		1,400 Byte	

SIMATIC S7-300

Central processing units

Standard CPUs
4
Technical specifications (continued)

	6ES7 317-2AJ10-0AB0	6ES7 317-2EK13-0AB0	6ES7 318-3EL00-0AB0
PROFINET CBA (at set setpoint communication load, continued)			
<ul style="list-style-type: none"> • Remote interconnections with acyclic transmission <ul style="list-style-type: none"> - Sampling frequency: sampling interval, min. - Number of incoming interconnections - Number of outgoing interconnections - Data length of all incoming interconnections, max. - Data length of all outgoing interconnections, max. - Data length per connection, max. • Remote interconnections with cyclic transmission <ul style="list-style-type: none"> - Transmission frequency: transmission interval, min. - Number of incoming interconnections - Data length of all incoming interconnections, max. - Data length of all outgoing interconnections, max. - Data length per connection, max. • HMI variables via PROFINET (acyclic) <ul style="list-style-type: none"> - Number of log-in stations for HMI variables (PN OPC/iMap) - HMI variable updating - Number of HMI variables - Data length of all HMI variables, max. • Remote interconnections with acyclic transmission <ul style="list-style-type: none"> - Sampling frequency: sampling interval, min. 	500 ms 100 100 2,000 Byte 2,000 Byte 1,400 Byte 10 ms 200 200 2,000 Byte 2,000 Byte 450 Byte 3; 2 * PN OPC / 1 * iMap 500 ms 200 2,000 Byte		
<ul style="list-style-type: none"> • PROFIBUS proxy functionality <ul style="list-style-type: none"> - supported - Number of linked PROFIBUS devices - Data length per connection, max. 		Yes 16 240 Byte; Slave-dependent	
1st interface			
Type of interface	Integral RS 485 interface	Integral RS 485 interface	Integral RS 485 interface
Physics	RS 485	RS 485	RS 485
isolated	Yes	Yes	Yes
Power supply to interface (15 to 30 V DC), max.	200 mA	200 mA	150 mA
Functionality			
<ul style="list-style-type: none"> • MPI • DP master • DP slave • Point-to-point coupling 	Yes Yes Yes No	Yes Yes Yes No	Yes Yes Yes No

SIMATIC S7-300

Central processing units

Standard CPUs

Technical specifications (continued)

	6ES7 317-2AJ10-0AB0	6ES7 317-2EK13-0AB0	6ES7 318-3EL00-0AB0
MPI			
• Number of connections	32	32	16
• Services			
- PG/OP communication	Yes	Yes	Yes
- Routing	Yes	Yes	Yes
- Global data communication	Yes	Yes	Yes
- S7 basic communication	Yes	Yes	Yes
- S7 communication	Yes	Yes	Yes
- S7 communication, as client	No	No	No
- S7 communication, as server	Yes	Yes	Yes
• Transmission speeds, max.	12 Mbit/s	12 Mbit/s	12 Mbit/s
DP master			
• Services			
- PG/OP communication	Yes	Yes	Yes
- Routing	Yes	Yes	Yes
- Global data communication	No	No	No
- S7 basic communication	Yes	Yes	Yes
- S7 communication	Yes	Yes	Yes
- S7 communication, as client		No	
- S7 communication, as server		Yes	
- Equidistance support	Yes	Yes	Yes
- SYNC/FREEZE	Yes	Yes	Yes
- DPV1	Yes	Yes	Yes
• Transmission speeds, max.	12 Mbit/s	12 Mbit/s	12 Mbit/s
• Number of DP slaves, max.	124	124	124
• Address area			
- Inputs, max.	244 Byte		244 KByte
- Outputs, max.	244 Byte		244 KByte
DP slave			
• Services			
- Routing	Yes; only when interface active	Yes; when interface active	Yes; when interface active
- Global data communication	No	No	No
- S7 basic communication	Yes	Yes	Yes
- S7 communication	Yes	Yes	Yes
- S7 communication, as client		No	
- S7 communication, as server		Yes	
- direct data exchange (cross traffic)	Yes	Yes	Yes
- DPV1	No	No	No
• Transmission speeds, max.	12 Mbit/s	12 Mbit/s	12 Mbit/s
• Transfer memory			
- Inputs	244 Byte	244 Byte	244 Byte
- Outputs	244 Byte	244 Byte	244 Byte
• Address area, max.	32	32	32
• Useful data per address area, max.	32 Byte	32 Byte	32 Byte
2nd interface			
Type of interface	Integral RS 485 interface	PROFINET	Integral RS 485 interface
Physics	RS 485	Ethernet	RS 485
isolated	Yes	Yes	Yes

SIMATIC S7-300

Central processing units

Standard CPUs

4

Technical specifications (continued)

	6ES7 317-2AJ10-0AB0	6ES7 317-2EK13-0AB0	6ES7 318-3EL00-0AB0
Power supply to interface (15 to 30 V DC), max.	200 mA	0 mA	200 mA
Automatic detection of transmission speed		Yes; (10/100 MBit/s)	
Functionality			
• MPI	No	No	No
• DP master	Yes	No	Yes
• DP slave	Yes	No	Yes
• Point-to-point coupling	No	No	No
• PROFINET CBA		Yes	No
• PROFINET IO controller		Yes; Firmware Status V2.3 or higher	No
DP master			
• Number of connections, max.	32		
• Services			
- PG/OP communication	Yes		Yes
- Routing	Yes		Yes
- Global data communication	No		No
- S7 basic communication	Yes		Yes
- S7 communication	Yes		Yes
- S7 communication, as client	No		
- S7 communication, as server	Yes		
- equidistance support	Yes		Yes
- SYNC/FREEZE	Yes		Yes
- DPV1	Yes		Yes
• Transmission speeds, max.	12 Mbit/s		12 Mbit/s
• Number of DP slaves, max.	124		124
• Address area			
- Inputs, max.	244 Byte		244 KByte
- Outputs, max.	244 Byte		244 KByte
DP slave			
• Number of connections	32		
• Services			
- PG/OP communication	Yes		Yes
- Routing	Yes; when interface active		Yes; when interface active
- Global data communication	No		No
- S7 basic communication	Yes		Yes
- S7 communication, as client	No		
- S7 communication, as server	Yes		
- direct data exchange (cross traffic)	Yes		Yes
- DPV1	No		No
• GSD file	http://www.ad.siemens.de/support in Product Support area		
• Transmission speeds, max.	12 Mbit/s		12 Mbit/s
• automatic baud rate search	Yes; only with passive interface		Yes; only with passive interface
• Transfer memory			
- Inputs	244 Byte		244 Byte
- Outputs	244 Byte		244 Byte
• Address area, max.	32		32
• Useful data per address area, max.	32 Byte		32 Byte

SIMATIC S7-300

Central processing units

Standard CPUs

Technical specifications (continued)

	6ES7 317-2AJ10-0AB0	6ES7 317-2EK13-0AB0	6ES7 318-3EL00-0AB0
PROFINET CBA			
• Acyclic transmission		Yes	
• Cyclic transmission		Yes	
PROFINET IO controller			
• Services		Yes	
- PG/OP communication		Yes	
- Routing		Yes; with loadable FBs, max. configurable connections: 16, max. number of instances: 32	
- S7 communication		Yes; via TCP/IP	
- open IE communication			
• Transmission speed, max.		100 Mbit/s	
• Number of connectable I/O-devices, max.		128	
• Update time		1 to 512 ms (minimum value depends on communication share set for PROFINET IO, on the number of IO devices and on the number of configured useful data items)	
• Address area			
- Inputs, max.		8 KByte	
- Outputs, max.		8 KByte	
• Useful data consistency, max.		256 Byte	
3rd interface			
Type of interfaces			PROFINET
Physics			RJ45
isolated			Yes
Automatic detection of transmission speed			Yes; (10/100 Mbit/s)
Functionality			
• MPI			No
• PROFINET CBA			Yes
• PROFINET IO controller			Yes
• PROFINET IO device			No
Open IE communication			
• Number of connections, max.			8
PROFINET CBA (at 50 % communication load)			
• Acyclic transmission			Yes
• Cyclic transmission			Yes
CPU/programming			
Programming language			
• STEP 7	Yes; V 5.2 SP1 or higher	Yes; V 5.3 or higher + HW update	Yes; 5.3 or higher, Service Pack 3 with HSP
• LAD	Yes	Yes	Yes
• FUP	Yes	Yes	Yes
• AWL	Yes	Yes	Yes
• SCL	Yes	Yes	Yes
• CFC	Yes	Yes	Yes
• GRAPH	Yes	Yes	Yes
• HiGraph	Yes	Yes	Yes

SIMATIC S7-300

Central processing units

Standard CPUs

4

Technical specifications (continued)

	6ES7 317-2AJ10-0AB0	6ES7 317-2EK13-0AB0	6ES7 318-3EL00-0AB0
Software libraries			
Operational stocks	See Operation List	See Operation List	See Operation List
Nesting levels	8	8	8
User program protection/password protection	Yes	Yes	Yes
System functions (SFC)	See Operation List	See Operation List	See Operation List
System function blocks (SFB)	See Operation List	See Operation List	See Operation List
Dimensions and weight			
Width	80 mm	80 mm	120 mm
Height	125 mm	125 mm	125 mm
Depth	130 mm	130 mm	130 mm
Weights			
Weight, approx.	460 g	460 g	1,250 g

Ordering data	Order No.	Order No.
CPU 312 Main memory 32 KB, power supply 24 V DC, MPI; MMC required	A) 6ES7 312-1AE13-0AB0	Micro Memory Card 64 KB 6ES7 953-8LF11-0AA0 128 KB 6ES7 953-8LG11-0AA0 512 KB 6ES7 953-8LJ11-0AA0 2 MB 6ES7 953-8LL11-0AA0 4 MB 6ES7 953-8LM11-0AA0 8 MB 6ES7 953-8LP11-0AA0
CPU 314 Main memory 96 KB, power supply 24 V DC, MPI; MMC required	A) 6ES7 314-1AG13-0AB0	MPI cable 6ES7 901-0BF00-0AA0 For connecting SIMATIC S7 and the PG through MPI; 5 m in length
CPU 315-2 DP Main memory 128 KB, power supply 24 V DC, MPI/PROFIBUS DP master/slave interface, MMC required	6ES7 315-2AG10-0AB0	Slot number plates 6ES7 912-0AA00-0AA0
CPU 315-2 PN/DP Main memory 256 KB, power supply 24 V DC, combined MPI/PROFIBUS DP master/slave interface, Ethernet/PROFINET interface; MMC required	A) 6ES7 315-2EH13-0AB0	S7-300 manual Design, CPU data, module data, instruction list German 6ES7 398-8FA10-8AA0 English 6ES7 398-8FA10-8BA0 French 6ES7 398-8FA10-8CA0 Spanish 6ES7 398-8FA10-8DA0 Italian 6ES7 398-8FA10-8EA0
CPU 317-2 DP Main memory 512 KB, power supply 24 V DC, MPI/PROFIBUS DP master/slave interface, MMC required	6ES7 317-2AJ10-0AB0	SIMATIC Manual Collection D) 6ES7 998-8XC01-8YE0 Electronic manuals on DVD, multilingual: S7-200, S7-300, C7, S7-400, SIMATIC DP (Distributed I/O), SIMATIC PC, SIMATIC PG (Programming device), STEP 7, Engineering Tools, Runtime Software, SIMATIC PCS 7, SIMATIC HMI (Human Machine Interface), SIMATIC NET (Industrial Communication), SIMATIC Machine Vision, SIMATIC Sensors
CPU 317-2 PN/DP Main memory 1 MB, power supply 24 V DC, combined MPI/PROFIBUS DP master/slave interface, Ethernet/PROFINET interface; MMC required	A) 6ES7 317-2EK13-0AB0	SIMATIC Manual Collection update service for 1 year D) 6ES7 998-8XC01-8YE2 Current "Manual Collection" DVD and the three subsequent updates
CPU 318-3 PN/DP Main memory 1.4 MB, power supply 24 V DC, combined MPI/PROFIBUS DP master/slave interface, PROFIBUS DP master/slave interface, Ethernet/PROFINET interface; MMC required	A) 6ES7 318-3EL00-0AB0	

A) Subject to export regulations: AL: N and ECCN: EAR99H

D) Subject to export regulations: AL: N and ECCN: 5D992B1

SIMATIC S7-300

Central processing units

Standard CPUs

Ordering data (continued)

Ordering data (continued)	Order No.
Power supply connector 10 units, spare part	6ES7 391-1AA00-0AA0
Labeling strips 10 units, spare part	6ES7 392-2XX00-0AA0
Label cover 10 units, spare part	6ES7 392-2XY00-0AA0
S7 SmartLabel Software for automatic labeling of modules based on data of the STEP 7 project	2XV9 450-1SL01-0YX0
Labeling sheets for machine inscription For 16-channel signal modules, DIN A4, for printing with laser printer; 10 units petrol light-beige yellow red For 32-channel signal modules, DIN A4, for printing with laser printer; 10 units petrol light-beige yellow red	6ES7 392-2AX00-0AA0 6ES7 392-2BX00-0AA0 6ES7 392-2CX00-0AA0 6ES7 392-2DX00-0AA0 6ES7 392-2AX10-0AA0 6ES7 392-2BX10-0AA0 6ES7 392-2CX10-0AA0 6ES7 392-2DX10-0AA0
Manual "Communication for SIMATIC S7-300/-400" German English French Spanish Italian	6ES7 398-8EA00-8AA0 6ES7 398-8EA00-8BA0 6ES7 398-8EA00-8CA0 6ES7 398-8EA00-8DA0 6ES7 398-8EA00-8EA0
SIMATIC S7 demo case With mounting components for mounting S7-200 and S7-300	6ES7 910-3AA00-0XA0
PROFIBUS bus components	
PROFIBUS DP bus connector RS 485 <ul style="list-style-type: none">With 90° cable outlet, max. transmission rate 12 Mbit/s - without PG interface - with PG interfaceWith 90° cable outlet for FastConnect connection system, max. transmission rate 12 Mbit/s - without PG interface - with PG interfaceWith axial cable outlet for SIMATIC OP, for connecting to PPI, MPI, PROFIBUS	6ES7 972-0BA12-0XA0 6ES7 972-0BB12-0XA0 6ES7 972-0BA50-0XA0 6ES7 972-0BB50-0XA0 6GK1 500-0EA02

Ordering data (continued)	Order No.
PROFIBUS Fast Connect bus cable Standard type with special design for quick mounting, 2-core, shielded, sold by the meter, max. delivery unit 1000 m, minimum ordering quantity 20 m	6XV1 830-0EH10
RS 485 repeater for PROFIBUS Data transmission rate up to 12 Mbit/s; 24 V DC; IP20 housing	6ES7 972-0AA01-0XA0
PROFIBUS bus components For establishing MPI/PROFIBUS communication	see Catalogs IK PI, CA 01
Industrial Ethernet bus components	
IE FC TP Standard Cable GP 2x2 4-core, shielded TP installation cable for connection to IE FC Outlet RJ45/ IE FC RJ45 Plug; PROFINET-compatible; with UL approval; Sold by the meter	6XV1 840-2AH10
FO Standard Cable GP (50/125) Standard cable, segmentable, UL approval, sold by the meter	6XV1 873-2A
Industrial Ethernet Switch SCALANCE X204-2 Industrial Ethernet switches with integral SNMP access, Web diagnostics, copper cable diagnosis and PROFINET diagnosis for configuring line, star and ring topologies; four 10/100 Mbit/s RJ45 ports and two fiber-optic ports	6GK5 204-2BB00-2AA3
IE FC RJ45 Plug 180 RJ45 plug connector for Industrial Ethernet with a rugged metal housing and integrated insulation displacement contacts for connecting Industrial Ethernet FC installation cables; with 180° cable outlet 1 unit 10 units 50 units	6GK1 901-1BB10-2AA0 6GK1 901-1BB10-2AB0 6GK1 901-1BB10-2AE0

SIMATIC S7-300

Central processing units

Technology CPUs

Overview CPU 315T-2 DP



- SIMATIC CPU with integrated technology/motion control functionality
- With the full functionality of the standard CPU 315-2 DP
- For multi-sector automation tasks in the construction of series machines, special machines and plants
- Ideal for synchronized motional sequences such a coupling to a virtual/real master, electronic gearbox, cam disc or print-mark correction.
- Used as a central controller on production lines with central and distributed I/O
- With integrated I/O for fast technological functions (e.g. cam switching, reference point detection)
- PROFIBUS DP (DRIVE) interface for the isochronous connection of drive components.
- A common S7 application program for control and motion control tasks (no additional programming language for motion control required)
- Optional "S7 Technology" package required

Micro Memory Card required for operation of CPU.

Overview CPU 317T-2 DP



- SIMATIC CPU with integrated technology/motion control functionality
- With the full functionality of the standard CPU 317-2 DP
- For multi-sector automation tasks in the construction of series machines, special machines and plants
- Ideal for synchronized motional sequences such a coupling to a virtual/real master, electronic gearbox, cam disc or print-mark correction.
- Used as a central controller on production lines with central and distributed I/O
- Distributed intelligence in Component Based Automation (CBA) on PROFIBUS DP
- With integrated I/O for fast technological functions (e.g. cam switching, reference point detection)
- PROFIBUS DP (DRIVE) interface for the isochronous connection of drive components.
- A common S7 application program for control and motion control tasks (no additional programming language for motion control required)
- Optional "S7 Technology" package required

Micro Memory Card required for operation of CPU.

Technical specifications

	6ES7 315-6TG10-0A00	6ES7 317-6TJ10-0A00
Product status		
associated programming package	STEP 7 V 5.3 or higher + SP1 and option package S7-Technology V2.0	STEP 7 V5.2 or higher + SP 1 + HF 1 and option package S7-Technology
Supply voltages		
Rated value		
• DC 24 V	Yes	Yes
• permissible range, lower limit (DC)	20.4 V	20.4 V
• permissible range, upper limit (DC)	28.8 V	28.8 V
Voltages and currents		
external protection for supply cables (recommendation)	min. 2 A	min. 2 A

	6ES7 315-6TG10-0A00	6ES7 317-6TJ10-0A00
Current consumption		
Inrush current, max.	2,5 A	2,5 A
I ² t	1 A ² s	1 A ² s
Current consumption (in no-load operation), typ.	200 mA	200 mA
Power loss, typ.	6 W	6 W
Memory		
Memory		
• RAM		
- integrated	128 KByte	512 KByte
- expandable	No	No
• Load memory		
- pluggable (MMC)	Yes	Yes; min. 4 MB required
- pluggable (MMC), max.	8 MByte	8 MByte

SIMATIC S7-300

Central processing units

Technology CPUs

Technical specifications (continued)

	6ES7 315-6TG10-0AB0	6ES7 317-6TJ10-0AB0
Backup		
• present	Yes; guaranteed by MMC (maintenance-free)	Yes; guaranteed by MMC (maintenance-free)
CPU/blocks		
DB		
• Number, max.	1,023; DB 0 reserved	2,047; DB 0 reserved
• Size, max.	16 KByte	64 KByte
FB		
• Number, max.	2,048; See Operation List	2,048; See Operation List
• Size, max.	16 KByte	64 KByte
FC		
• Number, max.	2,048; See Operation List	2,048; See Operation List
• Size, max.	16 KByte	64 KByte
OB		
• Number, max.	See Operation List	
• Size, max.	16 KByte	64 KByte
Nesting depth		
• per priority class	8	16
• additional within an error OB	4	4
CPU/processing times		
for bit operations, min.	0.1 µs	0.05 µs
for word operations, min.	0.2 µs	0.2 µs
for fixed point arithmetic, min.	2 µs	0.2 µs
for floating point arithmetic, min.	3 µs	1 µs
Times/counters and their remanence		
S7 counter		
• Number	256	512
• of which remanent without battery - adjustable	Yes	Yes
• Counting range - adjustable - lower limit - upper limit	Yes 0 999	Yes 0 999
IEC counter		
• present	Yes	Yes
• Type	SFB	SFB
S7 times		
• Number	256	512
• Remanence - adjustable - preset	Yes No retentivity	Yes No retentivity

	6ES7 315-6TG10-0AB0	6ES7 317-6TJ10-0AB0
• Time range - lower limit - upper limit	10 ms 9,990 s	10 ms 9,990 s
IEC timer		
• present	Yes	Yes
• Type	SFB	SFB
Data areas and their remanence		
Flag		
• Number, max.	2,048 Byte	4,096 Byte
• Remanence available	Yes; MB 0 to MB 2047	Yes; MB 0 to MB 4095
• Number of clock memories	8; 1 memory byte	8; 1 memory byte
Data blocks		
• Number, max.	1,023; DB 0 reserved	2,047; DB 0 reserved
• Size, max.	16 KByte	64 KByte
• Remanence adjustable	Yes	Yes
Local data		
• per priority class, max.	1,024 Byte	1,024 Byte
Address area		
I/O address area		
• Inputs	2 KByte	8 KByte
• Outputs	2 KByte	8 KByte
• of which, distributed - Inputs - Outputs	2 KByte 2 KByte	8 KByte 8 KByte
Process image		
• Inputs	128 Byte	256 Byte
• Outputs	128 Byte	256 Byte
Digital channels		
• Inputs	16,384	65,636
• Outputs	16,384	65,636
• Inputs, of which central	256	256
• Outputs, of which central	256	256
Analog channels		
• Inputs	1,024	4,096
• Outputs	1,024	4,096
• Inputs, of which central	64	64
• Outputs, of which central	64	64
Hardware config.		
Racks, max.	1	1
Modules per rack, max.	8	8

www.DataSheet4U.com
Technical specifications (continued)

	6ES7 315-6TG10-0AB0	6ES7 317-6TJ10-0AB0
Number of DP masters		
• integrated	2; 1 DP and 1 DP (drive)	2
• via CP	2; for DP	2
Number of operable FMs and CPs (recommended)		
• FM	8	8
• CP, point-to-point	8	8
• CP, LAN	10	10
Time		
Clock		
• Hardware clock (real-time clock)	Yes	Yes
• Battery backed and synchronized	Yes	Yes
• Deviation per day, max.	10 s	10 s
Operating hours counter		
• Number	1	4
• Number/Number range	0	0 bis 3
• Range of values	0 to 2 ³¹ hours (when using SFC101)	0 to 2 ³¹ hours (when using SFC101)
• Granularity	1 hour	1 hour
• remanent	Yes; must be restarted at each warm restart	Yes; must be restarted at each warm restart
Clock synchronization		
• supports	Yes	Yes
• to MPI, Master	Yes	Yes
• to MPI, Slave	Yes	Yes
• in AS, Master	Yes	Yes
• in AS, Slave	Yes	Yes
S7 message functions		
Number of login stations for message functions, max.	16; depending on the configured connections for PG/OP and S7 basic communication	32; depending on the configured connections for PG/OP and S7 basic communication
Process diagnostic messages	Yes	Yes
Simultaneously active Alarm-S blocks, max.	40	60
Test commissioning functions		
Status/control		
• Status/control variable	Yes	Yes
• Variables	Inputs, outputs, memory bits, DB, times, counters	Inputs, outputs, memory bits, DB, times, counters

	6ES7 315-6TG10-0AB0	6ES7 317-6TJ10-0AB0
Monitoring functions		
• Number of variables, max.	30	30
• of which status variable, max.	30	30
• of which control variable, max.	14	14
Forcing		
• Forcing	Yes	Yes
• Force, variables	Inputs, outputs	Inputs, outputs
• Forcing, number of variables, max.	10	10
Status block	Yes	Yes
Single step	Yes	Yes
Number of breakpoints	2	2
Diagnostic buffer		
• present	Yes	Yes
• Number of entries, max.	100	100
• adjustable	No	No
Communication functions		
PG/OP communication	Yes	Yes
Routing	Yes	Yes
Global data communication		
• supported	Yes	Yes
• Size of GD packets, max.	22 Byte	22 Byte
S7 basic communication		
• supported	Yes	Yes
S7 communication		
• supported	Yes	Yes
S5-compatible communication		
• supported	Yes; via CP and loadable FC	Yes; via CP and loadable FC
Number of connections		
• overall	16	32
• usable for PG communication	15	31
• usable for OP communication	15	31
• usable for S7 basic communication	12	30
1st interface		
Type of interface	Integral RS 485 interface	Integral RS 485 interface
Physics	RS 485	RS 485
isolated	Yes	Yes

SIMATIC S7-300

Central processing units

Technology CPUs

Technical specifications (continued)

	6ES7 315-6TG10-0AB0	6ES7 317-6TJ10-0AB0
Power supply to interface (15 to 30 V DC), max.	200 mA	200 mA
Functionality		
• MPI	Yes	Yes
• DP master	Yes	Yes
• DP slave	Yes	Yes
• Point-to-point coupling	No	No
MPI		
• Services		
- PG/OP communication	Yes	Yes
- Routing	Yes	Yes
- Global data communication	Yes	Yes
- S7 basic communication	Yes	Yes
- S7 communication	Yes	Yes
- S7 communication, as client	Yes; via CP and loadable FB	Yes; via CP and loadable FB
- S7 communication, as server	Yes	Yes
• Transmission speeds, max.	12 Mbit/s	12 Mbit/s
DP-Master		
• Services		
- PG/OP communication	Yes	Yes
- Routing	Yes	Yes
- Global data communication	No	No
- S7 basic communication	No	No
- S7 communication	No	No
- equidistance support	Yes	Yes
- SYNC/FREEZE	Yes	Yes
- DPV1	Yes	Yes
• Transmission speeds, max.	12 Mbit/s	12 Mbit/s
• Number of DP slaves, max.	124	124
• Address area		
- Inputs, max.	244 KByte; KB --> 244 bytes per DP slave	244 KByte
- Outputs, max.	244 KByte; KB --> 244 bytes per DP slave	244 KByte

	6ES7 315-6TG10-0AB0	6ES7 317-6TJ10-0AB0
DP slave		
• Services		
- Routing	Yes	Yes
- Global data communication	No	No
- S7 basic communication	No	No
- S7 communication	No	No
- direct data exchange (cross traffic)	Yes	Yes
- DPV1	No	No
• Transmission speeds, max.	12 Mbit/s	12 Mbit/s
• Transfer memory		
- Inputs	244 Byte	244 Byte
- Outputs	244 Byte	244 Byte
• Address area, max.	32	32
• Useful data per address area, max.	32 Byte	32 Byte
2nd interface		
Type of interface	Integral RS 485 interface	Integral RS 485 interface
Physics	RS 485	RS 485
isolated	Yes	Yes
Power supply to interface (15 to 30 V DC), max.	200 mA	200 mA
Functionality		
• MPI	No	No
• DP master	Yes; DP(DRIVE)-Master	Yes; DP(DRIVE)-Master
• DP slave	No	No
• Point-to-point coupling	No	No
DP master		
• Services		
- PG/OP communication	No	No
- Routing	No	No
- Global data communication	No	No
- S7 basic communication	No	No
- S7 communication	No	No
- equidistance support	Yes	Yes
- SYNC/FREEZE	No	No
- Activation/deactivation of DP slaves	No	No
- DPV1	No	No

www.DataSheet4U.com
Technical specifications (continued)

	6ES7 315-6TG10-0AB0	6ES7 317-6TJ10-0AB0
DP-Master (continued)		
• Transmission speeds, max.	12 Mbit/s	12 Mbit/s
• Number of DP slaves, max.	32	32
• Address area		
- Inputs, max.	244 KByte; KB --> 244 bytes per DP slave	244 KByte
- Outputs, max.	244 KByte; KB --> 244 bytes per DP slave	244 KByte
CPU/programming		
Configuration software		
• STEP 7	Yes	Yes
Programming language		
• STEP 7	Yes; V 5.2 SP 1 or higher and S7-Technology option package	Yes; V 5.2 SP 1 or higher and S7-Technology option package
• LAD	Yes	Yes
• FUP	Yes	Yes
• AWL	Yes	Yes
• SCL	Yes	Yes
• CFC	Yes	Yes
• GRAPH	Yes	Yes
• HiGraph	Yes	Yes
Software libraries		
Operational stocks	See Operation List	See Operation List
Nesting levels	8	8
User program protection/password protection	Yes	Yes
System functions (SFC)	See Operation List	See Operation List
System function blocks (SFB)	See Operation List	See Operation List
Digital inputs		
Number of digital inputs	4	4
Functions	technological functions, e.g. reference point recording (BERO), digital inputs can also be used (with restrictions) in STEP 7 user program.	technological functions, e.g. reference point recording (BERO), digital inputs can also be used (with restrictions) in STEP 7 user program.
Number of simultaneously controllable inputs		
• Number of simultaneously controllable inputs, up to 40 °C	4	4
• Number of simultaneously controllable inputs, up to 60 °C	4	4

	6ES7 315-6TG10-0AB0	6ES7 317-6TJ10-0AB0
Cable length		
• Cable length, shielded, max.	1,000 m	1,000 m
• Cable length unshielded, max.	600 m	600 m
• Standard-DI		
Input characteristic curve to IEC 1131, Typ 1	Yes	Yes
Input voltage		
• Rated value, DC	24 V	24 V
• for signal "0"	-3 to 5 V	-3 to 5 V
• for signal "1"	15 to 30 V	15 to 30 V
Input current		
• for signal "1", typ.	7 mA	7 mA
Input delay (for rated value of input voltage)		
• for counter/technological functions		
- at "0" to "1", max.	10 µs; typically	10 µs; typically
- at "1" to "0", max.	10 µs; typically	10 µs; typically
Digital outputs		
Number of digital outputs	8	8
Functions	for technological functions, e.g. fast cam switching signals	for technological functions, e.g. fast cam switching signals
Cable length, shielded, max.	1,000 m	1,000 m
Cable length unshielded, max.	600 m	600 m
Short-circuit protection of the output	Yes	Yes
• Response threshold, typ.	1.0 A	1.0 A
Limitation of inductive shutdown voltage to	2L+ (-48 V)	2L+ (-48 V)
Lamp load, max.	5 W	5 W
Controlling a digital input	No	No
Output voltage		
• for signal "0" (DC), max.	3 V	3 V
• for signal "1", min.	2L+ (-2.5 V)	2L+ (-2.5 V)

SIMATIC S7-300

Central processing units

Technology CPUs

Technical specifications (continued)

	6ES7 315-6TG10-0AB0	6ES7 317-6TJ10-0AB0		6ES7 315-6TG10-0AB0	6ES7 317-6TJ10-0AB0
Output current			Aggregate current of the outputs (per group)		
• for signal "1" rated value	0.5 A	0.5 A	• horizontal installation		
• for signal "1" permissible range for 0 to 60 °C, min.	5 mA	5 mA	- up to 40 °C, max.	4 A	4 A
• for signal "1" permissible range for 0 to 60 °C, max.	0.6 A	0.6 A	- up to 60 °C, max.	3 A	3 mA
• for signal "0" residual current, max.	0.3 mA	0.3 mA	• all other mounting positions		
			- up to 40 °C, max.	3 A	3 mA
Parallel switching of 2 outputs			Load impedance range		
• for increased power	No	No	• lower limit	48 Ω	48 Ω
• for redundant control of a load	No	No	• upper limit	4 kΩ	4 kΩ
Switching frequency			Encoder		
• with resistive load, max.	100 Hz	100 Hz	Connectable encoders		
• with inductive load, max.	0.2 Hz; to IEC 947-5-1, DC13	0.2 Hz; to IEC 947-5-1, DC13	• 2-wire BEROS	No	No
• on lamp load, max.	100 Hz	100 Hz	Isolation		
			Isolation, digital outputs		
			• between the channels and the backplane bus	Yes	Yes
			Galvanic isolation, digital inputs		
			• between the channels and the backplane bus	Yes	Yes
			Dimensions and weight		
			Width	160 mm	160 mm
			Height	125 mm	125 mm
			Depth	130 mm	130 mm
			Weights		
			Weight, approx.	750 g	750 g

SIMATIC S7-300

Central processing units

Technology CPUs

4

Ordering data	Order No.	Order No.
CPU 315T-2 DP Main memory 128 KB, power supply 24 V DC, MPI, PROFIBUS DP master/slave interface, PROFIBUS DP(DRIVE) interface; with Technology/Motion Control functions; MMC required	A) 6ES7 315-6TG10-0AB0	SIMATIC Manual Collection Electronic manuals on DVD, multilingual: S7-200, S7-300, C7, S7-400, SIMATIC DP (Distributed I/O), SIMATIC PC, SIMATIC PG (Programming device), STEP 7, Engineering Tools, Runtime Software, SIMATIC PCS 7, SIMATIC HMI (Human Machine Interface), SIMATIC NET (Industrial Communication), SIMATIC Machine Vision, SIMATIC Sensors
CPU 317T-2 DP Main memory 512 KB, power supply 24 V DC, MPI, PROFIBUS DP master/slave interface, PROFIBUS DP(DRIVE) interface; with Technology/Motion Control functions; MMC required	6ES7 317-6TJ10-0AB0	SIMATIC Manual Collection update service for 1 year Current "Manual Collection" DVD and the three subsequent updates
S7 Technology V3.0 Task: Option package for configuring and programming technology tasks with SIMATIC S7 CPU 31xT-2 DP Requirement: STEP 7 V5.3 SP3 or higher Delivery package: on CD; incl. documentation for CPU 31xT-2 DP (included on CD)	6ES7 864-1CC30-0YX0	Power supply connector 10 units, spare part
Micro Memory Card 4 MB 8 MB	6ES7 953-8LM11-0AA0 6ES7 953-8LP11-0AA0	Labeling strips 10 units, spare part
MPI cable For connecting SIMATIC S7 and the PG through MPI; 5 m in length	6ES7 901-0BF00-0AA0	Label cover 10 units, spare part
Front connector (1 unit) 40-pin, with screw contacts • 1 unit • 100 units 40-pin, with cage clamp contacts • 1 unit • 100 units	6ES7 392-1AM00-0AA0 6ES7 392-1AM00-1AB0 6ES7 392-1BM01-0AA0 6ES7 392-1BM01-1AB0	S7 SmartLabel Software for automatic labeling of modules based on data of the STEP 7 project
Slot number plates	6ES7 912-0AA00-0AA0	Labeling sheets for machine inscription For 16-channel signal modules, DIN A4, for printing with laser printer; 10 units petrol light-beige yellow red For 32-channel signal modules, DIN A4, for printing with laser printer; 10 units petrol light-beige yellow red
S7-300 manual Design, CPU data, module data, instruction list German English French Spanish Italian	6ES7 398-8FA10-8AA0 6ES7 398-8FA10-8BA0 6ES7 398-8FA10-8CA0 6ES7 398-8FA10-8DA0 6ES7 398-8FA10-8EA0	Manual "Communication for SIMATIC S7-300/-400" German English French Spanish Italian

A) Subject to export regulations: AL: N and ECCN: EAR99H

D) Subject to export regulations: AL: N and ECCN: 5D992B1

SIMATIC S7-300

Central processing units

Technology CPUs

Ordering data (continued)

PROFIBUS DP bus connector RS 485

- With 90° cable outlet, max. transmission rate 12 Mbit/s
 - without PG interface
 - with PG interface
- With 90° cable outlet for FastConnect connection system, max. transmission rate 12 Mbit/s
 - without PG interface
 - with PG interface
- With axial cable outlet for SIMATIC OP, for connecting to PPI, MPI, PROFIBUS

6ES7 972-0BA12-0XA0

6ES7 972-0BB12-0XA0

6ES7 972-0BA50-0XA0

6ES7 972-0BB50-0XA0

6GK1 500-0EA02

PROFIBUS Fast Connect bus cable

Standard type with special design for quick mounting, 2-core, shielded, sold by the meter, max. delivery unit 1000 m, minimum ordering quantity 20 m

RS 485 repeater for PROFIBUS

Data transfer rate up to 12 Mbit/s; 24 V DC; IP 20 housing

PROFIBUS bus components

For establishing MPI/PROFIBUS communication

Order No.

6XV1 830-0EH10

6ES7 972-0AA01-0XA0

see Catalogs IK PI, CA 01

Overview CPU 315F-2 DP



- For design of a fail-safe automation system for plants with increased safety requirements
- Based on the SIMATIC CPU 315-2 DP
- Complies with safety requirements up to SIL 3 to IEC 61508 and up to Cat. 4 according to EN 954-1
- Distributed fail-safe I/O modules can be connected through the integral PROFIBUS DP interface (PROFIsafe).
- Fail-safe I/O modules of the ET 200M range can also be centrally connected
- Central and distributed use of standard modules for non-safety-relevant applications

Micro Memory Card required for operation of CPU.

Overview CPU 315F-2 PN/DP



- For design of a fail-safe automation system for plants with increased safety requirements
- Complies with safety requirements up to SIL 3 to IEC 61508 and up to Cat. 4 according to EN 954-1
- Fail-safe I/O modules in distributed stations can be connected through the integrated PROFINET interface (PROFIsafe) and/or through the integrated PROFIBUS DP interface (PROFIsafe);
- Fail-safe I/O modules of the ET 200M range can also be centrally connected
- Central and distributed use of standard modules for non-safety-relevant applications
- Component based Automation (CBA) on PROFINET
- PROFINET proxy for intelligent devices on PROFIBUS DP in Component Based Automation (CBA)

Micro Memory Card required for operation of CPU.

SIMATIC S7-300

Central processing units

Fail-safe CPUs

Overview CPU 317F-2 DP



- The fail-safe CPU with a large program memory and quantity framework for demanding applications
- For design of a fail-safe automation system for plants with increased safety requirements
- Complies with safety requirements up to SIL 3 to IEC 61508 and up to Cat. 4 according to EN 954-1
- Distributed fail-safe I/O modules can be connected through the two integral PROFIBUS DP interfaces (PROFIsafe).
- Fail-safe I/O modules of the ET 200M range can also be centrally connected
- Central and distributed use of standard modules for non safety-relevant applications

Micro Memory Card required for operation of CPU.

Overview CPU 317F-2 PN/DP



- The fail-safe CPU with a large program memory and quantity framework for demanding applications
- For design of a fail-safe automation system for plants with increased safety requirements
- Complies with safety requirements up to SIL 3 to IEC 61508 and up to Cat. 4 according to EN 954-1
- Fail-safe I/O modules in distributed stations can be connected through the integrated PROFINET interface (PROFIsafe) and/or through the integrated PROFIBUS DP interface (PROFIsafe)
- Fail-safe I/O modules of the ET 200M range can also be centrally connected
- Central and distributed use of standard modules for non safety-relevant applications
- Component Based Automation (CBA) on PROFINET
- PROFINET proxy for intelligent devices on PROFIBUS DP in Component Based Automation (CBA)

Micro Memory Card required for operation of CPU.

Technical specifications

	6ES7 315-6FF01-0AB0	6ES7 315-2FH13-0AB0	6ES7 317-6FF03-0AB0	6ES7 317-2FK13-0AB0
Product status				
associated programming package	STEP 7 V5.1 or higher + SP 6	STEP 7 V5.3 SP3 or higher + HW update, S7 Distributed Safety V5.4 or higher	STEP 7 V5.2 or higher SP1 + HW update, Distributed Safety 5.2 or higher + SP1	STEP 7 V5.3 SP3 or higher + HW update, S7 Distributed Safety V5.4 or higher
Supply voltages				
Rated value				
• DC 24 V	Yes	Yes	Yes	Yes
• permissible range, lower limit (DC)	20.4 V	20.4 V	20.4 V	20.4 V
• permissible range, upper limit (DC)	28.8 V	28.8 V	28.8 V	28.8 V
Voltages and currents				
external protection for supply cables (recommendation)	min. 2 A	min. 2 A	min. 2 A	min. 2 A
Current consumption				
Inrush current, typ.	2.5 A	2.5 A	2.5 A	2.5 A
I ² t	0,5 A ² s	1 A ² s	1 A ² s	1 A ² s
Current consumption (in no-load operation), typ.	60 mA	100 mA	100 mA	100 mA
Current consumption (rated value)		650 mA		650 mA

www.DataSheet4U.com

SIMATIC S7-300

Central processing units

Fail-safe CPUs

4

www.DataSheet4U.com
Technical specifications (continued)

	6ES7 315-6FF01-0AB0	6ES7 315-2FH13-0AB0	6ES7 317-6FF03-0AB0	6ES7 317-2FK13-0AB0
Power loss, typ.	2.5 W	3.5 W	4 W	3.5 W
Memory				
Memory				
• RAM				
- integrated	192 KByte; The number of F-instructions compared to a standard program is limited due to the F-specific overheads; depending on the type of programming, about 36 K F-instructions are possible.	256 KByte; for program and data, less the display data	1,024 KByte	1 MByte; for program and data, less the display data
- expandable	No	No	No	No
• Load memory				
- pluggable (MMC)	Yes	Yes	Yes	Yes
- pluggable (MMC), max.	8 MByte	8 MByte	8 MByte	8 MByte
- expandable FEPROM		Pluggable via MMC		
Backup				
• present	Yes; Guaranteed by MMC (maintenance-free)	Yes; Guaranteed by MMC (maintenance-free)	Yes; Guaranteed by MMC (maintenance-free)	Yes; Guaranteed by MMC (maintenance-free)
• without battery		Yes; Program and data	Yes; Program and data	Yes; Program and data
CPU/blocks				
DB				
• Number, max.	1,023; DB 0 reserved	1,023; Number band: 1 to 1023	2,047; Number band: 1 to 2047	2,047; Number band: 1 to 2047
• Size, max.	16 KByte	16 KByte	64 KByte	64 KByte
FB				
• Number, max.	2,048; See Operation List	1,024; Number band: 0 to 2047	2,048; Number band: 0 to 2047	2,048; Number band: 0 to 2047
• Size, max.	16 KByte	16 KByte	64 KByte	64 KByte
FC				
• Number, max.	2,048; See Operation List	1,024; Number band: 0 to 2047	2,048; Number band: 0 to 2047	2,048; Number band: 0 to 2047
• Size, max.	16 KByte	16 KByte	64 KByte	64 KByte
OB				
• Number, max.		See Operation List	See Operation List	See Operation List
• Size, max.	16 KByte	16 KByte	64 KByte	64 KByte
Nesting depth				
• per priority class	8	8	16	16
• additional within an error OB	4	4	4	4
CPU/processing times				
for bit operations, min.	0.1 µs	0.1 µs	0.05 µs	0.05 µs
for word operations, min.	0.2 µs	0.2 µs	0.2 µs	0.2 µs
for fixed point arithmetic, min.	2 µs	2 µs	0.2 µs	0.2 µs
for floating point arithmetic, min.	6 µs	3 µs	1 µs	1 µs
Times/counters and their remanence				
S7 counter				
• Number	256	256	512	512
• of which remanent without battery				
- adjustable	Yes	Yes	Yes	Yes
- lower limit		0		0
- upper limit		255		511

SIMATIC S7-300

Central processing units

Fail-safe CPUs

Technical specifications (continued)

	6ES7 315-6FF01-0AB0	6ES7 315-2FH13-0AB0	6ES7 317-6FF03-0AB0	6ES7 317-2FK13-0AB0
<ul style="list-style-type: none"> • Remanence <ul style="list-style-type: none"> - adjustable - lower limit - upper limit 		Yes 0 255	Yes 0 511	Yes 0 511
<ul style="list-style-type: none"> • Counting range <ul style="list-style-type: none"> - adjustable - lower limit - upper limit 	0 999	Yes 0 999	Yes 0 999	Yes 0 999
IEC counter				
<ul style="list-style-type: none"> • present • Type 	Yes SFB	Yes SFB	Yes SFB	Yes SFB
S7 times				
<ul style="list-style-type: none"> • Number • Remanence <ul style="list-style-type: none"> - adjustable - lower limit - upper limit - preset 	256 Yes no retentivity	256 Yes 0 255 no retentivity	512 Yes 0 511 no retentivity	512 Yes 0 511 no retentivity
<ul style="list-style-type: none"> • Time range <ul style="list-style-type: none"> - lower limit - upper limit 	10 ms 9,990 s	10 ms 9,990 s	10 ms 9,990 s	10 ms 9,990 s
IEC timer				
<ul style="list-style-type: none"> • present • Type 	Yes SFB	Yes SFB	Yes SFB	Yes SFB
Data areas and their remanence				
Flag				
<ul style="list-style-type: none"> • Number, max. • Remanence available • Number of clock memories 	2,048 Byte Yes; MB 0 to MB 2047 8; 1 memory byte	2,048 Byte Yes; MB 0 to MB 2047 8; 1 memory byte	4,096 Byte Yes; MB 0 to MB 4095 8; 1 memory byte	4,096 Byte Yes; MB 0 to MB 4095 8; 1 memory byte
Data blocks				
<ul style="list-style-type: none"> • Number, max. • Size, max. • Remanence adjustable • Remanence preset 	1,023; DB 0 reserved 16 KByte	1,023; from DB 1 to DB 1023 16 KByte Yes; via non-retain property on DB Yes	2,047; from DB 1 to DB 2047 64 KByte Yes; via non-retain property on DB Yes	2,047; from DB 1 to DB 2047 64 KByte Yes; via non-retain property on DB Yes
Local data				
<ul style="list-style-type: none"> • per priority class, max. 	1,024 Byte	1,024 Byte; per block max. 510	1,024 Byte	1,024 Byte
Address area				
I/O address area				
<ul style="list-style-type: none"> • Inputs • Outputs • of which, distributed <ul style="list-style-type: none"> - Inputs - Outputs 	2 KByte 2 KByte 2 KByte 2 KByte	2 KByte 2 KByte 2 KByte 2 KByte	8 KByte 8 KByte 8 KByte 8 KByte	8 KByte 8 KByte 8 KByte 8 KByte

SIMATIC S7-300

Central processing units

Fail-safe CPUs

4

www.DataSheet4U.com
Technical specifications (continued)

	6ES7 315-6FF01-0AB0	6ES7 315-2FH13-0AB0	6ES7 317-6FF03-0AB0	6ES7 317-2FK13-0AB0
Process image				
• Inputs	384 Byte	384 Byte	1,024 Byte	2,048 Byte
• Outputs	384 Byte	384 Byte	1,024 Byte	2,048 Byte
• Inputs, adjustable				2,048 Byte
• Outputs, adjustable				2,048 Byte
• Inputs, preset				1,024 Byte
• Outputs, preset				1,024 Byte
Digital channels				
• Inputs	16,384	16,384	65,536	65,536
• Outputs	16,384	16,384	65,536	65,536
• Inputs, of which central	1,024	1,024; max.	1,024	1,024
• Outputs, of which central	1,024	1,024; max.	1,024	1,024
Analog channels				
• Inputs	1,024	1,024	4,096	4,096
• Outputs	1,024	1,024	4,096	4,096
• Inputs, of which central	256	256; max.	256	256
• Outputs, of which central	256	256; max.	256	256
Hardware config.				
Central devices, max.		1	1	1
Expansion devices, max.		3	3	3
Racks, max.	4	4	4	4
Modules per rack, max.	8	8	8	8
Number of DP masters				
• integrated	1	1	2	1
• via CP	1	4	4	4
Number of operable FMs and CPs (recommended)				
• FM	8	8	8	8
• CP, point-to-point	8	8	8	8
• CP, LAN	10	10	10	10
Time				
Clock				
• Hardware clock (real-time clock)	Yes	Yes	Yes	Yes
• Battery backed and synchronized	Yes	Yes	Yes	Yes
• Deviation per day, max.	10 s	10 s	10 s	10 s
Operating hours counter				
• Number	1	1	4	4
• Number/Number range	0	0	0 to 3	0 to 3
• Range of values	0 to 2 ³¹ hours (when using SFC101)	2 to the power of 31 hours (when using the SFC 101)	0 to 2 ³¹ hours (when using SFC101)	0 to 2 ³¹ hours (when using SFC101)
• Granularity	1 hour	1 hour	1 hour	1 hour
• remanent	Yes; must be restarted at each warm restart	Yes; must be restarted at each warm restart	Yes; must be restarted at each warm restart	Yes; must be restarted at each warm restart
Clock synchronization				
• supports	Yes	Yes	Yes	Yes
• to MPI, Master	Yes	Yes	Yes	Yes
• to MPI, Slave	Yes	Yes	Yes	Yes
• in AS, Master	Yes	Yes	Yes	Yes
• in AS, Slave		Yes	Yes	Yes

SIMATIC S7-300

Central processing units

Fail-safe CPUs

Technical specifications (continued)

	6ES7 315-6FF01-0AB0	6ES7 315-2FH13-0AB0	6ES7 317-6FF03-0AB0	6ES7 317-2FK13-0AB0
S7 message functions				
Number of login stations for message functions, max.	16; depending on the configured connections for PG/OP and S7 basic communication	16; (depending on the configured connections for PG-/OP and S7 basic communication)	32; depending on the configured connections for PG/OP and S7 basic communication	32; depending on the configured connections for PG-/ OP- and S7-basic communication
Process diagnostic messages	Yes	Yes	Yes	Yes
simultaneously active Alarm-S blocks, max.	40	40	60	60
Test commissioning functions				
Status/control				
• Status/control variable	Yes	Yes	Yes	Yes
• Variables	Inputs, outputs, memory bits, DB, times, counters	Inputs, outputs, memory bits, DB, times, counters	Inputs, outputs, memory bits, DB, times, counters	Inputs, outputs, memory bits, DB, times, counters
Monitoring functions				
• Number of variables, max.	30	30	30	30
• of which status variable, max.	30	30	30	30
• of which control variable, max.	14	14	14	14
Forcing				
• Forcing	Yes	Yes	Yes	Yes
• Force, variables	Inputs, outputs	Inputs, outputs	Inputs, outputs	Inputs, outputs
• Forcing, number of variables, max.	10	10	10	10
Status block	Yes	Yes	Yes	Yes
Single step	Yes	Yes	Yes	Yes
Number of breakpoints	2	2	2	2
Diagnostic buffer				
• present	Yes	Yes	Yes	Yes
• Number of entries, max.	100	100	100	100
• adjustable	No	No	No	No
Communication functions				
PG/OP communication	Yes	Yes	Yes	Yes
Routing	Yes	Yes	Yes	Yes
Global data communication				
• supported	Yes	Yes	Yes	Yes
• Size of GD packets, max.	22 Byte	22 Byte	22 Byte	22 Byte
S7 basic communication				
• supported	Yes	Yes	Yes	Yes
S7 communication				
• supported	Yes	Yes	Yes	Yes
S5-compatible communication				
• supported	Yes; via CP and loadable FC	Yes; via CP and loadable FC	Yes; via CP and loadable FC	Yes; via CP and loadable FC
Open IE communication				
• TCP/IP		Yes; via integrated PROFINET interface and loadable FBs		Yes; via integrated PROFINET interface and loadable FBs
- Number of connections, max.		8		8
- Data length, max.		1,460 Byte		1,460 Byte

SIMATIC S7-300

Central processing units

Fail-safe CPUs

4

www.DataSheet4U.com
Technical specifications (continued)

	6ES7 315-6FF01-0AB0	6ES7 315-2FH13-0AB0	6ES7 317-6FF03-0AB0	6ES7 317-2FK13-0AB0
Number of connections				
• overall	16	16	32	32
• usable for PG communication	15	15; max.	31	31
• usable for OP communication	15	15	31	31
• usable for S7 basic communication	13	14	30	30
• usable for routing		X1 as MPI: max. 10; X1 as DP-master: max. 24; X1 as DP-slave (active): max. 14; X2 as PROFINET: max. 24	8	
PROFINET CBA (at set setpoint communication load)				
• Setpoint for the CPU communication load		50%		50%
• Number of remote interconnection partners		32		32
• Number of functions, master/slave		17		17
• Total of all master/slave connections		1.000		1,000
• Data length of all incoming connections master/slave, max.		4,000 Byte		4,000 Byte
• Data length of all outgoing connections master/slave, max.		4,000 Byte		4,000 Byte
• Number of device-internal and PROFIBUS interconnections		500		500
• Data length of device-internal und PROFIBUS interconnections, max.		4,000 Byte		4,000 Byte
• Data length per connection, max.		1,400 Byte		1,400 Byte
• Remote interconnections with acyclic transmission				
- Sampling frequency: sampling interval, min.		500 ms		500 ms
- Number of incoming interconnections		100		100
- Number of outgoing interconnections		100		100
- Data length of all incoming interconnections, max.		2,000 Byte		2,000 Byte
- Data length of all outgoing interconnections, max.		2,000 Byte		2,000 Byte
- Data length per connection, max.		1,400 Byte		1,400 Byte
• Remote interconnections with cyclic transmission				
- Transmission frequency: transmission interval, min.		10 ms		10 ms
- Number of incoming interconnections		200		200
- Number of outgoing interconnections		200		200

SIMATIC S7-300

Central processing units

Fail-safe CPUs

Technical specifications (continued)

	6ES7 315-6FF01-0AB0	6ES7 315-2FH13-0AB0	6ES7 317-6FF03-0AB0	6ES7 317-2FK13-0AB0
PROFINET CBA (at set setpoint communication load)				
<ul style="list-style-type: none"> Remote interconnections with cyclic transmission (cont.) <ul style="list-style-type: none"> Data length of all incoming interconnections, max. Data length of all outgoing interconnections, max. Data length per connection, max. 		2,000 Byte 2,000 Byte 450 Byte		2,000 Byte 2,000 Byte 450 Byte
<ul style="list-style-type: none"> HMI variables via PROFINET (acyclic) <ul style="list-style-type: none"> Number of log-in stations for HMI variables (PN OPC/iMap) HMI variable updating Number of HMI variables Data length of all HMI variables, max. 		3; 2 * PN OPC / 1 * iMap 500 ms 200 2,000 Byte		3; 2 * PN OPC / 1 * iMap 500 ms 200 2,000 Byte
<ul style="list-style-type: none"> PROFIBUS proxy functionality <ul style="list-style-type: none"> supported Number of linked PROFIBUS devices Data length per connection, max. 		Yes 16 240 Byte; Slave-dependent		Yes 16 240 Byte; Slave-dependent
PROFINET CBA (at 50 % communication load)				
<ul style="list-style-type: none"> Data length for arrays and structures (local interconnection), max. HMI variables via PROFINET (acyclic) <ul style="list-style-type: none"> Number of log-in stations for HMI variables (PN OPC/iMap) 		Slave-dependent 2 * PN OPC / 1 * iMap		Slave-dependent 2 * PN OPC / 1 * iMap
1st interface				
Type of interface	Integral RS 485 interface	Integral RS 485 interface	Integral RS 485 interface	Integral RS 485 interface
Physics	RS 485	RS 485	RS 485	RS 485
isolated	No	Yes	Yes	Yes
Power supply to interface (15 to 30 V DC), max.	200 mA	200 mA	200 mA	200 mA
Functionality				
<ul style="list-style-type: none"> MPI DP master DP slave Point-to-point coupling 	Yes No No No	Yes Yes Yes No	Yes Yes Yes No	Yes Yes Yes No
MPI				
<ul style="list-style-type: none"> Number of connections Services <ul style="list-style-type: none"> PG/OP communication Routing Global data communication S7 basic communication S7 communication S7 communication, as client S7 communication, as server 	16 Yes Yes Yes Yes Yes; via CP and loadable FB Yes	16 Yes Yes Yes Yes No Yes	32 Yes Yes Yes Yes No Yes	16 Yes Yes Yes Yes No Yes

www.DataSheet4U.com
Technical specifications (continued)

	6ES7 315-6FF01-0AB0	6ES7 315-2FH13-0AB0	6ES7 317-6FF03-0AB0	6ES7 317-2FK13-0AB0
MPI (continued)				
• Transmission speeds, max.	187,5 kBit/s	12 Mbit/s	12 Mbit/s	12 Mbit/s
DP master				
• Services				
- PG/OP communication		Yes	Yes	Yes
- Routing		Yes	Yes	Yes
- Global data communication		No	No	No
- S7 basic communication		Yes	Yes	Yes
- S7 communication		Yes	Yes	Yes
- S7 communication, as client		No	No	No
- S7 communication, as server		Yes	Yes	Yes
- Equidistance support		Yes	Yes	Yes
- SYNC/FREEZE		Yes	Yes	Yes
- DPV1		Yes	Yes	Yes
• Transmission speeds, max.		12 Mbit/s	12 Mbit/s	12 Mbit/s
• Number of DP slaves, max.		124	124	124
• Address area			244 Byte	
- Inputs, max.			244 Byte	
- Outputs, max.				
DP slave				
• Services				
- Routing		Yes; only when interface active	Yes; only when interface active	Yes; only when interface active
- Global data communication		No	No	No
- S7 basic communication		Yes	Yes	Yes
- S7 communication		Yes	Yes	Yes
- S7 communication, as client		No	No	No
- S7 communication, as server		Yes	Yes	Yes
- direct data exchange (cross traffic)		Yes	Yes	Yes
- DPV1		No	No	No
• Transmission speeds, max.		12 Mbit/s	12 Mbit/s	12 Mbit/s
• Transfer memory				
- Inputs		244 Byte	244 Byte	244 Byte
- Outputs		244 Byte	244 Byte	244 Byte
• Address area, max.		32; with max. 32 bytes each	32	32
• Useful data per address area, max.			32 Byte	32 Byte
2nd interface				
Type of interface	Integral RS 485 interface	PROFINET	Integral RS 485 interface	PROFINET
Physics	RS 485	Ethernet	RS 485	Ethernet
isolated	Yes	Yes	Yes	Yes
Power supply to interface (15 to 30 V DC), max.	200 mA	0 mA	200 mA	0 mA
automatic detection of transmission speed		Yes; (10/100 Mbit/s)		Yes; (10/100 Mbit/s)
Functionality				
• MPI	No	No	No	No
• DP master	Yes	No	Yes	No

SIMATIC S7-300

Central processing units

Fail-safe CPUs

Technical specifications (continued)

	6ES7 315-6FF01-0AB0	6ES7 315-2FH13-0AB0	6ES7 317-6FF03-0AB0	6ES7 317-2FK13-0AB0
Functionality (continued)				
• DP slave	Yes	No	Yes	No
• Point-to-point coupling	No	No	No	No
• PROFINET CBA		Yes		Yes
• PROFINET IO controller		Yes		Yes; Firmware Status V2.3 or higher
DP master				
• Number of connections, max.	16		32	
• Services				
- PG/OP communication	Yes		Yes	
- Routing	Yes		Yes	
- Global data communication	No		No	
- S7 basic communication	No		Yes	
- S7 communication	No		Yes	
- S7 communication, as client			No	
- S7 communication, as server			Yes	
- equidistance support	Yes		Yes	
- SYNC/FREEZE	Yes		Yes	
- DPV1	Yes		Yes	
• Transmission speeds, max.	12 Mbit/s		12 Mbit/s	
• Number of DP slaves, max.	125		124	
• Address area				
- Inputs, max.	244 KByte		244 Byte	
- Outputs, max.	244 KByte		244 Byte	
DP slave				
• Number of connections	16		32	
• Services				
- PG/OP communication	Yes		Yes	
- Routing	Yes; when interface active		Yes; when interface active	
- Global data communication	No		No	
- S7 basic communication	No		Yes	
- S7 communication, as client	No		No	
- S7 communication, as server	No		Yes	
- direct data exchange (cross traffic)	Yes		Yes	
- DPV1	No		No	
• GSD file	http://www.ad.siemens.de/csi_e/gsd		http://www.ad.siemens.de/support in Product Support area	
• Transmission speeds, max.	12 Mbit/s		12 Mbit/s	
• automatic baud rate search			Yes; only with passive interface	
• Transfer memory				
- Inputs	244 Byte		244 Byte	
- Outputs	244 Byte		244 Byte	
• Address area, max.	32		32	
• Useful data per address area, max.	32 Byte		32 Byte	
PROFINET CBA				
• Acyclic transmission		Yes		Yes
• Cyclic transmission		Yes		Yes

SIMATIC S7-300

Central processing units

Fail-safe CPUs

4

Technical specifications (continued)

	6ES7 315-6FF01-0AB0	6ES7 315-2FH13-0AB0	6ES7 317-6FF03-0AB0	6ES7 317-2FK13-0AB0
PROFINET IO controller				
<ul style="list-style-type: none"> Services <ul style="list-style-type: none"> - PG/OP communication - Routing - S7 communication - open IE communication 		Yes Yes Yes; with loadable FBs, max. configurable connections: 14, max. number of instances: 32 Yes; via TCP/IP		Yes Yes Yes; with loadable FBs, max. configurable connections: 16, max. number of instances: 32 Yes; via TCP/IP
<ul style="list-style-type: none"> Transmission speed, max. Number of connectable IO-devices, max. Update time 		100 Mbit/s 128 1 to 512 ms (minimum value depends on communication share set for PROFINET IO, on the number of IO devices and on the number of configured useful data items)		100 Mbit/s 128 1 to 512 ms (minimum value depends on communication share set for PROFINET IO, on the number of IO devices and on the number of configured useful data items)
<ul style="list-style-type: none"> Address area <ul style="list-style-type: none"> - Inputs, max. - Outputs, max. Useful data consistency, max. 		2 KByte 2 KByte 256 Byte		8 KByte 8 KByte 256 Byte
CPU/programming				
Programming language				
<ul style="list-style-type: none"> STEP 7 LAD FUP AWL SCL CFC GRAPH HiGraph 	Yes; V5.1 SP6 or higher Yes Yes Yes Yes Yes Yes Yes	Yes; V 5.3 SP3 or higher + hardware update Yes Yes Yes Yes Yes Yes Yes	Yes; V 5.2 SP1 or higher Yes Yes Yes Yes Yes Yes Yes	Yes; V 5.3 SP3 or higher + HW update Yes Yes Yes Yes Yes Yes Yes
Software libraries				
Operational stocks	See Operation List	See Operation List	See Operation List	See Operation List
Nesting levels	8	8	8	8
User program protection/password protection	Yes	Yes	Yes	Yes
System functions (SFC)	See Operation List	See Operation List	See Operation List	See Operation List
System function blocks (SFB)	See Operation List	See Operation List	See Operation List	See Operation List
Dimensions and weight				
Width	40 mm	80 mm	80 mm	80 mm
Height	125 mm	125 mm	125 mm	125 mm
Depth	130 mm	130 mm	130 mm	130 mm
Weights				
Weight, approx.	290 g	460 g	460 g	460 g

SIMATIC S7-300

Central processing units

Fail-safe CPUs

www.DataSheet4U.com

Ordering data	Order No.	Order No.
CPU 315F-2 DP CPU for SIMATIC S7-300F; main memory 192 KB, power supply 24 V DC, MPI/PROFIBUS DP master/slave interface, incl. single location number labels, MMC required	6ES7 315-6FF01-0AB0	
CPU 315F-2 PN/DP A)	6ES7 315-2FH13-0AB0	
CPU for SIMATIC S7-300F; main memory 256 KB, power supply 24 V DC, MPI/PROFIBUS DP master/slave interface, Industrial Ethernet/PROFINET interface; incl. slot number labels, MMC required		
CPU 317F-2 DP A)	6ES7 317-6FF03-0AB0	
Main memory 1 MB, power supply 24 V DC, MPI, PROFIBUS DP master/slave interface, MMC required		
CPU 317F-2 PN/DP A)	6ES7 317-2FK13-0AB0	
Main memory 1 MB, power supply 24 V DC, MPI/PROFIBUS DP master/slave interface, Industrial Ethernet/PROFINET interface; MMC required		
Distributed Safety V5.4 programming tool Task: Software for configuring fail-safe user programs for SIMATIC S7-300F, S7-400F, ET 200S Requirement: STEP 7 V5.3 SP3 and higher Floating license Software Update Service	6ES7 833-1FC02-0YA5 6ES7 833-1FC00-0YX2	
Distributed Safety Upgrade From V5.x to V5.4; Floating license for 1 user	6ES7 833-1FC02-0YE5	
Micro Memory Card 64 KB 128 KB 512 KB 2 MB 4 MB 8 MB	6ES7 953-8LF11-0AA0 6ES7 953-8LG11-0AA0 6ES7 953-8LJ11-0AA0 6ES7 953-8LL11-0AA0 6ES7 953-8LM11-0AA0 6ES7 953-8LP11-0AA0	
MPI cable For connecting SIMATIC S7 and the PG through MPI; 5 m in length	6ES7 901-0BF00-0AA0	
Slot number plates	6ES7 912-0AA00-0AA0	
	S7-300 manual Design, CPU data, module data, instruction list German English French Spanish Italian	6ES7 398-8FA10-8AA0 6ES7 398-8FA10-8BA0 6ES7 398-8FA10-8CA0 6ES7 398-8FA10-8DA0 6ES7 398-8FA10-8EAO
	SIMATIC Manual Collection D)	6ES7 998-8XC01-8YE0
	Electronic manuals on DVD, multilingual: S7-200, S7-300, C7, S7-400, SIMATIC DP (Distributed I/O), SIMATIC PC, SIMATIC PG (Programming device), STEP 7, Engineering Tools, Runtime Software, SIMATIC PCS 7, SIMATIC HMI (Human Machine Interface), SIMATIC NET (Indus- trial Communication), SIMATIC Machine Vision, SIMATIC Sensors	
	SIMATIC Manual Collection update service for 1 year D)	6ES7 998-8XC01-8YE2
	Current "Manual Collection" DVD and the three subsequent updates	
	Power supply connector	6ES7 391-1AA00-0AA0
	10 units, spare part	
	Labeling strips	6ES7 392-2XX00-0AA0
	10 units, spare part	
	Label cover	6ES7 392-2XY00-0AA0
	10 units, spare part	
	S7 SmartLabel	2XV9 450-1SL01-0YX0
	Software for automatic labeling of modules based on data of the STEP 7 project	
	Labeling sheets for machine inscription For 16-channel signal modules, DIN A4, for printing with laser printer; 10 units petrol light-beige yellow red For 32-channel signal modules, DIN A4, for printing with laser printer; 10 units petrol light-beige yellow red	6ES7 392-2AX00-0AA0 6ES7 392-2BX00-0AA0 6ES7 392-2CX00-0AA0 6ES7 392-2DX00-0AA0 6ES7 392-2AX10-0AA0 6ES7 392-2BX10-0AA0 6ES7 392-2CX10-0AA0 6ES7 392-2DX10-0AA0

A) Subject to export regulations: AL: N and ECCN: EAR99H

D) Subject to export regulations: AL: N and ECCN: 5D992B1

SIMATIC S7-300

Central processing units

Fail-safe CPUs

Ordering data	Order No.	Order No.
www.DataSheet4U.com Manual "Communication for SIMATIC S7-300/-400"		
German	6ES7 398-8EA00-8AA0	
English	6ES7 398-8EA00-8BA0	
French	6ES7 398-8EA00-8CA0	
Spanish	6ES7 398-8EA00-8DA0	
Italian	6ES7 398-8EA00-8EA0	
PROFIBUS bus components		
PROFIBUS DP bus connector RS 485		
<ul style="list-style-type: none"> With 90° cable outlet, max. transmission rate 12 Mbit/s <ul style="list-style-type: none"> - without PG interface - with PG interface With 90° cable outlet for FastConnect connection system, max. transmission rate 12 Mbit/s <ul style="list-style-type: none"> - without PG interface - with PG interface With axial cable outlet for SIMATIC OP, for connecting to PPI, MPI, PROFIBUS 	6ES7 972-0BA12-0XA0 6ES7 972-0BB12-0XA0 6ES7 972-0BA50-0XA0 6ES7 972-0BB50-0XA0 6GK1 500-0EA02	
PROFIBUS Fast Connect bus cable	6XV1 830-0EH10	
Standard type with special design for quick mounting, 2-core, shielded, sold by the meter, max. delivery unit 1000 m, minimum ordering quantity 20 m		
RS 485 repeater for PROFIBUS	6ES7 972-0AA01-0XA0	
Data transmission rate up to 12 Mbit/s; 24 V DC; IP20 housing		
PROFIBUS bus components	see catalogs IK PI, CA 01	
For establishing MPI/PROFIBUS communication		
		Industrial Ethernet bus components
		IE FC TP Standard Cable GP 2x2
		6XV1 840-2AH10
		4-core, shielded TP installation cable for connection to IE FC Outlet RJ45/ IE FC RJ45 Plug; PROFINET-compatible; with UL approval; Sold by the meter
		FO Standard Cable GP (50/125)
		6XV1 873-2A
		Standard cable, segmentable, UL approval, sold by the meter
		Industrial Ethernet Switch SCALANCE X204-2
		6GK5 204-2BB00-2AA3
		Industrial Ethernet switches with integral SNMP access, Web diagnostics, copper cable diagnosis and PROFINET diagnosis for configuring line, star and ring topologies; four 10/100 Mbit/s RJ45 ports and two fiber-optic ports
		IE FC RJ45 Plug 180
		RJ45 plug connector for Industrial Ethernet with a rugged metal housing and integrated insulation displacement contacts for connecting Industrial Ethernet FC installation cables; with 180° cable outlet
		1 unit 10 units 50 units
		6GK1 901-1BB10-2AA0 6GK1 901-1BB10-2AB0 6GK1 901-1BB10-2AE0

4

SIMATIC S7-300

SIPLUS central processing units

SIPLUS compact CPUs

Overview SIPLUS CPU 312C



- The compact CPU with integrated digital inputs and outputs
- For small applications with high requirements in terms of processing power
- With process-related functions

Micro memory card required to operate the CPU.

	SIPLUS CPU 312C
Order No.	6AG1 312-5BD01-2AB0
Order No. based on	6ES7 312-5BD01-0AB0
Ambient temperature range	-25 °C to +60 °C, condensation permissible
Ambient conditions	Suitable for extraordinary medial load (for example by chloric and sulphuric atmospheres).
Conformity with standard for electronic devices on rail vehicles (EN 50155, temperature T1, category 1)	Yes
Technical data	The technical data are identical with the technical data of the based on modules.

Overview SIPLUS CPU 313C



- The compact CPU with integrated digital and analog inputs and outputs
- For installations with high requirements in terms of processing power and response time.
- With process-related functions

Micro memory card required to operate the CPU.

	SIPLUS CPU 313C
Order No.	6AG1 313-5BE01-2AB0
Order No. based on	6ES7 313-5BE01-0AB0
Ambient temperature range	-25 °C to +60 °C, condensation permissible
Ambient conditions	Suitable for extraordinary medial load (for example by chloric and sulphuric atmospheres).
Conformity with standard for electronic devices on rail vehicles (EN 50155, temperature T1, category 1)	Yes
Technical data	The technical data are identical with the technical data of the based on modules.

SIMATIC S7-300

SIPLUS central processing units

SIPLUS compact CPUs

Overview SIPLUS CPU 313C-2 DP



- The compact CPU with integrated digital I/Os and PROFIBUS DP master/slave interface
- With process-related functions
- For tasks with special functions
- For the connection of standalone I/O devices

Micro memory card required to operate the CPU.

	SIPLUS CPU 313C-2 DP
Order No.	6AG1 313-6CE01-2AB0
Order No. based on	6ES7 313-6CE01-0AB0
Ambient temperature range	-25 °C to +60 °C, condensation permissible
Ambient conditions	Suitable for extraordinary medial load (for example by chloric and sulphuric atmospheres).
Conformity with standard for electronic devices on rail vehicles (EN 50155, temperature T1, category 1)	Yes
Technical data	The technical data are identical with the technical data of the based on modules.

Overview SIPLUS CPU 314C-2 DP



- The compact CPU with integrated digital and analog inputs and outputs and PROFIBUS DP master/slave interface
- With process-related functions
- For tasks with special functions
- For connection of distributed I/O

Micro memory card required to operate the CPU.

	SIPLUS CPU 314C-2 DP
Order No.	6AG1 314-6CF02-2AB0
Order No. based on	6ES7 314-6CF02-0AB0
Ambient temperature range	-25 °C to +60 °C, condensation permissible
Ambient conditions	Suitable for extraordinary medial load (for example by chloric and sulphuric atmospheres).
Conformity with standard for electronic devices on rail vehicles (EN 50155, temperature T1, category 1)	No
Technical data	The technical data are identical with the technical data of the based on modules.

Technical specifications

	6AG1 312-5BD01-2AB0	6AG1 313-5BE01-2AB0	6AG1 313-6CE01-2AB0	6AG1 314-6CF02-2AB0
Product status				
associated programming package	STEP 7 V5.2 + SP 1 or higher	STEP 7 V5.2 or higher + SP 1	STEP 7 V5.2 + SP 1 or higher (with STEP 7 5.1 + SP 3 or higher, please use predecessor-CPU)	STEP 7 V 5.2 or higher + SP 1 with HW update
Supply voltages				
Rated value				
• DC 24 V	Yes	Yes	Yes	Yes
• permissible range, lower limit (DC)	20.4 V	20.4 V	20.4 V	20.4 V
• permissible range, upper limit (DC)	28.8 V	28.8 V	28.8 V	28.8 V

SIMATIC S7-300

SIPLUS central processing units

SIPLUS compact CPUs

Technical specifications (continued)

	6AG1 312-5BD01-2AB0	6AG1 313-5BE01-2AB0	6AG1 313-6CE01-2AB0	6AG1 314-6CF02-2AB0
Current consumption				
Inrush current, typ.	3 A	11 A	11 A	11 A
I^2t				0.7 A ² s
Current consumption (in no-load operation), typ.	60 mA	150 mA	100 mA	150 mA
Current consumption (rated value)				1,000 mA
from supply voltage L+, max.	500 mA	700 mA	900 mA	1,000 mA
Power loss, typ.	6 W	14 W	10 W	14 W
Memory				
Memory				
• RAM				
- integrated	16 KByte; for program and data, less the display data	32 KByte; for program and data, less the display data	32 KByte; for program and data, less the display data	64 KByte; for program and data, less the display data
- expandable	No	No	No	No
• Load memory				
- pluggable (MMC)	Yes	Yes	Yes	Yes
- pluggable (MMC), max.	4 MByte	8 MByte	8 MByte	8 MByte
Backup				
• present				
	Yes; Guaranteed by MMC (maintenance-free)	Yes; Guaranteed by MMC (maintenance-free)	Yes; Guaranteed by MMC (maintenance-free)	Yes; Guaranteed by MMC (maintenance-free)
• without battery				
	Yes; Program and data	Yes; Program and data	Yes; Program and data	Yes; Program and data
CPU/blocks				
DB				
• Number, max.				
	511; Number band: 1 to 511	511; Number band: 1 to 511	511; Number band: 1 to 511	511; Number band: 1 to 511
• Size, max.				
	16 KByte	16 KByte	16 KByte	16 KByte
FB				
• Number, max.				
	512; Number band: 0 to 2047	512; Number band: 0 to 2047	512; Number band: 0 to 2047	512; Number band: 0 to 2047
• Size, max.				
	16 KByte	16 KByte	16 KByte	16 KByte
FC				
• Number, max.				
	512; Number band: 0 to 2047	512; Number band: 0 to 2047	512; Number band: 0 to 2047	512; Number band: 0 to 2047
• Size, max.				
	16 KByte	16 KByte	16 KByte	16 KByte
OB				
• Size, max.				
	16 KByte	16 KByte	16 KByte	16 KByte
Nesting depth				
• per priority class				
	8	8	8	8
• additional within an error OB				
	4	4	4	4
CPU/processing times				
for bit operations, min.	0.2 µs	0.1 µs	0,1 µs	0.1 µs
for word operations, min.	0.4 µs	0.2 µs	0.2 µs	0.2 µs
for fixed point arithmetic, min.	5 µs	2 µs	2 µs	2 µs
for floating point arithmetic, min.	6 µs	3 µs	3 µs	3 µs
Times/counters and their remanence				
S7 counter				
• Number				
	128	256	256	256

SIMATIC S7-300

SIPLUS central processing units

SIPLUS compact CPUs

4

Technical specifications (continued)

	6AG1 312-5BD01-2AB0	6AG1 313-5BE01-2AB0	6AG1 313-6CE01-2AB0	6AG1 314-6CF02-2AB0
S7 counter (continued)				
• of which remanent without battery				
- adjustable	Yes	Yes	Yes	Yes
- lower limit	0	0	0	0
- upper limit	128	256	256	256
• Counting range				
- lower limit	0	0	0	0
- upper limit	999	999	999	999
IEC counter				
• present	Yes	Yes	Yes	Yes
• Type	SFB	SFB	SFB	SFB
S7 times				
• Number	128	256	256	256
• Remanence				
- adjustable	Yes	Yes	Yes	Yes
- lower limit	0	0	0	0
- upper limit	128	256	256	256
- preset	no retentivity	no retentivity	no retentivity	no retentivity
• Time range				
- lower limit	10 ms	10 ms	10 ms	10 ms
- upper limit	9,990 s	9,990 s	9,990 s	9,990 s
IEC timer				
• present	Yes	Yes	Yes	Yes
• Type	SFB	SFB	SFB	SFB
Data areas and their remanence				
Flag				
• Number, max.	128 Byte	256 Byte	256 Byte	256 Byte
• Remanence available	Yes; MB 0 to MB 127	Yes; MB 0 to MB 255	Yes; MB 0 to MB 255	Yes; MB 0 to MB 255
• Number of clock memories	8; 1 memory byte	8; 1 memory byte	8	8
Data blocks				
• Number, max.	511; from DB1 to DB511	511; from DB1 to DB511	511	511
• Size, max.	16 KByte	16 KByte	16 KByte	16 KByte
Local data				
• per priority class, max.	256 Byte	510 Byte		510 Byte
Address area				
I/O address area				
• Inputs	1 KByte	1 KByte	1 KByte	1 KByte
• Outputs	1 KByte	1 KByte	1 KByte	1 KByte
Process image				
• Inputs	128 Byte	128 Byte	128 Byte	128 Byte
• Outputs	128 Byte	128 Byte	128 Byte	128 Byte
Digital channels				
• Inputs	256	992	8,192	992
• Outputs	256	992	8,192	992
• Inputs, of which central	256	992	992	992
• Outputs, of which central	256	992	992	992
Analog channels				
• Inputs	64	248	248	512
• Outputs	32	124	124	124
• Inputs, of which central		248	248	248
• Outputs, of which central		248	248	248

SIMATIC S7-300

SIPLUS central processing units

SIPLUS compact CPUs

Technical specifications (continued)

	6AG1 312-5BD01-2AB0	6AG1 313-5BE01-2AB0	6AG1 313-6CE01-2AB0	6AG1 314-6CF02-2AB0
Hardware config.				
Central devices, max.	1	1	1	1
Expansion devices, max.	0	3	3	3
Racks, max.	1	4	4	4
Modules per rack, max.	8	8; in rack 3 max. 7	8; in rack 3 max. 7	8; in rack 3 max. 7
Number of DP masters				
• integrated			1	1
• via CP	4	4	4	4
Number of operable FMs and CPs (recommended)				
• FM	8	8	8	8
• CP, point-to-point	8	8	8	8
• CP, LAN	4	6	6	10
Time				
Clock				
• Hardware clock (real-time clock)		Yes	Yes	Yes
• Software clock	Yes			
• Battery backed and synchronized	No	Yes	Yes	Yes
• Deviation per day, max.		10 s	10 s	10 s
Operating hours counter				
• Number	1	1	1	1
• Number/Number range	0	0	0	0
• Range of values	2 [^] 31 hours (when using the SFC 101)	2 [^] 31 hours (when using the SFC 101)	2 [^] 31 hours (when using the SFC 101)	2 [^] 31 hours (when using the SFC 101)
• Granularity	1 hour	1 hour	1 hour	1 hour
• remanent	Yes; must be restarted at each warm restart	Yes; must be restarted at each warm restart	Yes	Yes
Clock synchronization				
• supports	Yes	Yes	Yes	Yes
• to MPI, Master	Yes	Yes	Yes	Yes
• to MPI, Slave	Yes	Yes	Yes	Yes
• in AS, Master	Yes	Yes	Yes	Yes
S7 message functions				
Number of login stations for message functions, max.	6; depending on the configured connections for PG-/ OP- and S7-basic communication	8; depending on the configured connections for PG-/ OP- and S7-basic communication	8	12
Process diagnostic messages	Yes	Yes	Yes	Yes
simultaneously active Alarm-S blocks, max.	20	20	20	40
Test commissioning functions				
Status/control				
• Status/control variable	Yes	Yes	Yes	Yes
• Variables	Inputs, outputs, memory bits, DB, times, counters	Inputs, outputs, memory bits, DB, times, counters	Inputs, outputs, memory bits, DB, times, counters	Inputs, outputs, memory bits, DB, times, counters

SIMATIC S7-300

SIPLUS central processing units

SIPLUS compact CPUs

4

Technical specifications (continued)

	6AG1 312-5BD01-2AB0	6AG1 313-5BE01-2AB0	6AG1 313-6CE01-2AB0	6AG1 314-6CF02-2AB0
Monitoring functions				
• Number of variables, max.	30	30	30	30
• of which status variable, max.	30	30	30	30
• of which control variable, max.	14	14	14	14
Forcing				
• Forcing	Yes	Yes	Yes	Yes
• Force, variables	Inputs, outputs	Inputs, outputs	Inputs, outputs	Inputs, outputs
• Forcing, number of variables, max.	10	10	10	10
Status block	Yes	Yes	Yes	Yes
Single step	Yes	Yes	Yes	Yes
Number of breakpoints	2	2	2	2
Diagnostic buffer				
• present				Yes
• Number of entries, max.				100
Communication functions				
PG/OP communication	Yes	Yes	Yes	Yes
Routing				
Global data communication				Yes
• supported	Yes	Yes	Yes	Yes
• Size of GD packets, max.	22 Byte	22 Byte	22 Byte	22 Byte
S7 basic communication				
• supported	Yes	Yes	Yes	Yes
S7 communication				
• supported	Yes	Yes	Yes	Yes
S5-compatible communication				
• supported	Yes; via CP and loadable FC	Yes; via CP and loadable FC	Yes; via CP and loadable FC	Yes; via CP and loadable FC
Number of connections				
• overall	6	8	8	12
• usable for PG communication	5	7	7	11
• usable for OP communication	5	7	7	11
• usable for S7 basic communication	2	4	4	8
• usable for routing			4	4
Connection point				
required front connectors	1 x 40-pin	2 x 40-pin	1 x 40-pin	2 x 40-pin
MPI				
Cable length, max.	50 m; without repeater	50 m; without repeater	50 m; without repeater	50 m; without repeater
1st interface				
Type of interface	integrated RS 422/ 485 interface	integrated RS 422/ 485 interface	integrated RS 422/ 485 interface	integrated RS 422/ 485 interface
Physics	RS 485	RS 485	RS 485	RS 485
isolated	No	No	Yes	No
Power supply to interface (15 to 30 V DC), max.	200 mA	200 mA	200 mA	200 mA
Functionality				
• MPI	Yes	Yes	Yes	Yes
• DP master	No	No	No	No
• DP slave	No	No	No	No
• Point-to-point coupling	No	No	No	No

SIMATIC S7-300

SIPLUS central processing units

SIPLUS compact CPUs

Technical specifications (continued)

	6AG1 312-5BD01-2AB0	6AG1 313-5BE01-2AB0	6AG1 313-6CE01-2AB0	6AG1 314-6CF02-2AB0
MPI				
• Number of connections	6	8	8	12
• Services				
- PG/OP communication	Yes	Yes	Yes	Yes
- Routing	No	No	Yes	Yes
- Global data communication	Yes	Yes	Yes	Yes
- S7 basic communication	Yes		Yes	Yes
- S7 communication	Yes	Yes	Yes	Yes
- S7 communication, as client	No	No	No	No
- S7 communication, as server	Yes	Yes	Yes	Yes
• Transmission speeds, max.	187.5 kBit/s	187.5 kBit/s	187.5 kBit/s	187.5 kBit/s
2nd interface				
Type of interface			integrated RS 422/ 485 interface	integrated RS 422/ 485 interface
Physics			RS 485	RS 485
isolated			Yes	Yes
Power supply to interface (15 to 30 V DC), max.			200 mA	200 mA
Functionality				
• MPI			No	No
• DP master			Yes	Yes
• DP slave			Yes	Yes
• Point-to-point coupling			No	No
DP master				
• Number of connections, max.			8; for PG/OP communication	8; for PG/OP communication
• Number of connections (of which reserved), max.			1 for PG, 1 for OP	1 for PG, 1 for OP
• Services				
- PG/OP communication			Yes	Yes
- Routing			Yes	Yes
- Global data communication			No	No
- S7 basic communication			Yes	Yes
- S7 communication			Yes	Yes
- S7 communication, as client			No	No
- S7 communication, as server			Yes	Yes
- equidistance support			Yes	Yes
- SYNC/FREEZE			Yes	Yes
- Activation/deactivation of DP slaves			Yes	Yes
- direct data exchange (cross traffic)			Yes	Yes
- DPV1			Yes	Yes
• Transmission speeds, max.			12 Mbit/s	12 Mbit/s
• Number of DP slaves, max.			32	32
• Address area				
- Inputs, max.			1 KByte	1 KByte
- Outputs, max.			1 KByte	1 KByte
• Useful data per DP slave				
- Inputs, max.			244 Byte	244 Byte
- Outputs, max.			244 Byte	244 Byte

SIMATIC S7-300

SIPLUS central processing units

SIPLUS compact CPUs

4

Technical specifications (continued)

	6AG1 312-5BD01-2AB0	6AG1 313-5BE01-2AB0	6AG1 313-6CE01-2AB0	6AG1 314-6CF02-2AB0
DP slave				
• Number of connections			8	12
• Services				
- PG/OP communication			Yes	Yes
- Routing			Yes	Yes
- Global data communication			No	No
- S7 basic communication			Yes	Yes
- direct data exchange (cross traffic)			Yes	Yes
- DPV1			No	No
• GSD file			You can obtain the current GSD file from http://www.ad.siemens.de/support in the Product Support area	You can obtain the current GSD file from http://www.ad.siemens.de/support in the Product Support area
• Transmission speeds, max.			12 kBit/s	12 kBit/s
• automatic baud rate search			Yes	Yes
• Transfer memory				
- Inputs			244 Byte	244 Byte
- Outputs			244 Byte	244 Byte
• Address area, max.			32	32
• Useful data per address area, max.			32 Byte	32 Byte
CPU/programming				
Programming language				
• STEP 7	Yes; V5.1 SP2	Yes; V5.1 SP2	Yes; V5.1 SP2	Yes; V5.2 SP1 with HW update
• LAD	Yes	Yes	Yes	Yes
• FUP	Yes	Yes	Yes	Yes
• AWL	Yes	Yes	Yes	Yes
• SCL	Yes	Yes	Yes	Yes
• CFC				Yes
• GRAPH	Yes	Yes	Yes	Yes
• HiGraph	Yes	Yes	Yes	Yes
Software libraries				
Operational stocks	see Instruction List	see Instruction List	see Instruction List	see Instruction List
Nesting levels	8	8	8	8
User program protection/password protection	Yes	Yes	Yes	Yes
System functions (SFC)	see Instruction List	see Instruction List	see Instruction List	see Instruction List
System function blocks (SFB)	see Instruction List	see Instruction List	see Instruction List	see Instruction List
Digital inputs				
Number of digital inputs	10	24	16	24
Cable length				
• Cable length, shielded, max.	1,000 m; 100 m for technological functions	1,000 m; 100 m for technological functions	1,000 m; 100 m for technological functions	1,000 m; 100 m for technological functions
• Cable length unshielded, max.	600 m	600 m	600 m	600 m
Input voltage				
• Rated value, DC	24 V	24 V	24 V	24 V
• for signal "0"	-3 to 5 V	-3 to 5 V	-3 to 5 V	-3 to 5 V
• for signal "1"	15 to 30 V	15 to 30 V	15 to 30 V	15 to 30 V

SIMATIC S7-300

SIPLUS central processing units

SIPLUS compact CPUs

Technical specifications (continued)

	6AG1 312-5BD01-2AB0	6AG1 313-5BE01-2AB0	6AG1 313-6CE01-2AB0	6AG1 314-6CF02-2AB0
Input current				
• for signal "1", typ.	8 mA	8 mA	8 mA	8 mA
Input delay (for rated value of input voltage)				
• for standard inputs - programmable	Yes; 0.1 / 0.3 / 3 / 15 ms	Yes; 0.1 / 0.3 / 3 / 15 ms	Yes; 0.1 / 0.3 / 3 / 15 ms	Yes; 0.1 / 0.3 / 3 / 15 ms
• for counter/technological functions - at "0" to "1", max.	50 µs	16 µs	8 µs	8 µs
Digital outputs				
Number of digital outputs	6	16	16	16
Cable length, shielded, max.	1,000 m	1,000 m	1,000 m	1,000 m
Cable length unshielded, max.	600 m	600 m	600 m	600 m
Short-circuit protection of the output	Yes; clocked electronically	Yes; clocked electronically	Yes; clocked electronically	Yes; clocked electronically
Limitation of inductive shutdown voltage to	L+ (-48 V)	L+ (-48 V)	L+ (-48 V)	L+ (-48 V)
Output voltage				
• for signal "1", min.	L+ (-0,8 V)	L+ (-0,8 V)	L+ (-0,8 V)	L+ (-0,8 V)
Output current				
• for signal "1" permissible range for 0 to 40 °C, max.	500 mA	500 mA	500 mA	500 mA
• for signal "1" permissible range for 0 to 60 °C, max.	500 mA	500 mA	500 mA	500 mA
• for signal "1" minimum load current	5 mA	5 mA	5 mA	5 mA
• for signal "0" residual current, max.	0,5 mA	0,5 mA	0,5 mA	0,5 mA
Switching frequency				
• with resistive load, max.	100 Hz	100 Hz	100 Hz	100 Hz
• with inductive load, max.	0.5 Hz	0.5 Hz	0.5 Hz	0.5 Hz
Aggregate current of the outputs (per group)				
• all other mounting positions				
• up to 40 °C, max.	3 A	8 A	8 A	8 A
• up to 60 °C, max.	1.5 A	4 A	4 A	4 A
Analog inputs				
Number of analog inputs for voltage/current measurement		4		4
Number of analog inputs for resistance/temperature measurement		1		1
Technical unit for temperature measurement, adjustable		Yes		Yes
Input ranges (rated values), voltages				
• 0 to +10 V		Yes		Yes
• -10 V to +10 V		Yes		Yes
Input ranges (rated values), currents				
• 0 to 20 mA		Yes		Yes
• -20 to +20 mA		Yes		Yes
• 4 to 20 mA		Yes		Yes

SIMATIC S7-300

SIPLUS central processing units

SIPLUS compact CPUs

4

Technical specifications (continued)

	6AG1 312-5BD01-2AB0	6AG1 313-5BE01-2AB0	6AG1 313-6CE01-2AB0	6AG1 314-6CF02-2AB0
Input ranges (rated values), resistors • 0 to 600 Ohm		Yes		Yes
Input ranges (rated values), resistance thermometers • Pt 100		Yes		Yes
Analog outputs				
Number of analog outputs		2		2
Output ranges, voltage • 0 to 10 V • -10 to +10 V		Yes Yes		Yes Yes
Output ranges, current • 0 to 20 mA • -20 to +20 mA • 4 to 20 mA		Yes Yes Yes		Yes Yes Yes
Analog value creation				
Integrations and conversion time/resolution per channel • Resolution with overload area (bit including sign), max. • Integration time, parameterizable • Conversion time (per channel)		12 Bit Yes; 2.5 / 16.6 / 20 ms 1 ms		12 Bit Yes; 2.5 / 16.6 / 20 ms 1 ms
Encoder				
Connectable encoders • 2-wire BEROS • permissible quiescent current (2-wire BEROS), max.	Yes 1.5 mA	Yes 1.5 mA	Yes 1.5 mA	Yes 1.5 mA
Errors/accuracies				
Basic error limit (operational limit at 25 °C) • Voltage, relative to output area • Current, relative to output area • Voltage, relative to input area • Current, relative to input area • Impedance, relative to input area • Resistance-type thermometer, relative to input area		+/- 0,7 % +/- 0,7 % +/- 0,7 % +/- 0,7 % +/- 3 % +/- 3 %		+/- 0,7 % +/- 0,7 % +/- 0,7 % +/- 3 % +/- 3 %
Integrated Functions				
Number of counters	2; 2 channels (see "Technological Functions" manual)	3; 3 channels (see "Technological Functions" manual)	3	4
Counter frequency (counter) max.	10 kHz	30 kHz	30 kHz	60 kHz
Frequency measurement	Yes	Yes	Yes	Yes
Controlled positioning	No	No	No	Yes
PID controller	No	Yes	Yes	Yes

SIMATIC S7-300

SIPLUS central processing units

SIPLUS compact CPUs

Technical specifications (continued)

	6AG1 312-5BD01-2AB0	6AG1 313-5BE01-2AB0	6AG1 313-6CE01-2AB0	6AG1 314-6CF02-2AB0
Number of pulse outputs	2; 2 channels pulse width modulation up to 2.5 kHz (see Manual "Technological Functions")	3; 3 channels pulse width modulation up to 2.5 kHz (see Manual "Technological Functions")	3	4
Limit frequency (pulse)	2.5 kHz	2.5 kHz	2.5 kHz	2.5 kHz
Isolation				
Isolation, analog outputs				
• Galvanic isolation, analog outputs		Yes		Yes
• between the channels and the backplane bus		Yes		Yes
Isolation, analog inputs				
• Isolation, analog inputs		Yes		Yes
• between the channels and the backplane bus		Yes		Yes
Isolation, digital outputs				
• Galvanic isolation, digital outputs	Yes	Yes	Yes	Yes
• between the channels, in groups of	6	8	8	8
• between the channels and the backplane bus	Yes	Yes	Yes	Yes
Galvanic isolation, digital inputs				
• galvanic isolation, digital inputs	Yes	Yes	Yes	Yes
• between the channels, in groups of	10	16; and 8	16	16
• between the channels and the backplane bus	Yes	Yes	Yes	Yes
Dimensions and weight				
Width	80 mm	120 mm	120 mm	120 mm
Height	125 mm	125 mm	125 mm	125 mm
Depth	130 mm	130 mm	130 mm	130 mm
Weights				
Weight, approx.	409 g	660 g	566 g	676 g

SIMATIC S7-300

SIPLUS central processing units

SIPLUS compact CPUs

Ordering data	Order No.	Ordering data	Order No.
SIPLUS CPU 312C (extended temperature range and medial load) Compact CPU, main memory 16 KB, power supply 24 V DC, 10 DI/6 DO integrated, integrated functions, MPI; including slot number labels and 2 keys; MMC is required	6AG1 312-5BD01-2AB0	SIPLUS CPU 313C-2 DP (extended temperature range and medial load) Compact CPU, main memory 32 KB, power supply 24 V DC, 16 DI/16 DO integrated, integrated functions, MPI PROFIBUS DP master/slave interface; MMC is required	6AG1 313-6CE01-2AB0
SIPLUS CPU 313C ^{A)} (extended temperature range and medial load) Compact CPU, main memory 32 KB, power supply 24 V DC, 24 DI/16 DO, 4 AI/2 AO integrated, integrated functions, MPI; MMC is required	6AG1 313-5BE01-2AB0	SIPLUS CPU 314C-2 DP (extended temperature range and medial load) Compact CPU, main memory 64 KB, power supply 24 V DC, 24DI/16DO/4AI/2AO integrated, integrated functions, MPI; PROFIBUS DP master/slave interface; MMC is required	6AG1 314-6CF02-2AB0
		Accessories	see S7-300 Compact CPUs, page 4/19

A) Subject to export regulations: AL: N and ECCN: EAR99H

SIMATIC S7-300

SIPLUS central processing units

SIPLUS standard CPUs

Overview SIPLUS CPU 314



- For installations with medium requirements on program scope
- High processing performance in binary and floating-point arithmetic

Micro memory card required to operate the CPU.

	SIPLUS CPU 314
Order No.	6AG1 314-1AF11-2AB0
Order No. based on	6ES7 314-1AF11-0AB0
Ambient temperature range	-25 °C to +60 °C, condensation permissible
Ambient conditions	Suitable for extraordinary medial load (for example by chloric and sulphuric atmospheres).
Conformity with standard for electronic devices on rail vehicles (EN 50155, temperature T1, category 1)	Yes
Technical specifications	The technical data are identical with the technical data of the based on modules.

Overview CPU 315-2 DP



- The CPU with medium to large program memory and quantity framework for the use, if required, of SIMATIC Engineering Tools
- High processing performance in binary and floating-point arithmetic
- PROFIBUS DP master/slave interface
- For extensive I/O configurations
- For setting up distributed I/O structures

Micro memory card required to operate the CPU.

	SIPLUS CPU 315-2 DP
Order No.	6AG1 315-2AG10-2AB0
Order No. based on	6ES7 315-2AG10-0AB0
Ambient temperature range	-25 °C to +60 °C, condensation permissible
Ambient conditions	Suitable for extraordinary medial load (for example by chloric and sulphuric atmospheres).
Conformity with standard for electronic devices on rail vehicles (EN 50155, temperature T1, category 1)	Yes
Technical specifications	The technical data are identical with the technical data of the based on modules.

SIMATIC S7-300

SIPLUS central processing units

SIPLUS standard CPUs
Overview SIPLUS CPU 315-2 PN/DP

- The CPU with a medium program memory and quantity framework
- High processing performance in binary and floating-point arithmetic
- Used as a central controller on production lines with central and distributed I/O
- Integral PROFINET interface
- Combined MPI/PROFIBUS DP-master/slave interface
- Component Based Automation (CBA) on PROFINET
- PROFINET proxy for intelligent devices on PROFIBUS DP in Component Based Automation (CBA)
- PROFINET I/O Controller for operating distributed I/O on PROFINET

Micro memory card required to operate the CPU.

	SIPLUS CPU 315-2 PN/DP
Order No.	6AG1 315-2EG10-2AB0
Order No. based on	6ES7 315-2EG10-0AB0
Ambient temperature range	-25 °C to +60 °C, condensation permissible
Ambient conditions	Suitable for extraordinary medial load (for example by chloric and sulphuric atmospheres).
Technical data	The technical data are identical with the technical data of the based on modules.

Overview SIPLUS CPU 317-2 PN/DP

- The CPU with a large program memory and quantity framework for demanding requirements
- Distributed intelligence in Component Based Automation (CBA) on PROFINET
- PROFINET proxy for intelligent devices on PROFIBUS DP in Component Based Automation (CBA)
- PROFINET I/O controller for operating distributed I/O on PROFINET
- For multisector automation tasks in the construction of series machines, special machines and plants
- Used as a central controller on production lines with central and distributed I/O
- For extensive I/O configurations
- For setting up distributed I/O structures
- High processing performance in binary and floating-point arithmetic
- Combined MPI/PROFIBUS DP master/slave interface
- Supports as an option the use of SIMATIC Engineering Tools

Micro memory card required to operate the CPU.

	SIPLUS CPU 317-2 PN/DP
Order No.	6AG1 317-2EJ10-2AB0
Order No. based on	6ES7 317-2EJ10-0AB0
Ambient temperature range	-25 °C to +60 °C, condensation permissible
Ambient conditions	Suitable for extraordinary medial load (for example by chloric and sulphuric atmospheres).
Technical data	The technical data are identical with the technical data of the based on modules.

Technical specifications

	6AG1 314-1AF11-2AB0	6AG1 315-2AG10-2AB0	6AG1 315-2EG10-2AB0	6AG1 317-2EJ10-2AB0
Product status				
associated programming package	STEP 7 V 5.2 or higher + SP 1 with HW update	STEP 7 V 5.1 or higher + SP 4	STEP 7 V5.3 SP1	STEP 7 V5.3 or higher
Supply voltages				
Rated value				
• DC 24 V	Yes	Yes	Yes	Yes
• permissible range, lower limit (DC)	20.4 V	20.4 V	20.4 V	20.4 V

www.DataSheet4U.com

SIMATIC S7-300

SIPLUS central processing units

SIPLUS standard CPUs

Technical specifications (continued)

	6AG1 314-1AF11-2AB0	6AG1 315-2AG10-2AB0	6AG1 315-2EG10-2AB0	6AG1 317-2EJ10-2AB0
Rated value (continued)				
• permissible range, upper limit (DC)	28.8 V	28.8 V	28.8 V	28.8 V
Voltages and currents				
external protection for supply cables (recommendation)	min. 2 A	min. 2 A	min. 2 A	min. 2 A
Current consumption				
Inrush current, typ.	2,5 A	2,5 A	2,5 A	2,5 A
I ² t	0,5 A ² s	0,5 A ² s	1 A ² s	1 A ² s
Current consumption (in no-load operation), typ.	60 mA	60 mA	100 mA	100 mA
Current consumption (rated value)	0,6 A			
from supply voltage L+, max.	600 mA	800 mA		
Power loss, typ.	2.5 W	2.5 W	3.5 W	3.5 W
Memory				
Memory				
• RAM				
- integrated	64 KByte	128 KByte	128 KByte	512 KByte
- expandable	No	No	No	No
• Load memory				
- pluggable (MMC)	Yes	Yes	Yes	Yes
- pluggable (MMC), max.	8 MByte	8 MByte	8 MByte	8 MByte
Backup				
• present	Yes; Guaranteed by MMC (maintenance-free)	Yes; Guaranteed by MMC (maintenance-free)	Yes; Guaranteed by MMC (maintenance-free)	Yes; Guaranteed by MMC (maintenance-free)
CPU/blocks				
DB				
• Number, max.	511; Number band: 1 to 511	1,024; Number band: 1 to 1023	1,023; Number band: 1 to 1023	2,047; Number band: 1 to 2047
• Size, max.	16 KByte	16 KByte	16 KByte	64 KByte
FB				
• Number, max.	512; Number band: 0 to 2047	2,048; Number band: 0 to 2047	2,048; Number band: 0 to 2047	2,048; Number band: 0 to 2047
• Size, max.	16 KByte	16 KByte	16 KByte	64 KByte
FC				
• Number, max.	512; Number band: 0 to 2047	2,048; Number band: 0 to 2047	2,048; Number band: 0 to 2047	2,048; Number band: 0 to 2047
• Size, max.	16 KByte	16 KByte	16 KByte	64 KByte
OB				
• Size, max.	16 KByte	16 KByte	16 KByte	64 KByte
Nesting depth				
• per priority class	8	8	8	16
• additional within an error OB	4	4	4	4
CPU/processing times				
for bit operations, min.	0.1 µs	0.1 µs	0.1 µs	0.05 µs
for word operations, min.	0.2 µs	0.2 µs	0.2 µs	0.2 µs
for fixed point arithmetic, min	2 µs	2 µs	2 µs	0.2 µs
for floating point arithmetic, min.	3 µs	3 µs	3 µs	1 µs

SIMATIC S7-300

SIPLUS central processing units

SIPLUS standard CPUs

4

Technical specifications (continued)

	6AG1 314-1AF11-2AB0	6AG1 315-2AG10-2AB0	6AG1 315-2EG10-2AB0	6AG1 317-2EJ10-2AB0
Times/counters and their remanence				
S7 counter				
• Number	256	256	256	512
• of which remanent without battery				
- adjustable	Yes	Yes	Yes	Yes
• Remanence				
- adjustable	Yes	Yes	Yes	
• Counting range				
- adjustable	Yes	Yes	Yes	Yes
- lower limit	0	0	0	0
- upper limit	999	999	999	999
IEC counter				
• present	Yes	Yes	Yes	Yes
• Type	SFB	SFB	SFB	SFB
S7 times				
• Number	256	256	256	512
• Remanence				
- adjustable	Yes	Yes	Yes	Yes
- preset	No retentivity	No retentivity	No retentivity	No retentivity
• Time range				
- lower limit	10 ms	10 ms	10 ms	10 ms
- upper limit	9,990 s	9,990 s	9,990 s	9,990 s
IEC timer				
• present	Yes	Yes	Yes	Yes
• Type	SFB	SFB	SFB	SFB
Data areas and their remanence				
Flag				
• Number, max.	256 Byte	2,048 Byte	2,048 Byte	4,096 Byte
• Remanence available	Yes; MB 0 to MB 255	Yes; MB 0 to MB 2047	Yes; MB 0 to MB 2047	Yes; MB 0 to MB 4095
• Number of clock memories	8; 1 memory byte	8; 1 memory byte	8; 1 memory byte	8; 1 memory byte
Data blocks				
• Number, max.	511; from DB1 to DB511	1,023; from DB 1 to DB 1023	1,023; from DB 1 to DB 1023	2,047; from DB 1 to DB 2047
• Size, max.	16 KByte	16 KByte; Local data size: max. 1024 bytes per priority class/ 510 bytes per block	16 KByte	64 KByte
• Remanence adjustable				Yes; via non-retain property on DB
Local data				
• per priority class, max.	510 Byte	128 Byte	1,024 Byte; per block max. 510	1,024 Byte
Address area				
I/O address area				
• Inputs	1 KByte	2 KByte	2,048 Byte	8 KByte
• Outputs	1 KByte	2 KByte	2,048 Byte	8 KByte
• of which, distributed				
- Inputs		2 KByte	2 KByte	8 KByte
- Outputs		2 KByte	2 KByte	8 KByte

SIMATIC S7-300

SIPLUS central processing units

SIPLUS standard CPUs

Technical specifications (continued)

	6AG1 314-1AF11-2AB0	6AG1 315-2AG10-2AB0	6AG1 315-2EG10-2AB0	6AG1 317-2EJ10-2AB0
Process image				
• Inputs	128 Byte	128 Byte	128 Byte	256 Byte
• Outputs	128 Byte	128 Byte	128 Byte	256 Byte
• Inputs, adjustable				2,048 KByte
• Outputs, adjustable				2,048 KByte
• Inputs, preset				256 Byte
• Outputs, preset				256 Byte
Digital channels				
• Inputs	1,024	16,384	16,384	65,536
• Outputs	1,024	16,384	16,384	65,536
• Inputs, of which central	1,024	1,024	1,024; max.	1,024
• Outputs, of which central	1,024	1,024	1,024; max.	1,024
Analog channels				
• Inputs	256	1,024	1,024	4,096
• Outputs	256	1,024	1,024	4,096
• Inputs, of which central	256	256	256; max.	256
• Outputs, of which central	256	256	256; max.	256
Hardware config.				
Racks, max.	4	4	4	4
Modules per rack, max.	8	8	8	8
Number of DP masters				
• integrated	0	1	1	1
• via CP	4	4	4	4
Number of operable FMs and CPs (recommended)				
• FM	8	8	8	8
• CP, point-to-point	8	8	8	8
• CP, LAN	10	10	10	10
Time				
Clock				
• Hardware clock (real-time clock)	Yes	Yes	Yes	Yes
• Battery backed and synchronized	Yes	Yes	Yes	Yes
• Deviation per day, max.	10 s	10 s	10 s	10 s
Operating hours counter				
• Number	1	1	1	4
• Number/Number range	0	0	0	0 to 3
• Range of values	0 to 2 ³¹ hours (when using SFC101)	0 to 2 ³¹ hours (when using SFC101)	2 to the power of 31 hours (when using the SFC 101)	0 to 2 ³¹ hours (when using SFC101)
• Granularity	1 hour	1 hour	1 hour	1 hour
• remanent	Yes; must be restarted at each warm restart	Yes; must be restarted at each warm restart	Yes; must be restarted at each warm restart	Yes; must be restarted at each warm restart
Clock synchronization				
• supports	Yes	Yes	Yes	Yes
• to MPI, Master	Yes	Yes	Yes	Yes
• to MPI, Slave	Yes	Yes	Yes	Yes
• in AS, Master	Yes	Yes	Yes	Yes
• in AS, Slave			Yes	Yes
S7 message functions				
Number of login stations for message functions, max.	12; depending on the configured connections for PG/OP and S7 basic communication	16; depending on the configured connections for PG-/ OP- and S7-basic communication	16; depending on the configured connections for PG-/ OP- and S7-basic communication	32; depending on the configured connections for PG-/ OP- and S7-basic communication

SIMATIC S7-300

SIPLUS central processing units

SIPLUS standard CPUs
4
Technical specifications (continued)

	6AG1 314-1AF11-2AB0	6AG1 315-2AG10-2AB0	6AG1 315-2EG10-2AB0	6AG1 317-2EJ10-2AB0
Process diagnostic messages	Yes	Yes	Yes	Yes
Simultaneously active Alarm-S blocks, max.	40	40	40	60
Test commissioning functions				
Status/control				
• Status/control variable	Yes	Yes	Yes	Yes
• Variables	Inputs, outputs, memory bits, DB, times, counters	Inputs, outputs, memory bits, DB, times, counters	Inputs, outputs, memory bits, DB, times, counters	Inputs, outputs, memory bits, DB, times, counters
Monitoring functions				
• Number of variables, max.	30	30	30	30
• of which status variable, max.	30	30	30	30
• of which control variable, max.	14	14	14	14
Forcing				
• Forcing	Yes	Yes	Yes	Yes
• Force, variables	Inputs, outputs	Inputs, outputs	Inputs, outputs	Inputs, outputs
• Forcing, number of variables, max.	10	10	10	10
Status block	Yes	Yes	Yes	Yes
Single step	Yes	Yes	Yes	Yes
Number of breakpoints	2	2	2	2
Diagnostic buffer				
• present	Yes	Yes	Yes	Yes
• Number of entries, max.	100	100	100	100
• adjustable	No	No	No	
Communication functions				
PG/OP communication	Yes	Yes	Yes	Yes
Routing	No	Yes	Yes	Yes
Global data communication				
• supported	Yes	Yes	Yes	Yes
• Size of GD packets, max.	22 Byte	22 Byte	22 Byte	22 Byte
S7 basic communication				
• supported	Yes	Yes	Yes	Yes
S7 communication				
• supported	Yes	Yes	Yes	Yes
S5-compatible communication				
• supported	Yes; via CP and loadable FC	Yes; via CP and loadable FC	Yes; via CP and loadable FC	Yes; via CP and loadable FC
Open IE communication				
• TCP/IP			Yes; via integrated PROFINET interface and loadable FBs	Yes; via integrated PROFINET interface and loadable FBs
- Number of connections, max.			8	8
- Data length, max.			1,460 Byte	1,460 Byte
Number of connections				
• overall	12	16	16	32
• usable for PG communication	11	15	15; max.	31
• usable for OP communication	11	15	15	31
• usable for S7 basic communication	8	12	14	30
• usable for routing		4		

www.DataSheet4U.com

SIMATIC S7-300

SIPLUS central processing units

SIPLUS standard CPUs

Technical specifications (continued)

	6AG1 314-1AF11-2AB0	6AG1 315-2AG10-2AB0	6AG1 315-2EG10-2AB0	6AG1 317-2EJ10-2AB0
PROFINET CBA (at set setpoint communication load) <ul style="list-style-type: none"> • Setpoint for the CPU communication load • Number of remote interconnection partners • Number of functions, master/slave • Total of all master/slave connections • Data length of all incoming connections master/slave, max. • Data length of all outgoing connections master/slave, max. • Number of device-internal and PROFIBUS interconnections • Data length of device-internal und PROFIBUS interconnections, max. • Data length per connection, max. • Remote interconnections with acyclic transmission <ul style="list-style-type: none"> - Sampling frequency: sampling interval, min. - Number of incoming interconnections - Number of outgoing interconnections - Data length of all incoming interconnections, max. - Data length of all outgoing interconnections, max. - Data length per connection, max. 				50% 32 17 1,000 4,000 Byte 4,000 Byte 500 4,000 Byte 1,400 Byte 500 ms 100 100 2,000 Byte 2,000 Byte 1,400 Byte
<ul style="list-style-type: none"> • Remote interconnections with cyclic transmission <ul style="list-style-type: none"> - Transmission frequency: transmission interval, min. - Number of incoming interconnections - Data length of all incoming interconnections, max. - Data length of all outgoing interconnections, max. - Data length per connection, max. 				10 ms 200 2,000 Byte 2,000 Byte 450 Byte
<ul style="list-style-type: none"> • HMI variables via PROFINET (acyclic) <ul style="list-style-type: none"> - Number of log-in stations for HMI variables (PN OPC/iMap) - HMI variable updating - Number of HMI variables - Data length of all HMI variables, max. 				3; 2 * PN OPC / 1 * iMap 500 ms 200 2,000 Byte

SIMATIC S7-300

SIPLUS central processing units

SIPLUS standard CPUs

4

Technical specifications (continued)

	6AG1 314-1AF11-2AB0	6AG1 315-2AG10-2AB0	6AG1 315-2EG10-2AB0	6AG1 317-2EJ10-2AB0
<ul style="list-style-type: none"> • PROFIBUS proxy functionality <ul style="list-style-type: none"> - supported - Number of linked PROFIBUS devices - Data length per connection, max. 				Yes 16 240 Byte; Slave-dependent
1st interface				
Type of interface	Integral RS 485 interface	Integral RS 485 interface	Integral RS 485 interface	Integral RS 485 interface
Physics	RS 485	RS 485	RS 485	RS 485
isolated	No	No	Yes	Yes
Power supply to interface (15 to 30 V DC), max.	200 mA	200 mA	200 mA	200 mA
Functionality				
<ul style="list-style-type: none"> • MPI • DP master • DP slave • Point-to-point coupling 	Yes No No No	Yes No No No	Yes Yes Yes No	Yes Yes Yes No
MPI				
<ul style="list-style-type: none"> • Number of connections • Services <ul style="list-style-type: none"> - PG/OP communication - Routing - Global data communication - S7 basic communication - S7 communication - S7 communication, as client - S7 communication, as server 	12 Yes No Yes Yes Yes No Yes	16 Yes Yes Yes Yes No Yes	16 Yes Yes Yes Yes No Yes	16 Yes Yes Yes Yes No Yes
<ul style="list-style-type: none"> • Transmission speeds, max. 	187.5 kBit/s	187.5 kBit/s	12 Mbit/s	12 Mbit/s
DP master				
<ul style="list-style-type: none"> • Services <ul style="list-style-type: none"> - PG/OP communication - Routing - Global data communication - S7 basic communication - S7 communication - Equidistance support - SYNC/FREEZE - DPV1 			Yes Yes No Yes Yes Yes Yes Yes	Yes Yes No Yes Yes Yes Yes Yes
<ul style="list-style-type: none"> • Transmission speeds, max. • Number of DP slaves, max. • Address area <ul style="list-style-type: none"> - Inputs, max. - Outputs, max. 			12 Mbit/s 124	12 Mbit/s 124 244 KByte 244 KByte
DP slave				
<ul style="list-style-type: none"> • Services <ul style="list-style-type: none"> - Routing - Global data communication - S7 basic communication - S7 communication - direct data exchange (cross traffic) - DPV1 			Yes; only when interface active No Yes Yes Yes No	Yes; only when interface active No Yes Yes Yes No

SIMATIC S7-300

SIPLUS central processing units

SIPLUS standard CPUs

Technical specifications (continued)

	6AG1 314-1AF11-2AB0	6AG1 315-2AG10-2AB0	6AG1 315-2EG10-2AB0	6AG1 317-2EJ10-2AB0
DP slave (continued)				
• Transmission speeds, max.			12 Mbit/s	12 Mbit/s
• Transfer memory				
- Inputs			244 Byte	244 Byte
- Outputs			244 Byte	244 Byte
• Address area, max.			32; with max. 32 bytes each	32
• Useful data per address area, max.				32 Byte
2nd interface				
Type of interface		Integral RS 485 interface	PROFINET	PROFINET
Physics		RS 485	Ethernet	RJ45
isolated		Yes	Yes	Yes
Power supply to interface (15 to 30 V DC), max.		200 mA	0 mA	0 mA
automatic detection of transmission speed			Yes; (10/100 MBit/s)	Yes; (10/100 MBit/s)
Functionality				
• MPI		No	No	No
• DP master		Yes	No	No
• DP slave		Yes	No	No
• Point-to-point coupling		No	No	No
• PROFINET CBA			Yes	Yes
• PROFINET IO-Controller			Yes	Yes; Yes; Firmware Status V2.3 or higher
DP master				
• Number of connections, max.		16		
• Services				
- PG/OP communication		Yes		
- Routing		Yes		
- Global data communication		No		
- S7 basic communication		Yes		
- S7 communication		Yes		
- S7 communication, as client		No		
- S7 communication, as server		Yes		
- equidistance support		Yes		
- SYNC/FREEZE		Yes		
- DPV1		Yes		
• Transmission speeds, max.		12 Mbit/s		
• Number of DP slaves, max.		124; per station		
• Address area				
- Inputs, max.		244 Byte		
- Outputs, max.		244 Byte		
DP slave				
• Number of connections		16		
• Services				
- PG/OP communication		Yes		
- Routing		Yes; when interface active		
- Global data communication		No		
- S7 basic communication		Yes		
- S7 communication, as client		No		

SIMATIC S7-300

SIPLUS central processing units

SIPLUS standard CPUs

4

Technical specifications (continued)

	6AG1 314-1AF11-2AB0	6AG1 315-2AG10-2AB0	6AG1 315-2EG10-2AB0	6AG1 317-2EJ10-2AB0
<ul style="list-style-type: none"> Services (continued) <ul style="list-style-type: none"> - S7 communication, as server - direct data exchange (cross traffic) - DPV1 		Yes Yes No		
<ul style="list-style-type: none"> GSD file 		http://www.ad.siemens.de/support in Product Support area		
<ul style="list-style-type: none"> Transmission speeds, max. automatic baud rate search 		12 Mbit/s Yes; only with passive interface		
<ul style="list-style-type: none"> Transfer memory <ul style="list-style-type: none"> - Inputs - Outputs Address area, max. Useful data per address area, max. 		244 Byte 244 Byte 32 32 Byte		
PROFINET CBA <ul style="list-style-type: none"> Acyclic transmission cyclic transmission 			Yes Yes	Yes Yes
PROFINET IO controller <ul style="list-style-type: none"> Services <ul style="list-style-type: none"> - PG/OP communication - Routing - S7 communication - open IE communication 			Yes Yes Yes; with loadable FBs, max. configurable connectons: 16 Yes; via TCP/IP	Yes Yes Yes; with loadable FBs, max. configurable connectons: 16 Yes; via TCP/IP
<ul style="list-style-type: none"> Transmission speed, max. Number of connectable IO-devices, max. Address area <ul style="list-style-type: none"> - Inputs, max. - Outputs, max. Useful data consistency, max. 			100 Mbit/s 128 2 KByte 2 KByte 256 Byte	100 Mbit/s 128 8 KByte 8 KByte 256 Byte
CPU/programming				
Programming language <ul style="list-style-type: none"> STEP 7 LAD FUP AWL SCL CFC GRAPH HiGraph 	Yes; V 5.2 SP 1 or higher with HW update Yes Yes Yes Yes Yes Yes Yes	Yes; V 5.1 SP4 or higher Yes Yes Yes Yes Yes Yes Yes	Yes; V 5.3 SP1 or higher Yes Yes Yes Yes Yes Yes Yes	Yes; V 5.3 or higher Yes Yes Yes Yes Yes Yes Yes

SIMATIC S7-300

SIPLUS central processing units

SIPLUS standard CPUs

Technical specifications (continued)

	6AG1 314-1AF11-2AB0	6AG1 315-2AG10-2AB0	6AG1 315-2EG10-2AB0	6AG1 317-2EJ10-2AB0
Software libraries				
Operational stocks	See Operation List	See Operation List	See Operation List	See Operation List
Nesting levels	8	8	8	8
User program protection/password protection	Yes	Yes	Yes	Yes
System functions (SFC)	See Operation List	See Operation List	See Operation List	See Operation List
System function blocks (SFB)	See Operation List	See Operation List	See Operation List	See Operation List
Dimensions and weight				
Width	40 mm	40 mm	80 mm	80 mm
Height	125 mm	125 mm	125 mm	125 mm
Depth	130 mm	130 mm	130 mm	130 mm
Weights				
Weight, approx.	280 g	290 g	460 g	460 g

Ordering data

Ordering data	Order No.	Ordering data	Order No.
SIPLUS CPU 314 A) (extended temperature range and medial load) Main memory 64 KB, power supply 24 V DC, MPI; MMC required	6AG1 314-1AF11-2AB0	SIPLUS CPU 317-2 PN/DP (extended temperature range and medial load) Main memory 512 KB, power supply 24 V DC, combined MPI/PROFIBUS DP master/slave interface, Ethernet/PROFINET interface; MMC required	6AG1 317-2EJ10-2AB0
SIPLUS CPU 315-2 DP A) (extended temperature range and medial load) Main memory 128 KB, power supply 24 V DC, MPI/PROFIBUS DP master/slave interface, MMC required	6AG1 315-2AG10-2AB0	Accessories see S7-300 standard CPUs, page 4/41	
SIPLUS CPU 315-2 PN/DP (extended temperature range and medial load) Main memory 128 KB, power supply 24 V DC, combined MPI/PROFIBUS DP master/slave interface, Ethernet/PROFINET interface; MMC required	6AG1 315-2EG10-2AB0		

A) Subject to export regulations: AL: N and ECCN: EAR99H

SIMATIC S7-300

SIPLUS central processing units

SIPLUS fail-safe CPUs
Overview SIPLUS CPU 315F-2 DP

- For design of a fail-safe automation system for plants with increased safety requirements
- Based on the SIMATIC CPU 315-2 DP
- Complies with safety requirements up to SIL 3 to IEC 61508 and up to Cat. 4 according to EN 954-1
- Distributed fail-safe I/O modules can be connected through the integral PROFIBUS DP interface (PROFIsafe).
- Fail-safe I/O modules of the ET 200M range can also be centrally connected
- Central and distributed use of standard modules for non-safety-relevant applications

Micro memory card required to operate the CPU.

	SIPLUS CPU 315F-2 DP
Order No.	6AG1 315-6FF01-2AB0
Order No. based on	6ES7 315-6FF01-0AB0
Ambient temperature range	-25 °C to +60 °C, condensation permissible
Ambient conditions	Suitable for extraordinary medial load (for example by chloric and sulphuric atmospheres).
Conformity with standard for electronic devices on rail vehicles (EN 50155, temperature T1, category 1)	Yes
Technical data	The technical data are identical with the technical data of the based on modules.

Overview SIPLUS CPU 317F-2 DP

- The fail-safe CPU with a large program memory and quantity framework for demanding applications
- For design of a fail-safe automation system for plants with increased safety requirements
- Complies with safety requirements up to SIL 3 to IEC 61508 and up to Cat. 4 according to EN 954-1
- Distributed fail-safe I/O modules can be connected through the two integral PROFIBUS DP interfaces (PROFIsafe).
- Fail-safe I/O modules of the ET 200M range can also be centrally connected
- Central and distributed use of standard modules for non-safety-relevant applications

Micro memory card required to operate the CPU.

	SIPLUS CPU 317F-2 DP
Order No.	6AG1 317-6FF00-2AB0
Order No. based on	6ES7 317-6FF00-0AB0
Ambient temperature range	-25 °C to +60 °C, condensation permissible
Ambient conditions	Suitable for extraordinary medial load (for example by chloric and sulphuric atmospheres).
Conformity with standard for electronic devices on rail vehicles (EN 50155, temperature T1, category 1)	Yes
Technical data	The technical data are identical with the technical data of the based on modules.

SIMATIC S7-300

SIPLUS central processing units

SIPLUS fail-safe CPUs

Technical specifications

	6AG1 315-6FF01-2AB0	6AG1 317-6FF00-2AB0
Product status		
associated programming package	STEP 7 V5.1 or higher + SP 6	STEP 7 V 5.2 or higher + SP1; S7 Distributed Safety V5.2 + SP1 or higher
Supply voltages		
Rated value		
• DC 24 V	Yes	Yes
• permissible range, lower limit (DC)	20.4 V	20.4 V
• permissible range, upper limit (DC)	28.8 V	28.8 V
Voltages and currents		
external protection for supply cables (recommendation)	min. 2 A	min. 2 A
Current consumption		
Inrush current, typ.	2.5 A	2.5 A
I^2t	0.5 A ² s	0.5 A ² s
Current consumption (in no-load operation), typ.	60 mA	60 mA
Power loss, typ.	2.5 W	2.5 W
Memory		
• RAM		
- integrated		
- expandable	192 KByte; The number of F-instructions compared to a standard program is limited due to the F-specific overheads; depending on the type of programming, about 36 K F-instructions are possible.	512 KByte; of which max. 256 kB for retentive DB
• RAM	No	No
• Load memory		
- pluggable (MMC)	Yes	Yes
- pluggable (MMC), max.	8 MByte	8 MByte
Backup		
• present	Yes; Guaranteed by MMC (maintenance-free)	Yes; Guaranteed by MMC (maintenance-free)
CPU/blocks		
DB		
• Number, max.	1,023; DB 0 reserved	2,047; DB 0 reserved
• Size, max.	16 KByte	64 KByte

	6AG1 315-6FF01-2AB0	6AG1 317-6FF00-2AB0
FB		
• Number, max.	2,048; See Operation List	2,048; See Operation List
• Size, max.	16 KByte	64 KByte
FC		
• Number, max.	2,048; See Operation List	2,048; See Operation List
• Size, max.	16 KByte	64 KByte
OB		
• Size, max.	16 KByte	64 KByte
Nesting depth		
• per priority class	8	8
• additional within an error OB	4	4
CPU/processing times		
for bit operations, min.	0.1 µs	0.1 µs
for word operations, min.	0.2 µs	0.1 µs
for fixed point arithmetic, min.	2 µs	0.2 µs
for floating point arithmetic, min.	6 µs	2 µs
Times/counters and their remanence		
S7 counter		
• Number	256	512
• of which remanent without battery		
- adjustable	Yes	Yes
• Counting range		
- lower limit	0	0
- upper limit	999	999
IEC counter		
• present	Yes	Yes
• Type	SFB	SFB
S7 times		
• Number	256	512
• Remanence		
- adjustable	Yes	Yes
- preset	No retentivity	No retentivity
• Time range		
- lower limit	10 ms	10 ms
- upper limit	9,990 s	9,990 s
IEC timer		
• present	Yes	Yes
• Type	SFB	SFB
Data areas and their remanence		
Flag		
• Number, max.	2,048 Byte	4,096 Byte
• Remanence available	Yes; MB 0 to MB 2047	Yes; MB 0 to MB 4095
• Number of clock memories	8; 1 memory byte	8; 1 memory byte

SIMATIC S7-300

SIPLUS central processing units

SIPLUS fail-safe CPUs
4
Technical specifications (continued)

	6AG1 315-6FF01-2AB0	6AG1 317-6FF00-2AB0
Data blocks		
• Number, max.	1,023; DB 0 reserved	2,047; DB 0 reserved
• Size, max.	16 KByte	64 KByte
Local data		
• per priority class, max.	1,024 Byte	1,024 Byte
Address area		
I/O address area		
• Inputs	2 KByte	8 KByte
• Outputs	2 KByte	8 KByte
• of which, distributed		
- Inputs	2 KByte	8 KByte
- Outputs	2 KByte	8 KByte
Process image		
• Inputs	384 Byte	1,024
• Outputs	384 Byte	1,024
Digital channels		
• Inputs	16,384	65,536
• Outputs	16,384	65,536
• Inputs, of which central	1,024	1,024
• Outputs, of which central	1,024	1,024
Analog channels		
• Inputs	1,024	1,024
• Outputs	1,024	1,024
• Inputs, of which central	256	256
• Outputs, of which central	256	256
Hardware config.		
Racks, max.	4	4
Modules per rack, max.	8	8
Number of DP masters		
• integrated	1	2
• via CP	1	2
Number of operable FMs and CPs (recommended)		
• FM	8	8
• CP, point-to-point	8	8
• CP, LAN	10	10
Time		
Clock		
• Hardware clock (real-time clock)	Yes	Yes
• Battery backed and synchronized	Yes	Yes
• Deviation per day, max.	10 s	10 s

	6AG1 315-6FF01-2AB0	6AG1 317-6FF00-2AB0
Operating hours counter		
• Number	1	4
• Number/Number range	0	0 bis 3
• Range of values	0 to 2 ³¹ hours (when using SFC101)	0 to 2 ³¹ hours (when using SFC101)
• Granularity	1 hour	1 hour
• remanent	Yes; must be restarted at each warm restart	Yes; must be restarted at each warm restart
Clock synchronization		
• supports	Yes	Yes
• to MPI, Master	Yes	Yes
• to MPI, Slave	Yes	Yes
• in AS, Master	Yes	Yes
S7 message functions		
Number of login stations for message functions, max.	16; depending on the configured connections for PG/OP and S7 basic communication	32; depending on the configured connections for PG-/ OP- and S7- basic communication
Process diagnostic messages	Yes	Yes
Simultaneously active Alarm-S blocks, max.	40	60
Test commissioning functions		
Status/control		
• Status/control variable	Yes	Yes
• Variables	Inputs, outputs, memory bits, DB, times, counters	Inputs, outputs, memory bits, DB, times, counters
Monitoring functions		
• Number of variables, max.	30	30
• of which status variable, max.	30	30
• of which control variable, max.	14	14
Forcing		
• Forcing	Yes	Yes
• Force, variables	Inputs, outputs	Inputs, outputs
• Forcing, number of variables, max.	10	10
Status block	Yes	Yes
Single step	Yes	Yes
Number of breakpoints	2	2
Diagnostic buffer		
• present	Yes	Yes
• Number of entries, max.	100	100
• adjustable	No	No

SIMATIC S7-300

SIPLUS central processing units

SIPLUS fail-safe CPUs

Technical specifications (continued)

	6AG1 315-6FF01-2AB0	6AG1 317-6FF00-2AB0
Communication functions		
PG/OP communication	Yes	Yes
Routing	Yes	Yes
Global data communication		
• supported	Yes	Yes
• Size of GD packets, max.	22 Byte	22 Byte
S7 basic communication		
• supported	Yes	Yes
S7 communication		
• supported	Yes	Yes
S5-compatible communication		
• supported	Yes; via CP and loadable FC	Yes; via CP and loadable FC
Number of connections		
• overall	16	32
• usable for PG communication	15	31
• usable for OP communication	15	31
• usable for S7 basic communication	13	31
1st interface		
Type of interface	Integral RS 485 interface	Integral RS 485 interface
Physics	RS 485	RS 485
isolated	No	No
Power supply to interface (15 to 30 V DC), max.	200 mA	200 mA
Functionality		
• MPI	Yes	Yes
• DP master	No	Yes
• DP slave	No	No
• Point-to-point coupling	No	No
MPI		
• Number of connections	16	32
• Services		
- PG/OP communication	Yes	Yes
- Routing	Yes	Yes
- Global data communication	Yes	Yes
- S7 basic communication	Yes	Yes
- S7 communication	Yes	Yes
- S7 communication, as client	Yes; via CP and loadable FB	Yes; via CP and loadable FB
- S7 communication, as server	Yes	Yes
• Transmission speeds, max.	187.5 kBit/s	12 Mbit/s

	6AG1 315-6FF01-2AB0	6AG1 317-6FF00-2AB0
DP master		
• Number of connections, max.		32
• Services		
- PG/OP communication		Yes
- Routing		Yes
- Global data communication		No
- S7 basic communication		No
- S7 communication		No
- equidistance support		Yes
- SYNC/FREEZE		Yes
- DPV1		Yes
• Transmission speeds, max.		12 Mbit/s
• Number of DP slaves, max.		125
• Address area		
- Inputs, max.		244 KByte
- Outputs, max.		244 KByte
2nd interface		
Type of interface	Integral RS 485 interface	Integral RS 485 interface
Physics	RS 485	RS 485
isolated	Yes	Yes
Power supply to interface (15 to 30 V DC), max.	200 mA	200 mA
Functionality		
• MPI	No	No
• DP master	Yes	Yes
• DP slave	Yes	Yes
• Point-to-point coupling	No	No
DP master		
• Number of connections, max.	16	32
• Services		
- PG/OP communication	Yes	Yes
- Routing	Yes	Yes
- Global data communication	No	No
- S7 basic communication	No	No
- S7 communication	No	No
- equidistance support	Yes	Yes
- SYNC/FREEZE	Yes	Yes
- DPV1	Yes	Yes
• Transmission speeds, max.	12 Mbit/s	12 Mbit/s
• Number of DP slaves, max.	125	125
• Address area		
- Inputs, max.	244 KByte	244 KByte
- Outputs, max.	244 KByte	244 KByte

SIMATIC S7-300

SIPLUS central processing units

SIPLUS fail-safe CPUs
4
Technical specifications (continued)

	6AG1 315-6FF01-2AB0	6AG1 317-6FF00-2AB0
DP slave		
• Number of connections	16	32
• Services		
- PG/OP communication	Yes	Yes
- Routing	Yes; when interface active	Yes; when interface active
- Global data communication	No	No
- S7 basic communication	No	No
- S7 communication, as client	No	No
- S7 communication, as server	No	No
- direct data exchange (cross traffic)	Yes	Yes
- DPV1	No	No
• GSD file	http://www.ad.siemens.de/csi_e/gsd	http://www.ad.siemens.de/csi_e/gsd
• Transmission speeds, max.	12 Mbit/s	12 Mbit/s
• Transfer memory		
- Inputs	244 Byte	244 Byte
- Outputs	244 Byte	244 Byte
• Address area, max.	32	32
• Useful data per address area, max.	32 Byte	32 Byte
CPU/programming		
Programming language		
• STEP 7	Yes; V5.1 SP6 or higher	Yes; STEP 7 as of V 5.2 + SP1; S7 Distributed Safety as of V5.2 SP1
• LAD	Yes	Yes
• FUP	Yes	Yes
• AWL	Yes	Yes
• SCL	Yes	Yes
Software libraries		
Operational stocks	See Operation List	See Operation List
Nesting levels	8	8
User program protection/password protection	Yes	Yes
System functions (SFC)	See Operation List	See Operation List
System function blocks (SFB)	See Operation List	See Operation List
Dimensions and weight		
Width	40 mm	80 mm
Height	125 mm	125 mm
Depth	130 mm	130 mm
Weights		
Weight, approx.	290 g	560 g

Ordering data
Order No.
SIPLUS CPU 315F-2 DP

(extended temperature range and medial load)

CPU for SIMATIC S7-300F; main memory 192 KB, power supply 24 V DC, MPI/PROFIBUS DP master/slave interface, incl. single location number labels; MMC required

6AG1 315-6FF01-2AB0
SIPLUS CPU 317F-2 DP

(extended temperature range and medial load)

Main memory 512 KB, power supply 24 V DC, MPI, PROFIBUS DP master/slave interface, MMC required

6AG1 317-6FF00-2AB0
Accessories

see S7-300 fail-safe CPUs, page 4/62

SIMATIC S7-300

Digital modules

SM 321 digital input modules

www.DataSheet4U.com

Overview

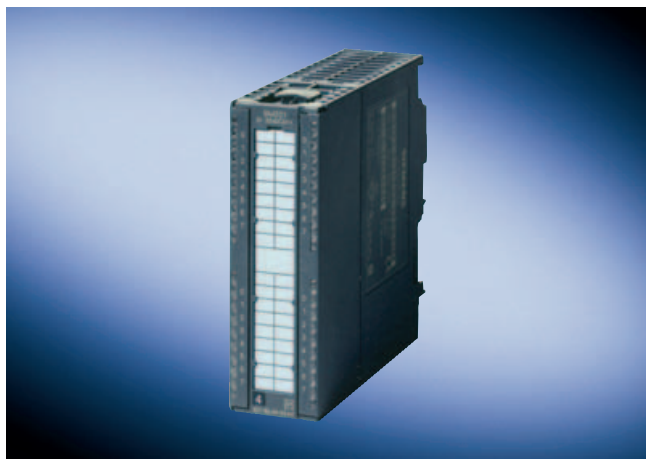

- Digital inputs
- For connecting standard switches and two-wire proximity switches (BERO)

4

Technical specifications

	6ES7 321-1BH02-0AA0	6ES7 321-1BH50-0AA0	6ES7 321-1BL00-0AA0	6ES7 321-1BH10-0AA0
Voltages and currents				
Load voltage L+				
• Rated value (DC)	24 V	24 V	24 V	24 V
Current consumption				
from load voltage L+ (without load), max.	25 mA			
from backplane bus DC 5 V, max.	10 mA	10 mA	15 mA	110 mA
Power loss, typ.	3.5 W	3.5 W	6.5 W	3.8 W
Connection point				
required front connectors	20-pin	20-pin	40-pin	20-pin
Isochronous mode				
Isochronous mode	No	No	No	Yes
Digital inputs				
Number of digital inputs	16	16	32	16
Number of simultaneously controllable inputs				
• vertical installation - up to 40 °C, max.	16	16	32	16
• horizontal installation - up to 40 °C, max. - up to 60 °C, max.	16	16	32 16	16
Cable length				
• Cable length, shielded, max.	1,000 m	1,000 m	1,000 m	1,000 m
• Cable length unshielded, max.	600 m	600 m	600 m	600 m
Input characteristic curve to IEC 1131, type 1	Yes	Yes	Yes	Yes
Input voltage				
• Rated value, DC	24 V	24 V	24 V	24 V
• for signal "0"	-30 V to 5 V	30 V to -5V	-30 to 5 V	-30 V to 5 V
• for signal "1"	13 to 30 V	-13 to -30 V	13 to 30 V	13 to 30 V
Input current				
• for signal "1", typ.	7 mA	7 mA	7 mA	7 mA

www.DataSheet4U.com
 Technical specifications (continued)

	6ES7 321-1BH02-0AA0	6ES7 321-1BH50-0AA0	6ES7 321-1BL00-0AA0	6ES7 321-1BH10-0AA0
Digital inputs				
Input delay (for rated value of input voltage)				
• for standard inputs				
- at "0" to "1", min.	1.2 ms	1.2 ms	1.2 ms	25 µs
- at "0" to "1", max.	4.8 ms	4.8 ms	4.8 ms	75 µs
Encoder				
Connectable encoders				
• 2-wire BEROS	Yes	Yes	Yes	Yes
• permissible quiescent current (2-wire BEROS), max.	1.5 mA	1.5 mA	1.5 mA	1.5 mA
Status information/alarms/diagnostics				
Alarms				
• Alarms	No	No	No	No
Diagnoses				
• Diagnostic functions	No	No	No	No
Diagnostics indication LED				
• Status indicator digital input (green)	Yes	Yes	Yes	Yes
Isolation				
Isolation checked with	500 V DC	500 V DC	500 V DC	500 V DC
Isolation				
Galvanic isolation, digital inputs				
• between the channels			Yes	
• between the channels, in groups of	16	16	16	16
• between the channels and the backplane bus	Yes; Optocoupler	Yes; Optocoupler	Yes; Optocoupler	Yes; Optocoupler
Dimensions and weight				
Width	40 mm	40 mm	40 mm	40 mm
Height	125 mm	125 mm	125 mm	125 mm
Depth	120 mm	120 mm	120 mm	120 mm
Weights				
Weight, approx.	200 g	200 g	260 g	200 g
	6ES7 321-7BH01-0AB0	6ES7 321-1CH00-0AA0	6ES7 321-1CH20-0AA0	6ES7 321-1FH00-0AA0
Voltages and currents				
Load voltage L+				
• Rated value (DC)	24 V	24 V	48 V	
Load voltage L1				
• Rated value (AC)		24 V		230 V; 120/230 V AC; all load voltages must have the same phase.
Current consumption				
from load voltage L+ (without load), max.				
	90 mA			
from backplane bus DC 5 V, max.				
	130 mA	100 mA	40 mA	29 mA
Power loss, typ.				
	4 W	1.5 W	4.3 W	4.9 W
Connection point				
required front connectors	20-pin	40-pin	20-pin	20-pin

SIMATIC S7-300

Digital modules

SM 321 digital input modules

Technical specifications (continued)

	6ES7 321-7BH01-0AB0	6ES7 321-1CH00-0AA0	6ES7 321-1CH20-0AA0	6ES7 321-1FH00-0AA0
Isochronous mode				
Isochronous mode	Yes	No	No	No
Digital inputs				
Number of digital inputs	16	16	16	16
Number of simultaneously controllable inputs				
<ul style="list-style-type: none"> vertical installation - up to 40 °C, max. 	16	16	8	16
<ul style="list-style-type: none"> horizontal installation - up to 50 °C, max. - up to 60 °C, max. 	16	16	8 8; 6 to Ue 146 V	16
Cable length				
<ul style="list-style-type: none"> Cable length, shielded, max. Cable length unshielded, max. 	1,000 m 600 m	1,000 m 600 m	1,000 m 600 m	1,000 m 600 m
Input characteristic curve to IEC 1131, type 1		Yes	Yes	Yes
Input characteristic curve to IEC 1131, type 2	Yes			
Input voltage				
<ul style="list-style-type: none"> Rated value, AC Rated value, DC for signal "0" for signal "1" Frequency range 	24 V -30V to 5 V 13 to 30 V	24 V; AC 24 or 48 V 24 V; DC 24 or 48 V -5 to 5 V AC 14 to 60 V AC 0 to 63 Hz	48 V; DC 48 to 125 V -146 V to 15 V DC 30 to 146 V DC	230 V; 120/230 V AC 0 to 40 V 85 to 264 V 47 to 63 Hz
Input current				
<ul style="list-style-type: none"> for signal "1", typ. 	7 mA	2.7 mA	3.5 mA	8 mA; (120V, 60Hz), 16mA (230V, 50Hz)
Input delay (for rated value of input voltage)				
<ul style="list-style-type: none"> for standard inputs - programmable - at "0" to "1", min. - at "0" to "1", max. 	Yes; 0.1 / 0.5 / 3 / 15 / 20 ms	No 16 ms	0.1 ms 3.5 ms	No 25 ms
Encoder				
Connectable encoders				
<ul style="list-style-type: none"> 2-wire BEROS permissible quiescent current (2-wire BEROS), max. 	Yes 2 mA	Yes 1 mA	Yes 1 mA	Yes 2 mA
Status information/alarms/diagnostics				
Alarms				
<ul style="list-style-type: none"> Alarms Diagnostic alarm Process alarm 	Yes Yes; parameterizable Yes; parameterizable	No No No	No No No	No No No
Diagnoses				
<ul style="list-style-type: none"> Diagnostic functions 	Yes; parameterizable	No	No	No
Diagnostics indication LED				
<ul style="list-style-type: none"> Status indicator digital input (green) 	Yes	Yes	Yes	Yes

www.DataSheet4U.com
Technical specifications (continued)

	6ES7 321-7BH01-0AB0	6ES7 321-1CH00-0AA0	6ES7 321-1CH20-0AA0	6ES7 321-1FH00-0AA0
Isolation				
Isolation checked with	500 V DC	1500 V AC	1500 V DC	4000 V DC
Isolation				
Galvanic isolation, digital inputs				
• between the channels		Yes	Yes	Yes
• between the channels, in groups of	16	1	8	4
• between the channels and the backplane bus	Yes; Optocoupler	Yes; Optocoupler	Yes; Optocoupler	Yes; Optocoupler
Dimensions and weight				
Width	40 mm	40 mm	40 mm	40 mm
Height	125 mm	125 mm	125 mm	125 mm
Depth	120 mm	120 mm	120 mm	120 mm
Weights				
Weight, approx.	200 g	260 g	200 g	240 g
	6ES7 321-1EL00-0AA0	6ES7 321-1FF01-0AA0	6ES7 321-1FF10-0AA0	
Voltages and currents				
Load voltage L1				
• Rated value (AC)	120 V	230 V; 120V/230V AC	230 V; 120/230 V AC; all load voltages must have the same phase.	
Current consumption				
from backplane bus DC 5 V, max.	16 mA	29 mA	100 mA	
Power loss, typ.	4 W	4.9 W	4.9 W	
Connection point				
required front connectors	40-pin	20-pin	40-pin	
Isochronous mode				
Isochronous mode	No	No	No	
Digital inputs				
Number of digital inputs	32	8	8	
Number of simultaneously controllable inputs				
• vertical installation - up to 40 °C, max.	32	8	8	
• horizontal installation - up to 40 °C, max.	32			
- up to 60 °C, max.	24	8	8	
Cable length				
• Cable length, shielded, max.	1,000 m	1,000 m	1,000 m	
• Cable length unshielded, max.	600 m	600 m	600 m	
Input characteristic curve to IEC 1131, type 1		Yes	Yes	
Input characteristic curve to IEC 1131, type 2	Yes			
Input voltage				
• Rated value, AC	120 V	230 V; 120/230 V AC	120 V; 120/230 V AC	
• for signal "0"	0 to 20 V	0 to 40 V	0 to 40 V	
• for signal "1"	74 to 132 V	85 to 264 V	85 to 264 V	
• Frequency range	47 to 63 Hz	47 to 63 Hz	47 to 63 Hz	

SIMATIC S7-300

Digital modules

SM 321 digital input modules

Technical specifications (continued)

	6ES7 321-1EL00-0AA0	6ES7 321-1FF01-0AA0	6ES7 321-1FF10-0AA0
Input current			
• for signal "1", typ.	21 mA	6.5 mA; (120 V); 11mA (230 V)	7.5 mA; (120 V); 17.3 mA (230 V)
Input delay (for rated value of input voltage)			
• for standard inputs	No	No	No
- programmable			
- at "0" to "1", max.	15 ms	25 ms	25 ms
Encoder			
Connectable encoders			
• 2-wire BERS	Yes	Yes	Yes
• permissible quiescent current (2-wire BERS), max.	4 mA	2 mA	2 mA
Status information/alarms/diagnostics			
Alarms			
• Alarms	No	No	No
• Diagnostic alarm	No	No	No
• Process alarm	No	No	No
Diagnoses			
• Diagnostic functions	No	No	No
Diagnostics indication LED			
• Status indicator digital input (green)	Yes	Yes	Yes
Isolation			
Isolation checked with	2500 V DC	4000 V DC	1500 V AC
Isolation			
Galvanic isolation, digital inputs			
• between the channels	Yes	Yes	Yes
• between the channels, in groups of	8	2	1
• between the channels and the backplane bus	Yes; Optocoupler	Yes; Optocoupler	Yes; Optocoupler
Dimensions and weight			
Width	40 mm	40 mm	40 mm
Height	125 mm	125 mm	125 mm
Depth	120 mm	120 mm	120 mm
Weights			
Weight, approx.	300 g	240 g	240 g

Ordering data	Order No.	Order No.
SM 321 digital input modules		
incl. labeling strips, bus connector		
16 inputs, 24 V DC	6ES7 321-1BH02-0AA0	
16 inputs, 24 V DC, active low	6ES7 321-1BH50-0AA0	
32 inputs, 24 V DC	6ES7 321-1BL00-0AA0	
16 inputs, 24 ... 48 V DC	A) 6ES7 321-1CH00-0AA0	
16 inputs, 48 ... 125 V DC	A) 6ES7 321-1CH20-0AA0	
16 inputs, 24 V DC, for isochronous mode	6ES7 321-1BH10-0AA0	
32 inputs, 120 V AC	A) 6ES7 321-1EL00-0AA0	
8 inputs, 120/230 V AC	A) 6ES7 321-1FF01-0AA0	
8 inputs, 120/230 V AC, single root	A) 6ES7 321-1FF10-0AA0	
16 inputs, 120/230 V AC	A) 6ES7 321-1FH00-0AA0	
16 inputs, 24 V DC, for isochronous mode, diagnostics-capable	6ES7 321-7BH01-0AB0	
Front connectors		
20-pin, with screw contacts		
• 1 unit	6ES7 392-1AJ00-0AA0	
• 100 units	6ES7 392-1AJ00-1AB0	
20-pin, with cage clamp contacts		
• 1 unit	6ES7 392-1BJ00-0AA0	
• 100 units	6ES7 392-1BJ00-1AB0	
40-pin, with screw contacts		
• 1 unit	6ES7 392-1AM00-0AA0	
• 100 units	6ES7 392-1AM00-1AB0	
40-pin with cage clamp contacts		
• 1 unit	6ES7 392-1BM01-0AA0	
• 100 units	6ES7 392-1BM01-1AB0	
SIMATIC TOP connect	See page 4/225; Information about which components can be used for the respective module, see A&D Mall or Catalog KT 10.2	
Bus connectors	6ES7 390-0AA00-0AA0	
1 unit (spare part)		
Labeling strips		
10 units (spare part)		
for modules with 20-pin front connector	6ES7 392-2XX00-0AA0	
for modules with 40-pin front connector	6ES7 392-2XX10-0AA0	
Label cover		
10 units (spare part)		
for modules with 20-pin front connector	6ES7 392-2XY00-0AA0	
for modules with 40-pin front connector	6ES7 392-2XY10-0AA0	
	S7 SmartLabel	
	Software for automatic labeling of modules based on data of the STEP 7 project	2XV9 450-1SL01-0YX0
	Labeling sheets for machine inscription	
	for 16-channel signal modules, DIN A4, for printing with laser printer; 10 units	
	petrol	6ES7 392-2AX00-0AA0
	light-beige	6ES7 392-2BX00-0AA0
	yellow	6ES7 392-2CX00-0AA0
	red	6ES7 392-2DX00-0AA0
	for 32-channel signal modules, DIN A4, for printing with laser printer; 10 units	
	petrol	6ES7 392-2AX10-0AA0
	light-beige	6ES7 392-2BX10-0AA0
	yellow	6ES7 392-2CX10-0AA0
	red	6ES7 392-2DX10-0AA0
	SIMATIC Manual Collection D)	6ES7 998-8XC01-8YE0
	Electronic manuals on DVD, multilingual: S7-200, S7-300, C7, S7-400, SIMATIC DP (Distributed I/O), SIMATIC PC, SIMATIC PG, STEP 7, Engineering Tools, Runtime Software, SIMATIC PCS 7, SIMATIC HMI (Human Machine Interface), SIMATIC NET (Industrial Communication), SIMATIC Machine Vision, SIMATIC Sensors	
	SIMATIC Manual Collection update service for 1 year D)	6ES7 998-8XC01-8YE2
	Current S7 Manual Collection DVD and the three subsequent updates	
	S7-300 manual	
	Design, CPU data, module data, instruction list	
	German	6ES7 398-8FA10-8AA0
	English	6ES7 398-8FA10-8BA0
	French	6ES7 398-8FA10-8CA0
	Spanish	6ES7 398-8FA10-8DA0
	Italian	6ES7 398-8FA10-8EA0

A) Subject to export regulations: AL: N and ECCN: EAR99H

D) Subject to export regulations: AL: N and ECCN: 5D992B1

SIMATIC S7-300

Digital modules

SM 322 digital output modules

www.DataSheet4U.com

Overview

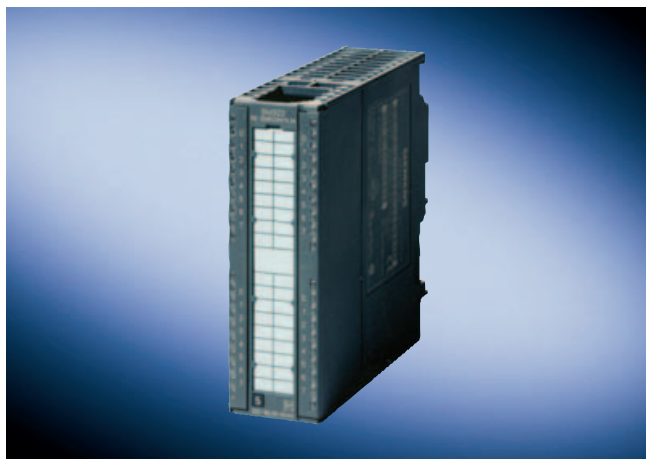

- Digital outputs
- For connecting solenoid valves, contactors, low-power motors, lamps and motor starters

4

Technical specifications

	6ES7 322-1BH01-0AA0	6ES7 322-1BH10-0AA0	6ES7 322-1BL00-0AA0	6ES7 322-8BF00-0AB0	6ES7 322-5GH00-0AB0	6ES7 322-1CF00-0AA0
Voltages and currents						
Load voltage L+						
• Rated value (DC)	24 V	24 V	24 V	24 V	24 V; 24/48	48 V; 48 to 125 V DC
Current consumption						
from load voltage L+ (without load), max.	80 mA	110 mA	160 mA	90 mA	200 mA	2 mA
from backplane bus DC 5 V, max.	80 mA	70 mA	110 mA	70 mA	100 mA	100 mA
Power loss, typ.	4.9 W	5 W	6.6 W	5 W	2.8 W	7.2 W
Connection point						
required front connectors	20-pin	20-pin	40-pin	20-pin	40-pin	20-pin
Digital outputs						
Number of digital outputs	16	16	32	8	16	8
Cable length, shielded, max.	1,000 m	1,000 m	1,000 m	1,000 m	1,000 m	1,000 m
Cable length unshielded, max.	600 m	600 m	600 m	600 m	600 m	600 m
Short-circuit protection of the output	Yes; electronic	Yes; electronic	Yes; electronic	Yes; electronic	No; to be provided externally	Yes; electronic
Limitation of inductive shutdown voltage to	L+ (-53 V)	L+ (-53 V)	L+ (-53 V)	L+ (-45 V)		M (-1V)
Lamp load, max.	5 W	5 W	5 W	5 W	2.5 W	15 W; 15 W (48 V) or 40 W (125 V)
Output voltage						
• for signal "1", min.	L+ (-0.8 V)	L+ (-0.8 V)	L+ (-0.8 V)	L+ (-0.8 V to -1.6 V)	L+ (-0.25 V)	L+ (-1.2 V)
Output current						
• for signal "1" rated value	0.5 A	0.5 A	0.5 A	0.5 A	0.5 A	1.5 A
• for signal "1" permissible range for 0 to 40 °C, min.	5 mA	5 mA	5 mA	10 mA		10 mA
• for signal "1" permissible range for 0 to 40 °C, max.	0.6 A	0.6 A	0.6 A	0.6 A		1.5 A
• for signal "1" permissible range for 40 to 60 °C, min.	5 mA	5 mA	5 mA	10 mA		10 mA
• for signal "1" permissible range for 40 to 60 °C, max.	0.6 A	0.6 A	0.6 A	0.6 A		1.5 A

SIMATIC S7-300

Digital modules

SM 322 digital output modules

Technical specifications (continued)

	6ES7 322-1BF01-0AA0	6ES7 322-1FF01-0AA0	6ES7 322-5FF00-0AB0	6ES7 322-1FH00-0AA0	6ES7 322-1FL00-0AA0	6ES7 322-1HF01-0AA0
Current consumption						
from load voltage L+ (without load), max.	60 mA			2 mA		110 mA; Current consumption of relay
from load voltage L1 (without load), max.		2 mA	2 mA	3 mA	10 mA	110 mA
from backplane bus DC 5 V, max.	40 mA	100 mA	100 mA	200 mA	190 mA	40 mA
Power loss, typ.	6.8 W	8.6 W	8.6 W	8.6 W	25 W	3.2 W
Connection point						
required front connectors	20-pin	20-pin	40-pin	20-pin	20-pin	20-pin
Digital outputs						
Number of digital outputs	8	8	8	16	32	8; Relay
Cable length, shielded, max.	1,000 m	1,000 m	1,000 m	1,000 m	1,000 m	1,000 m
Cable length unshielded, max.	600 m	600 m	600 m	600 m	600 m	600 m
Short-circuit protection of the output	Yes; electronic	Yes; Fuse, 8 A / 250 V: per group	Yes; to be provided externally; fuse 3,15 A / 250 V, quick response	Yes; Fuse 8A, 250 V; per group	No	
Limitation of inductive shutdown voltage to	L+ (-48 V)					
Lamp load, max.	10 W	50 W	50 W	50 W	50 W	50 W
Output voltage						
• for signal "1", min.	L+ (-0.8 V)	L1 (-1.5 V)	L1 (-8.5 V)	L+(-0.8 V)	L1 (-0.8 V)	
Output current						
• for signal "1" rated value	2 A	2 A	2 A	1 A	1 A	
• for signal "1" permissible range for 0 to 40 °C, min.	5 mA	10 mA	10 mA	10 mA	10 mA	
• for signal "1" permissible range for 0 to 40 °C, max.	2.4 A	2 A	2 A	1 A	1 A	
• for signal "1" permissible range for 40 to 60 °C, min.	5 mA	10 mA	10 mA	10 mA	10 mA	
• for signal "1" permissible range for 40 to 60 °C, max.	2.4 A	1 A	1 A	0.5 A	1 A	
• for signal "1" minimum load current	5 mA	10 mA	10 mA	10 mA	10 mA	5 mA
• for signal "1" permissible peak current, max.		20 A; max. 1 AC cycle	20 A; with 2 half waves	20 A; with 2 half waves	10 A; per group (for 2 AC cycles)	
• for signal "0" residual current, max.	0.5 mA	2 mA	2 mA	2 mA	2 mA	
Switching frequency						
• with resistive load, max.	100 Hz	10 Hz	10 Hz	10 Hz	10 Hz	2 Hz
• with inductive load, max.	0.5 Hz	0.5 Hz	0.5 Hz	0.5 Hz	0.5 Hz	0.5 Hz
• on lamp load, max.	10 Hz	1 Hz	1 Hz	1 Hz	1 Hz	2 Hz
• mechanical, max.						10 Hz
Aggregate current of the outputs (per group)						
• vertical installation - up to 40 °C, max.	4 A	2 A	4 A	2 A	4 A	

SIMATIC S7-300

Digital modules

SM 322 digital output modules

4

Technical specifications (continued)

	6ES7 322-1BF01-0AA0	6ES7 322-1FF01-0AA0	6ES7 322-5FF00-0AB0	6ES7 322-1FH00-0AA0	6ES7 322-1FL00-0AA0	6ES7 322-1HF01-0AA0
Aggregate current of the outputs (per group)						
• horizontal installation		4 A	8 A	4 A	4 A	
- up to 40 °C, max.						
- up to 60 °C, max.	4 A	2 A	4 A	2 A	3 A	
Relay outputs						
Rated input voltage of relay L+ (DC)						24 V; 110 mA
Number of operating cycles						300,000; 230 V AC: 100000, 120 V AC: 200000, 24 V DC: 300000 (at 2 A)
Switching capacity of the contacts						
• with inductive load, max.						2 A; 2 A (230 V AC), 2 A (24 V DC)
• with resistive load, max.						2 A
Status information/alarms/diagnostics						
Alarms						
• Diagnostic alarm	No	No	Yes; parameterizable	No	No	No
Diagnoses						
• Diagnostics	No	Yes	Yes; Off / last value / substitute value	Yes	Yes	No
Isolation						
Isolation checked with	500 V DC	1500 V AC	1500 V AC	4000 V DC	4000 V DC	1500 V AC
Isolation						
Isolation, digital outputs						
• between the channels, in groups of	4	4	1	8	8	2
• between the channels and the backplane bus	Yes; Optocoupler	Yes; Optocoupler	Yes; Optocoupler	Yes; Optocoupler	Yes; Optocoupler	Yes; Optocoupler
Dimensions and weight						
Width	40 mm	40 mm	40 mm	40 mm	80 mm	40 mm
Height	125 mm	125 mm	125 mm	125 mm	125 mm	125 mm
Depth	120 mm	120 mm	120 mm	120 mm	117 mm	120 mm
Weights						
Weight, approx.	190 g	275 g	275 g	275 g	500 g	190 g
		6ES7 322-1HF10-0AA0	6ES7 322-5HF00-0AB0	6ES7 322-1HH01-0AA0		
Voltages and currents						
Load voltage L+						
• Rated value (DC)	120 V		24 V		120 V	
Load voltage L1						
• Rated value (AC)	230 V		230 V		230 V	
Current consumption						
from backplane bus DC 5 V, max.	40 mA		100 mA		100 mA	
Power loss, typ.	4.2 W		3.5 W		4.5 W	
Connection point						
required front connectors	40-pin		40-pin		20-pin	

SIMATIC S7-300

Digital modules

SM 322 digital output modules

Technical specifications (continued)

	6ES7 322-1HF10-0AA0	6ES7 322-5HF00-0AB0	6ES7 322-1HH01-0AA0
Digital outputs			
Number of digital outputs	8; Relay	8; Relay	16; Relay
Cable length, shielded, max.	1,000 m	1,000 m	1,000 m
Cable length unshielded, max.	600 m	600 m	600 m
Short-circuit protection of the output	No; to be provided externally	No; to be provided externally	
Lamp load, max.	1,500 W; AC 230 V	1,500 W; AC 230 V	50 W; AC 230 V
Output current			
• for signal "1" minimum load current	5 mA	10 mA	10 mA
Switching frequency			
• with resistive load, max.	2 Hz	2 Hz	1 Hz
• with inductive load, max.	0.5 Hz	0.5 Hz	0.5 Hz
• on lamp load, max.	2 Hz	2 Hz	1 Hz
• mechanical, max.	10 Hz	10 Hz	10 Hz
Aggregate current of the outputs (per group)			
• vertical installation - up to 40 °C, max.	5 A	5 A	8 A
• horizontal installation - up to 60 °C, max.	5 A	5 A	8 A
Relay outputs			
Rated input voltage of relay L+ (DC)	24 V		24 V
Number of operating cycles	300,000; 300,000 (DC 24 V, at 2 A), 200,000 (AC 120 V, at 3 A), 100,000 (AC 230 V, at 3 A)	100,000; 100,000 (DC 24 V, at 5 A), 100,000 (AC 230 V, at 5 A)	100,000; 50,000 (24 V DC, at 2 A), 700,000 (120 V AC, at 2 A), 100,000 (230 V AC, at 2 A)
Switching capacity of the contacts			
• with inductive load, max.	3 A; 3 A (230 V AC), 2 A (24 V DC)	5 A; 5 A (230 V AC), 5 A (24 V DC)	2 A; 2 A (230 V AC), 2 A (24 V DC)
• with resistive load, max.	8 A; 8 A (230 V AC), 5 A (24 V DC)	5 A; 5 A (230 V AC), 5 A (24 V DC)	2 A; 2 A (230 V AC), 2 A (24 V DC)
Status information/ alarms/diagnostics			
Alarms			
• Diagnostic alarm	No	Yes; parameterizable	No
Diagnoses			
• Diagnostics	No	Yes; Off / last value / substitute value	No
Isolation			
Isolation checked with	2000 V AC	1500 V AC	1500 V AC
Isolation			
Isolation, digital outputs			
• between the channels, in groups of	1	1	8
• between the channels and the backplane bus	Yes; Optocoupler	Yes; Optocoupler	Yes; Optocoupler
Dimensions and weight			
Width	40 mm	40 mm	40 mm
Height	125 mm	125 mm	125 mm
Depth	120 mm	120 mm	120 mm
Weights			
Weight, approx.	320 g	320 g	250 g

Ordering data	Order No.	Order No.
SM 322 digital output modules		
incl. labeling strips, bus connector		
8 outputs, 24 V DC, 2 A	6ES7 322-1BF01-0AA0	
16 outputs, 24 V DC, 0.5 A	6ES7 322-1BH01-0AA0	
16 outputs, 24 V DC, 0.5 A, high speed	6ES7 322-1BH10-0AA0	
32 outputs, 24 V DC, 0.5 A	6ES7 322-1BL00-0AA0	
8 outputs, 24 V DC, 0.5 A, diagnostics-capable	6ES7 322-8BF00-0AB0	
16 outputs, 24/48 V DC, 0.5 A A)	6ES7 322-5GH00-0AB0	
8 outputs, 48 to 125 V DC, 1.5 A A)	6ES7 322-1CF00-0AA0	
8 outputs, 120/230 V AC, 1 A A)	6ES7 322-1FF01-0AA0	
8 outputs, 120/230 V AC, 2 A A)	6ES7 322-5FF00-0AB0	
16 outputs, 120/230 V AC, 1 A A)	6ES7 322-1FH00-0AA0	
32 outputs, 120 V AC, 1 A A)	6ES7 322-1FL00-0AA0	
8 outputs, relay contacts, 2 A	6ES7 322-1HF01-0AA0	
8 outputs, relay contacts, 5 A	6ES7 322-1HF10-0AA0	
8 outputs, relay contacts, 5 A, with RC filter, overvoltage protection A)	6ES7 322-5HF00-0AB0	
16 outputs, relay contacts, 8 A	6ES7 322-1HH01-0AA0	
Front connectors		
20-pin, with screw contacts		
• 1 unit	6ES7 392-1AJ00-0AA0	
• 100 units	6ES7 392-1AJ00-1AB0	
20-pin, with cage clamp contacts		
• 1 unit	6ES7 392-1BJ00-0AA0	
• 100 units	6ES7 392-1BJ00-1AB0	
40-pin, with screw contacts		
• 1 unit	6ES7 392-1AM00-0AA0	
• 100 units	6ES7 392-1AM00-1AB0	
40-pin with cage clamp contacts		
• 1 unit	6ES7 392-1BM01-0AA0	
• 100 units	6ES7 392-1BM01-1AB0	
Front door, elevated design A)	6ES7 328-0AA00-7AA0	
e.g. for 32-channel modules; for connecting 1.3 mm ² /16 AWG conductors		
SIMATIC TOP connect	See page 4/225; Information about which components can be used for the respective module, see A&D Mall or Catalog KT 10.2	
Bus connectors	6ES7 390-0AA00-0AA0	
1 unit (spare part)		
Set of fuses for SM 322		
10 fuses 8 A quick-response, 2 fuse holders; for 6ES7 322-1FF01-0AA0, 6ES7 322-1FH00-0AA0 A)	6ES7 973-1HD00-0AA0	
10 fuses 6.3 A; for 6ES7 322-1CF00-0AA0	6ES7 973-1GC00-0AA0	
Labeling strips		
10 units (spare part)		
for modules with 20-pin front connector	6ES7 392-2XX00-0AA0	
for modules with 40-pin front connector	6ES7 392-2XX10-0AA0	
Label cover		
10 units (spare part)		
for modules with 20-pin front connector	6ES7 392-2XY00-0AA0	
for modules with 40-pin front connector	6ES7 392-2XY10-0AA0	
S7 SmartLabel		
Software for automatic labeling of modules based on data of the STEP 7 project	2XV9 450-1SL01-0YX0	
Labeling sheets for machine inscription		
For 16-channel signal modules, DIN A4, for printing with laser printer; 10 units		
petrol	6ES7 392-2AX00-0AA0	
light-beige	6ES7 392-2BX00-0AA0	
yellow	6ES7 392-2CX00-0AA0	
red	6ES7 392-2DX00-0AA0	
For 32-channel signal modules, DIN A4, for printing with laser printer; 10 units		
petrol	6ES7 392-2AX10-0AA0	
light-beige	6ES7 392-2BX10-0AA0	
yellow	6ES7 392-2CX10-0AA0	
red	6ES7 392-2DX10-0AA0	
SIMATIC Manual Collection D)	6ES7 998-8XC01-8YE0	
Electronic manuals on DVD, multilingual: S7-200, S7-300, C7, S7-400, SIMATIC DP (Distributed I/O), SIMATIC PC, SIMATIC PG (Programming device), STEP 7, Engineering Tools, Runtime Software, SIMATIC PCS 7, SIMATIC HMI (Human Machine Interface), SIMATIC NET (Industrial Communication), SIMATIC Machine Vision, SIMATIC Sensors		
SIMATIC Manual Collection update service for 1 year D)	6ES7 998-8XC01-8YE2	
Current S7 Manual Collection DVD and the three subsequent updates		
S7-300 manual		
Design, CPU data, module data, instruction list		
German	6ES7 398-8FA10-8AA0	
English	6ES7 398-8FA10-8BA0	
French	6ES7 398-8FA10-8CA0	
Spanish	6ES7 398-8FA10-8DA0	
Italian	6ES7 398-8FA10-8EA0	

A) Subject to export regulations: AL: N and ECCN: EAR99H

D) Subject to export regulations: AL: N and ECCN: 5D992B1

SIMATIC S7-300

Digital modules

SM 323/SM 327 digital input/output modules

www.DataSheet4U.com

Overview

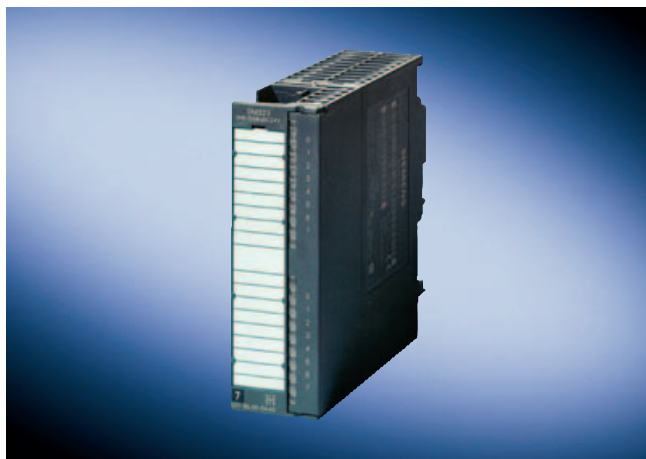

- Digital inputs and outputs
- For connecting standard switches, two-wire proximity switches (BERO), solenoid valves, contactors, low-power motors, lamps and motor starters

Technical specifications

	6ES7 323-1BH01-0AA0	6ES7 323-1BL00-0AA0	6ES7 327-1BH00-0AB0
Voltages and currents			
Load voltage L+			
• Rated value (DC)	24 V	24 V	24 V
Current consumption			
from load voltage L+ (without load), max.	40 mA	80 mA	20 mA
from backplane bus DC 5 V, max.	40 mA	80 mA	60 mA
Power loss, typ.	3.5 W	6.5 W	3 W
Connection point			
required front connectors	20-pin	40-pin	20-pin
Isochronous mode			
Isochronous mode	No	No	No
Digital inputs			
Number of digital inputs	8	16	8; 8 hardwired, and 8 others individually parameterizable
Number of simultaneously controllable inputs			
• Number of simultaneously controllable inputs, up to 40 °C	8	16	16
• Number of simultaneously controllable inputs, up to 60 °C	8	8	16
Cable length			
• Cable length, shielded, max.	1,000 m	1,000 m	1,000 m
• Cable length unshielded, max.	600 m	600 m	600 m
Input characteristic curve to IEC 1131, type 1	Yes	Yes	Yes
Input voltage			
• Rated value, DC	24 V	24 V	24 V
• for signal "0"	-30V to 5 V	-30V to 5 V	-30V to 5 V
• for signal "1"	13 to 30 V	13 to 30 V	15 to 30 V
Input current			
• for signal "1", typ.	7 mA	7 mA	6 mA

www.DataSheet4U.com
Technical specifications (continued)

	6ES7 323-1BH01-0AA0	6ES7 323-1BL00-0AA0	6ES7 327-1BH00-0AB0
Input delay (for rated value of input voltage)			
• for standard inputs			
- at "0" to "1", min.	1.2 ms	1.2 ms	1.2 ms
- at "0" to "1", max.	4.8 ms	4.8 ms	4.8 ms
- at "1" to "0", min.	1.2 ms	1.2 ms	1.2 ms
- at "1" to "0", max.	4.8 ms	4.8 ms	4.8 ms
Digital outputs			
Number of digital outputs	8	16	8; can also be parameterized individually as DI
Cable length, shielded, max.	1,000 m	1,000 m	1,000 m
Cable length unshielded, max.	600 m	600 m	600 m
Short-circuit protection of the output	Yes; electronic	Yes; electronic	Yes; electronic
• Response threshold, typ.	1 A	1 A	1A
Limitation of inductive shutdown voltage to	L+ (-53 V)	L+ (-48 V)	L+ (-54 V)
Lamp load, max.	5 W	5 W	5 W
Controlling a digital input	Yes	Yes	Yes
Output voltage			
• for signal "1", min.	L+ (-0.8 V)	L+ (-0.8 V)	L+ (-1.5 V)
Output current			
• for signal "1" rated value	0.5 A	0.5 A	0.5 A
• for signal "1" permissible range for 0 to 60 °C, min.			5 mA
• for signal "1" permissible range for 0 to 60 °C, max.			0.6 A
• for signal "1" minimum load current	5 mA	5 mA	
• for signal "0" residual current, max.	0.5 mA	0.5 mA	0.5 mA
Output delay with resistive load			
• "0" to "1", max.	100 µs	100 µs	350 µs
• "1" to "0", max.	500 µs	500 µs	500 µs
Parallel switching of 2 outputs			
• for increased power	No	No	No
• for redundant control of a load	Yes; Outputs of the same group only	Yes; Outputs of the same group only	Yes; only outputs of the same group
Switching frequency			
• with resistive load, max.	100 Hz	100 Hz	100 Hz
• with inductive load, max.	0.5 Hz	0.5 Hz	0.5 Hz
• on lamp load, max.	10 Hz	100 Hz	10 Hz
Aggregate current of the outputs (per group)			
• vertical installation			
- up to 40 °C, max.	4 A	2 A	2 A
• horizontal installation			
- up to 40 °C, max.		4 A	4 A
- up to 60 °C, max.	4 A	3 A	3 A

SIMATIC S7-300

Digital modules

SM 323/SM 327 digital input/output modules

Technical specifications (continued)

	6ES7 323-1BH01-0AA0	6ES7 323-1BL00-0AA0	6ES7 327-1BH00-0AB0
Digital outputs			
Load impedance range			
• lower limit	48 Ω	48 Ω	48 Ω
• upper limit	4 kΩ	4 kΩ	4 kΩ
Encoder			
Connectable encoders			
• 2-wire BERS	Yes	Yes	Yes
• permissible quiescent current (2-wire BERS), max.	2 mA	1.5 mA	1.5 mA
Status information/alarms/diagnostics			
Alarms			
• Alarms	No	No	No
Diagnoses			
• Diagnostic functions	No	No	No
Diagnostics indication LED			
• Status indicator digital output (green)	Yes	Yes	Yes
• Status indicator digital input (green)	Yes	Yes	Yes
Isolation			
Isolation checked with	500 V DC	500 V DC	500 V DC
Isolation			
Isolation, digital outputs			
• between the channels	Yes	Yes	No
• between the channels, in groups of	8	8	
• between the channels and the backplane bus	Yes; Optocoupler	Yes; Optocoupler	Yes; Optocoupler
Galvanic isolation, digital inputs			
• between the channels	Yes	Yes	No
• between the channels, in groups of	8	16	
• between the channels and the backplane bus	Yes; Optocoupler	Yes; Optocoupler	Yes; Optocoupler
Permissible potential difference			
between different circuits	500 V DC	500 V DC	500 V DC
Dimensions and weight			
Width	40 mm	40 mm	40 mm
Height	125 mm	125 mm	125 mm
Depth	120 mm	120 mm	120 mm
Weights			
Weight, approx.	220 g	260 g	200 g

SIMATIC S7-300

Digital modules

SM 323/SM 327 digital input/output modules

Ordering data	Order No.	Order No.
SM 323 digital input/output modules incl. labeling strips, bus connector 8 inputs, 8 outputs 16 inputs, 16 outputs	6ES7 323-1BH01-0AA0 6ES7 323-1BL00-0AA0	S7 SmartLabel Software for automatic labeling of modules based on data of the STEP 7 project 2XV9 450-1SL01-0YX0
SM 327 digital input/output modules incl. labeling strips, bus connector 8 inputs, 8 inputs or outputs (can be configured)	6ES7 327-1BH00-0AB0	Labeling sheets for machine inscription For 16-channel signal modules, DIN A4, for printing with laser printer; 10 units petrol 6ES7 392-2AX00-0AA0 light-beige 6ES7 392-2BX00-0AA0 yellow 6ES7 392-2CX00-0AA0 red 6ES7 392-2DX00-0AA0 For 32-channel signal modules, DIN A4, for printing with laser printer; 10 units petrol 6ES7 392-2AX10-0AA0 light-beige 6ES7 392-2BX10-0AA0 yellow 6ES7 392-2CX10-0AA0 red 6ES7 392-2DX10-0AA0
Front connectors 20-pin, with screw contacts • 1 unit 6ES7 392-1AJ00-0AA0 • 100 units 6ES7 392-1AJ00-1AB0 20-pin, with cage clamp contacts • 1 unit 6ES7 392-1BJ00-0AA0 • 100 units 6ES7 392-1BJ00-1AB0 40-pin, with screw contacts • 1 unit 6ES7 392-1AM00-0AA0 • 100 units 6ES7 392-1AM00-1AB0 40-pin with cage clamp contacts • 1 unit 6ES7 392-1BM01-0AA0 • 100 units 6ES7 392-1BM01-1AB0		SIMATIC Manual Collection D) 6ES7 998-8XC01-8YE0 Electronic manuals on DVD, multilingual: S7-200, S7-300, C7, S7-400, SIMATIC DP (Distributed I/O), SIMATIC PC, SIMATIC PG (Programming device), STEP 7, Engineering Tools, Runtime Software, SIMATIC PCS 7, SIMATIC HMI (Human Machine Interface), SIMATIC NET (Industrial Communication), SIMATIC Machine Vision, SIMATIC Sensors
Front door, elevated design A) 6ES7 328-0AA00-7AA0 e.g. for 32 channel modules; enables connection of 1.3 mm ² /16 AWG wires		SIMATIC Manual Collection update service for 1 year D) 6ES7 998-8XC01-8YE2 Current S7 Manual Collection DVD and the three subsequent updates
SIMATIC TOP connect See page 4/225; Information about which components can be used for the respective module, see A&D Mall or Catalog KT 10.2		S7-300 manual Design, CPU data, module data, instruction list German 6ES7 398-8FA10-8AA0 English 6ES7 398-8FA10-8BA0 French 6ES7 398-8FA10-8CA0 Spanish 6ES7 398-8FA10-8DA0 Italian 6ES7 398-8FA10-8EA0
Bus connectors 6ES7 390-0AA00-0AA0 1 unit (spare part)		
Labeling strips 10 units (spare part) for modules with 20-pin front connector 6ES7 392-2XX00-0AA0 for modules with 40-pin front connector 6ES7 392-2XX10-0AA0		
Label cover 10 units (spare part) for modules with 20-pin front connector 6ES7 392-2XY00-0AA0 for modules with 40-pin front connector 6ES7 392-2XY10-0AA0		

A) Subject to export regulations: AL: N and ECCN: EAR99H

D) Subject to export regulations: AL: N and ECCN: 5D992B1

www.DataSheet4U.com
Overview

- Digital outputs
- For connecting solenoid valves, contactors, low-power motors, lamps and motor starters

SIPLUS SM 322	16 DO	8 DO	8 DO	16 DO – 48 ... 125 V DC
Order No.	6AG1 322-1BH01-2AA0	6AG1 322-1BF01-2XB0	6AG1 322-8BF00-2AB0	6AG1 322-1CF00-2AA0
Order No. based on	6ES7 322-1BH01-0AA0	6ES7 322-1BF01-0AA0	6ES7 322-8BF00-0AB0	6ES7 322-1CF00-0AA0
Ambient temperature range	-25 °C to +60 °C, condensation permissible			
Ambient conditions	Suitable for extraordinary medial load (for example by chloric and sulphuric atmospheres).			
Conformity with standard for electronic devices on rail vehicles (EN 50155, temperature T1, category 1)	Yes	Yes	Yes	Yes
Technical data	The technical data are identical with the technical data of the based on modules.			

SIPLUS SM 322	8 DO – 120/230 V AC	8 RO	32 DO	16 RO
Order No.	6AG1 322-1FF01-2AA0	6AG1 322-1HF10-2AA0	6AG1 322-1BL00-2AA0	6AG1 322-1HH01-2AA0
Order No. based on	6ES7 322-1FF01-0AA0	6ES7 322-1HF10-0AA0	6ES7 322-1BL00-0AA0	6ES7 322-1HH01-0AA0
Ambient temperature range	-25 °C to +60 °C, condensation permissible			
Ambient conditions	Suitable for extraordinary medial load (for example by chloric and sulphuric atmospheres).			
Conformity with standard for electronic devices on rail vehicles (EN 50155, temperature T1, category 1)	Yes	Yes	Yes	Yes
Technical data	The technical data are identical with the technical data of the based on modules.			

Ordering data**Digital output modules
SIPLUS SM 322**

(extended temperature range and medial load)

incl. labeling strips, bus connector

16 outputs, 24 V DC, 0.5 A	A) 6AG1 322-1BH01-2AA0
8 outputs, 24 V DC, 2 A	A) 6AG1 322-1BF01-2XB0
8 outputs, 24 V DC, 0.5 A, diagnostics-capable	A) 6AG1 322-8BF00-2AB0
8 outputs, 48 to 125 V DC, 1.5 A	A) 6AG1 322-1CF00-2AA0

**Digital output modules
SIPLUS SM 322**

(extended temperature range and medial load)

incl. labeling strips, bus connector

8 outputs, 120/230 V AC, 1 A	A) 6AG1 322-1FF01-2AA0
8 outputs, relay contacts, 5 A	6ES7 322-1HF10-0AA0
32 outputs, 24 V DC, 0.5 A	6AG1 322-1BL00-2AA0
16 outputs, relay contacts, 8 A	6AG1 322-1HH01-2AA0

Accessories

see S7-300 digital output modules, page 4/103

A) Subject to export regulations: AL: N and ECCN: EAR99H

SIMATIC S7-300

SIPLUS digital modules

SIPLUS SM 323 digital input/output modules

www.DataSheet4U.com

Overview

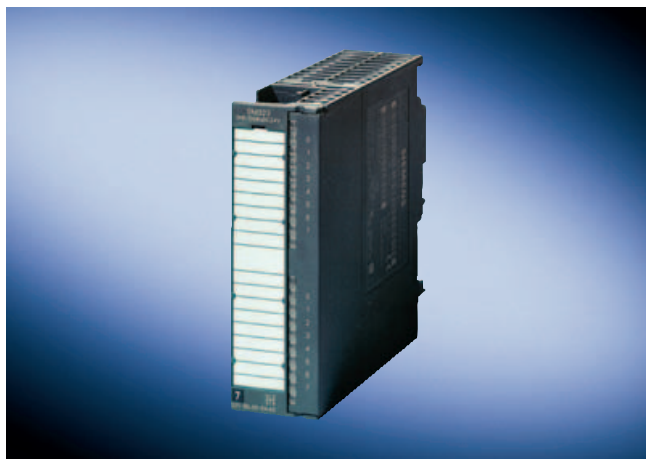

- Digital inputs and outputs
- For connecting standard switches, two-wire proximity switches (BERO), solenoid valves, contactors, low-power motors, lamps and motor starters

SIPLUS SM 323	8 DI/8 DO
Order No.	6AG1 323-1BH01-2AA0
Order No. based on	6ES7 323-1BH01-0AA0
Ambient temperature range	-25 °C to +60 °C, condensation permissible
Ambient conditions	Suitable for extraordinary medial load (for example by chloric and sulphuric atmospheres).
Conformity with standard for electronic devices on rail vehicles (EN 50155, temperature T1, category 1)	Yes
Technical data	The technical data are identical with the technical data of the based on modules.

Ordering data	Order No.	Ordering data	Order No.
Digital input/output modules SIPLUS SM 323 (extended temperature range and medial load) incl. labeling strips, bus connector 8 inputs, 8 outputs	A) 6AG1 323-1BH01-2AA0	Accessories see S7-300 digital input/output modules, page 4/107	
A) Subject to export regulations: AL: N and ECCN: EAR99H			

www.DataSheet4U.com

Overview



- Analog inputs
- For connection of voltage and current sensors, thermocouples, resistors and resistance thermometers

4

Technical specifications

	6ES7 331-7KF02-0AB0	6ES7 331-7HF01-0AB0	6ES7 331-1KF01-0AB0	6ES7 331-7KB02-0AB0
Voltages and currents				
Load voltage L+				
• Rated value (DC)	24 V	24 V		24 V
• reverse polarity protection	Yes	Yes		Yes
Current consumption				
from load voltage L+ (without load), max.	200 mA	50 mA		80 mA
from backplane bus DC 5 V, max.	50 mA	60 mA	90 mA	50 mA
Power loss, typ.	1 W	1.5 W	0.4 W	1.3 W
Connection point				
required front connectors	20-pin	20-pin	40-pin	20-pin
Isochronous mode				
Isochronous mode	No	Yes	No	No
Analog inputs				
Number of analog inputs	8	8	8	2
Number of analog inputs for resistance measurement	4		8	1
Cable length, shielded, max.	200 m; 50 m at 80 mV and with thermocouples	200 m	200 m; max. 50 m at 50 mV	200 m; 50 m at 80 mV and with thermocouples
permissible input frequency for voltage input (destruction limit), max.	20 V; continuous; 75 V for max. 1s (mark to space ratio 1:20)	20 V; 20 V continuous, 75 V for max. 1s (mark to space ratio 1:20)	30 V; 12 V continuous, 30 V for max. 1 s	20 V; continuous; 75 V for max. 1s (mark to space ratio 1:20)
permissible input current for current input (destruction limit), max.	40 mA	40 mA	40 mA	40 mA
Input ranges (rated values), voltages				
• 0 to +10 V			Yes	
• 1 to 5 V	Yes	Yes	Yes	Yes
• 1 to 10 V		Yes	No	
• -1 V to +1 V	Yes	Yes	Yes	Yes
• -10 V to +10 V	Yes	Yes	Yes	Yes
• -2.5 V to +2.5 V	Yes		No	Yes
• -250 mV to +250 mV	Yes		No	Yes
• -5 V to +5 V	Yes	Yes	Yes	Yes

SIMATIC S7-300

Analog modules

SM 331 analog input modules

Technical specifications (continued)

	6ES7 331-7KF02-0AB0	6ES7 331-7HF01-0AB0	6ES7 331-1KF01-0AB0	6ES7 331-7KB02-0AB0
Input ranges (rated values), voltages (continued)				
• -50 mV to +50 mV			Yes	
• -500 mV to +500 mV	Yes		Yes	Yes
• -80 mV to +80 mV	Yes			Yes
Input ranges (rated values), currents				
• 0 to 20 mA	Yes	Yes	Yes	Yes
• -10 to +10 mA	Yes			Yes
• -20 to +20 mA	Yes	Yes	Yes	Yes
• -3.2 to +3.2 mA	Yes			Yes
• 4 to 20 mA	Yes	Yes	Yes	Yes
Input ranges (rated values), thermoelements				
• Type E	Yes			Yes
• Type J	Yes			Yes
• Type K	Yes			Yes
• Type N	Yes			Yes
Input ranges (rated values), resistors				
• 0 to 150 Ohm	Yes			Yes
• 0 to 300 Ohm	Yes			Yes
• 0 to 600 Ohm	Yes		Yes	Yes
• 0 to 6000 Ohm			Yes	
Input ranges (rated values), resistance thermometers				
• Ni 100	Yes; Standard		Yes; Standard/AirCon	Yes
• LG-Ni 1000			Yes; Standard/AirCon	
• Pt 100	Yes; Standard		Yes; Standard/AirCon	Yes
Characteristic linearization				
• programmable	Yes		Yes	Yes
• for thermoelements	Type N, E, J, K, L			Type N, E, J, K, L
• for thermoresistor	Pt 100 (Standard, climatic range), Ni 100 (Standard, climatic range)		yes; Pt100 standard/air con.; Ni100 standard/air con.; Ni1000 standard/air con.; LG-Ni1000 standard/air con.	Pt 100 (Standard, climatic range), Ni 100 (Standard, climatic range)
Temperature compensation				
• programmable	Yes			Yes
• external temperature compensation with compensations socket	Yes			Yes
• internal temperature compensation	Yes			Yes
Analog value creation				
Measurement principle	integrating	Conversion of instantaneous values	integrating	integrating
Integrations and conversion time/resolution per channel				
• Resolution with overload area (bit including sign), max.	15 Bit; unipolar: 9 / 12 / 12 / 14 bit, bipolar: 9 + sign/12 + sign/12 + sign/14 + sign bit	14 Bit; unipolar: 14 bit; bipolar: 13+sign bit	13 Bit	15 Bit; unipolar: 9 / 12 / 12 / 14 bit, bipolar: 9 + sign/12 + sign/12 + sign/14 + sign bit

www.DataSheet4U.com
Technical specifications (continued)

	6ES7 331-7KF02-0AB0	6ES7 331-7HF01-0AB0	6ES7 331-1KF01-0AB0	6ES7 331-7KB02-0AB0
Integrations and conversion time/resolution per channel (continued)				
• Integration time, parameterizable	Yes; 2.5 / 16.67 / 20 / 100 ms	Yes	Yes; 60 / 50 ms	Yes; 2.5 / 16.67 / 20 / 100 ms
• Basic conversion time, including integration time, ms	3/ 17/ 22/ 102 ms		66 / 55 ms	6/ 34/ 44/ 204 ms
• Basic conversion time, ms		52 µs per channel	66 / 55 ms	
• Interference voltage suppression for interference frequency f1 in Hz	400 / 60 / 50 / 10 Hz	400 / 60 / 50 / 10 Hz	50 / 60 Hz	400 / 60 / 50 / 10 Hz
Encoder				
Connection of signal encoders				
• for current measurement as 2-wire transducer	Yes	Yes	Yes; with external supply	Yes
• for current measurement as 4-wire transducer	Yes	Yes	Yes	Yes
• for resistance measurement with 2-conductor connection	Yes		Yes	Yes
• for resistance measurement with 3-conductor connection	Yes		Yes	Yes
• for resistance measurement with 4-conductor connection	Yes		Yes	Yes
Errors/accuracies				
Operational limit in overall temperature range				
• Voltage, relative to input area	+/- 1 %; +/-1% (80mV), +/-0.6% (250-1000mV), +/-0.8% (2.5-10mV)	+/- 0.4 %	+/- 0.6 %; +/-0.6% (+/-5V,10V,1-5V,0-10V; +/-0.5% (+/-50 mV, 500 mV, 1 V	+/- 1 %; +/-1% (80mV), +/- 0.6% (250-1000mV), +/- 0.8% (2.5-10V)
• Current, relative to input area	+/- 0.7 %; from 3.2 to 20mA	+/- 0.3 %	+/- 0.5 %; +/-20mA, 0-20mA, 4-20mA	+/- 0.7 %; from 3.2 to 20mA
• Impedance, relative to input area	+/- 0.7 %; 150, 300, 600 Ohm		+/- 0.5 %; 0-6kOhm, 0-600kOhm	+/- 0.7 %; 150, 300, 600 Ohm
• Resistance-type thermometer, relative to input area	+/- 0.7 %; +/-0.7% (Pt100/ Ni100); +/-0.8% (Pt100 climat)			+/- 0.7 %; +/-0.7% (Pt100/ Ni100); +/-0.8% (Pt100 climat)
Basic error limit (operational limit at 25 °C)				
• Voltage, relative to input area	+/- 0.6 %; +/-0.4% (250-1000mV); +/-0.6% (2.5-10mV); +/-0.7% (80mV)	+/- 0.25 %	+/- 0.4 %; 0.4% (+/-5V,10V,1-5V, 0-10V); 0.3% (+/-50mV,500mV,1V)	+/- 0.6 %; +/-0.6% (80mV, 2.5-10V); +/-0.4% (250-1000mV)
• Current, relative to input area	+/- 0.5 %; 3,2 to 20mA	+/- 0.2 %	+/- 0.3 %; +/-20mA, 0-20mA,4-20mA	+/- 0.5 %; 3,2 to 20mA
• Impedance, relative to input area	+/- 0.5 %; 150, 300, 600 Ohm		+/- 0.3 %; 0-6kOhm, 0-600kOhm	+/- 0.5 %; 150, 300, 600 Ohm
• Resistance-type thermometer, relative to input area	+/- 0.6 %; +/-0.5% (Pt100/ Ni100); +/-0.6% (Pt100 climatic)			+/- 0.6 %; +/-0.5% (Pt100/ Ni100); +/-0.6% (Pt100 climatic)
Status information/alarms/diagnostics				
Alarms				
• Diagnostic alarm	Yes; parameterizable channels 0 and 2	Yes; parameterizable	No	Yes
• Limit value alarm	Yes; parameterizable	Yes; parameterizable channels 0 and 2	No	Yes; parameterizable; Channel 0
Diagnoses				
• Diagnostic information readable	Yes	Yes	No	Yes

SIMATIC S7-300

Analog modules

SM 331 analog input modules

Technical specifications (continued)

	6ES7 331-7KF02-0AB0	6ES7 331-7HF01-0AB0	6ES7 331-1KF01-0AB0	6ES7 331-7KB02-0AB0
Isolation				
Isolation checked with	500 V DC	500 V DC	500 V DC	500 V DC
Isolation				
Isolation, analog inputs				
• between the channels	Yes	No	No	No
• between the channels, in groups of 2	2			
• between the channels and the backplane bus	Yes	Yes	Yes	Yes
Dimensions and weight				
Width	40 mm	40 mm	40 mm	40 mm
Height	125 mm	125 mm	125 mm	125 mm
Depth	120 mm	120 mm	117 mm	120 mm
Weights				
Weight, approx.	250 g	200 g	250 g	250 g
	6ES7 331-7PF01-0AB0	6ES7 331-7PF11-0AB0	6ES7 331-7NF00-0AB0	6ES7 331-7NF10-0AB0
Voltages and currents				
Load voltage L+				
• Rated value (DC)	24 V	24 V		24 V
• reverse polarity protection	Yes	Yes		Yes
Current consumption				
from load voltage L+ (without load), max.	240 mA	200 mA		200 mA
from backplane bus DC 5 V, max.	100 mA	100 mA	130 mA	100 mA
Power loss, typ.	4.6 W	3 W	0.6 W	3 W
Connection point				
required front connectors	40-pin	40-pin	40-pin	40-pin
Isochronous mode				
Isochronous mode	No	No	No	No
Analog inputs				
Number of analog inputs	8	8	8	8
Number of analog inputs for resistance measurement	8			
Cable length, shielded, max.	200 m	100 m	200 m	200 m
permissible input frequency for voltage input (destruction limit), max.	75 V; 35 V continuous, 75 V for max. 1 s (mark to space ratio 1:20)	75 V; 20 V DC permanent, 75 V DC for max. 1 s (pulse duty factor 1:20)	50 V; permanent	75 V; 35 V continuous, 75 V for max. 1 s (mark to space ratio 1:20)
permissible input current for current input (destruction limit), max.			32 mA	40 mA
Input ranges (rated values), voltages				
• 1 to 5 V			Yes	Yes
• -10 V to +10 V			Yes	Yes
• -5 V to +5 V			Yes	Yes
Input ranges (rated values), currents				
• 0 to 20 mA			Yes	Yes
• -20 to +20 mA			Yes	Yes
• 4 to 20 mA			Yes	Yes

SIMATIC S7-300

Analog modules

SM 331 analog input modules

4

Technical specifications (continued)

	6ES7 331-7PF01-0AB0	6ES7 331-7PF11-0AB0	6ES7 331-7NF00-0AB0	6ES7 331-7NF10-0AB0
Input ranges (rated values), thermoelements				
• Type B		Yes		
• Type E		Yes		
• Type J		Yes		
• Type K		Yes		
• Type L		Yes		
• Type N		Yes		
• Type R		Yes		
• Type S		Yes		
• Type T		Yes		
• Type U		Yes		
• Typ TXK/TXK(L) to GOST		Yes		
Input ranges (rated values), resistors				
• 0 to 150 Ohm	Yes			
• 0 to 300 Ohm	Yes			
• 0 to 600 Ohm	Yes			
Input ranges (rated values), resistance thermometers				
• Cu 10	Yes			
• Ni 100	Yes			
• Ni 1000	Yes			
• Ni 120	Yes			
• Ni 200	Yes			
• Ni 500	Yes			
• Pt 100	Yes			
• Pt 1000	Yes			
• Pt 200	Yes			
• Pt 500	Yes			
Characteristic linearization				
• programmable	Yes	Yes		
• for thermoelements		Type B, E, J, K, L, N, R, S, T, U, C		
• for thermoresistor	Pt 100, Pt 200, Pt 500, Pt 1000, Ni 100, Ni 120, Ni 200, Ni 500, Ni 1000, Cu 10 (Standard/AirCon)			
Temperature compensation				
• programmable		Yes		
• external temperature compensation with compensations socket		Yes		
• external temperature compensation with Pt100		Yes		
• internal temperature compensation		Yes		

SIMATIC S7-300

Analog modules

SM 331 analog input modules

Technical specifications (continued)

	6ES7 331-7PF01-0AB0	6ES7 331-7PF11-0AB0	6ES7 331-7NF00-0AB0	6ES7 331-7NF10-0AB0
Analog value creation				
Measurement principle	integrating	integrating	integrating	integrating
Integrations and conversion time/resolution per channel				
<ul style="list-style-type: none"> Resolution with overload area (bit including sign), max. 	16 Bit; Two's complement	16 Bit; Two's complement	16 Bit; unipolar: 15 / 15 / 15 / 15 bit, bipolar: 15 + sign/15 + sign/ 15 + sign/15 + sign	16 Bit; unipolar: 15 / 15 / 15 / 15 bit, bipolar: 15 + sign/15 + sign/ 15 + sign/15 + sign
<ul style="list-style-type: none"> Integration time, parameterizable 	Yes	Yes	Yes; 10 / 16.67 / 20 / 100 ms	Yes; 23 / 72 / 83 / 95 ms
<ul style="list-style-type: none"> Basic conversion time, ms 	up to 4 channels: 10 ms per module, over 5 channels: 190 ms per module, 8 channels: 80 ms	up to 4 channels: 10 ms per module, as of 5 channels: 190 ms per module		10 ms (4-channel mode) 95 / 83/ 72/ 23 ms (8-channel mode)
<ul style="list-style-type: none"> Interference voltage suppression for interference frequency f_1 in Hz 	400 / 60 / 50 Hz	400 / 60 / 50 Hz	400 / 60 / 50 / 10 Hz	400 / 60 / 50 Hz, combinations of 400, 60, 50 Hz
Encoder				
Connection of signal encoders				
<ul style="list-style-type: none"> for current measurement as 2-wire transducer 			Yes; with external transmitter; possible with separate supply for transmitter	Yes; with external transmitter, current supply; possible with separate supply for transmitter
<ul style="list-style-type: none"> for current measurement as 4-wire transducer 			Yes	Yes
<ul style="list-style-type: none"> for resistance measurement with 2-conductor connection 	Yes; without resistance correction			
<ul style="list-style-type: none"> for resistance measurement with 3-conductor connection 	Yes			
<ul style="list-style-type: none"> for resistance measurement with 4-conductor connection 	Yes			
Errors/accuracies				
Operational limit in overall temperature range				
<ul style="list-style-type: none"> Voltage, relative to input area 		+/- 1 K	+/- 0.1 %; +/-0.7%	+/- 0.1 %
<ul style="list-style-type: none"> Current, relative to input area 			+/- 0.3 %; +/-0.9%	+/- 0.1 %
<ul style="list-style-type: none"> Impedance, relative to input area 	+/- 0.1 %			
Basic error limit (operational limit at 25 °C)				
<ul style="list-style-type: none"> Voltage, relative to input area 		+/- 0.5 K	+/- 0.05 %	+/- 0.05 %
<ul style="list-style-type: none"> Current, relative to input area 			+/- 0.05 %	+/- 0.05 %
<ul style="list-style-type: none"> Impedance, relative to input area 	+/- 0.05 %			

SIMATIC S7-300

Analog modules

SM 331 analog input modules

Technical specifications (continued)

	6ES7 331-7PF01-0AB0	6ES7 331-7PF11-0AB0	6ES7 331-7NF00-0AB0	6ES7 331-7NF10-0AB0
Status information/alarms/diagnostics				
Alarms				
• Diagnostic alarm	Yes; parameters can be set per group	Yes; parameters can be set per group	Yes; parameterizable	Yes; parameterizable
• Limit value alarm	Yes; parameterizable	Yes; parameterizable	Yes; parameterizable channels 0 and 2	Yes; parameterizable all channels (end of cycle interrupt is also supported across modules)
Diagnoses				
• Diagnostic information readable	Yes	Yes	Yes	Yes
Isolation				
Isolation checked with				
	500 V DC	500 V DC	500 V DC	500 V AC
Isolation				
Isolation, analog inputs				
• between the channels	Yes	Yes		Yes
• between the channels, in groups of	2	2		2
• between the channels and the backplane bus	Yes	Yes	Yes	Yes
Dimensions and weight				
Width				
	40 mm	40 mm	40 mm	40 mm
Height				
	125 mm	125 mm	125 mm	125 mm
Depth				
	120 mm	120 mm	120 mm	120 mm
Weights				
Weight, approx.				
	272 g	272 g	272 g	272 g

SIMATIC S7-300

Analog modules

SM 331 analog input modules

Ordering data	Order No.	Order No.
SM 331 analog input modules		
Including labeling strips, bus connector, measuring range modules		
8 inputs, 13-bit resolution	6ES7 331-1KF01-0AB0	Label cover 10 units (spare part), for modules with 20-pin front connector
8 inputs, resolution 9/12/14 bits	6ES7 331-7KF02-0AB0	Labeling strips 10 units (spare part), for modules with 20-pin front connector
2 inputs, resolution 9/12/14 bits A)	6ES7 331-7KB02-0AB0	S7 SmartLabel Software for automatic labeling of modules based on data of the STEP 7 project
8 inputs, enhanced resolution 16 bits A)	6ES7 331-7NF00-0AB0	Labeling sheets for machine labeling For 16-channel signal modules, DIN A4, for printing with laser printer; 10 units
8 inputs, enhanced resolution 16 bits, 4-channel mode A)	6ES7 331-7NF10-0AB0	petrol 6ES7 392-2AX00-0AA0
8 inputs, resolution 14 bits, for isochronous mode	6ES7 331-7HF01-0AB0	light-beige 6ES7 392-2BX00-0AA0
8 inputs, for thermal resistors A)	6ES7 331-7PF01-0AB0	yellow 6ES7 392-2CX00-0AA0
8 inputs, for thermoelements	6ES7 331-7PF11-0AB0	red 6ES7 392-2DX00-0AA0
Measuring range module for analog inputs	6ES7 974-0AA00-0AA0	For 32-channel signal modules, DIN A4, for printing with laser printer; 10 units
1 module for 2 analog inputs; 2 units (spare part)		petrol 6ES7 392-2AX10-0AA0
Front connectors		light-beige 6ES7 392-2BX10-0AA0
1 unit		yellow 6ES7 392-2CX10-0AA0
20-pin, with screw contacts		red 6ES7 392-2DX10-0AA0
• 1 unit	6ES7 392-1AJ00-0AA0	SIMATIC Manual Collection D)
• 100 units	6ES7 392-1AJ00-1AB0	Electronic manuals on DVD, multilingual: S7-200, S7-300, C7, S7-400, SIMATIC DP (Distributed I/O), SIMATIC PC, SIMATIC PG, STEP 7, Engineering Tools, Runtime Software, SIMATIC PCS 7, SIMATIC HMI (Human Machine Interface), SIMATIC NET (Industrial Communication), SIMATIC Machine Vision, SIMATIC Sensors
20-pin, with cage clamp terminals		6ES7 998-8XC01-8YE0
• 1 unit	6ES7 392-1BJ00-0AA0	
• 100 units	6ES7 392-1BJ00-1AB0	
40-pin, with screw contacts		
• 1 unit	6ES7 392-1AM00-0AA0	
• 100 units	6ES7 392-1AM00-1AB0	
40-pin, with cage clamp terminals		
• 1 unit	6ES7 392-1BM01-0AA0	
• 100 units	6ES7 392-1BM01-1AB0	
Front door, elevated design A)	6ES7 328-0AA00-7AA0	SIMATIC Manual Collection update service for 1 year D)
e.g. for 32-channel modules; for connecting 1.3 mm ² /16 AWG wires		Current S7 Manual Collection DVD and the three subsequent updates
SIMATIC TOP connect	See page 4/225; Information about which components can be used for the respective module, see A&D Mall or Catalog KT 10.2	S7-300 manual Design, CPU data, module data, instruction list
Bus connectors	6ES7 390-0AA00-0AA0	German 6ES7 398-8FA10-8AA0
1 unit (spare part)		English 6ES7 398-8FA10-8BA0
Shield connecting element	6ES7 390-5AA00-0AA0	French 6ES7 398-8FA10-8CA0
80 mm wide, with 2 rows for 4 shielding connection clamps each		Spanish 6ES7 398-8FA10-8DA0
Shielding connection clamps		Italian 6ES7 398-8FA10-8EA0
2 units		
For 2 cables with 2 mm to 6 mm diameter	6ES7 390-5AB00-0AA0	
For 1 cable with 3 mm to 8 mm diameter	6ES7 390-5BA00-0AA0	
For 1 cable with 4 mm to 13 mm diameter	6ES7 390-5CA00-0AA0	

A) Subject to export regulations: AL: N and ECCN: EAR99H

D) Subject to export regulations: AL: N and ECCN: 5D992B1

www.DataSheet4U.com

Overview



- Analog outputs
- For the connection of analog actuators

4

Technical specifications

	6ES7 332-5HB01-0AB0	6ES7 332-5HD01-0AB0	6ES7 332-5HF00-0AB0	6ES7 332-7ND02-0AB0
Voltages and currents				
Load voltage L+				
• Rated value (DC)	24 V	24 V	24 V	24 V
Current consumption				
from load voltage L+ (without load), max.	135 mA	240 mA	340 mA	290 mA
from backplane bus DC 5 V, max.	60 mA	60 mA	100 mA	120 mA
Power loss, typ.	3 W	3 W	6 W	3 W
Connection point				
required front connectors	20-pin	20-pin	40-pin	20-pin
Analog outputs				
Number of analog outputs	2	4	8	4; isochronous mode
Cable length, shielded, max.	200 m	200 m	200 m	200 m
Voltage output, short-circuit protection	Yes	Yes	Yes	Yes
Voltage output, short-circuit current, max.	25 mA	25 mA	25 mA	40 mA
Current output, no-load voltage, max.	18 V	18 V	18 V	18 V
Output ranges, voltage				
• 0 to 10 V	Yes	Yes	Yes	Yes
• 1 to 5 V	Yes	Yes	Yes	Yes
• -10 to +10 V	Yes	Yes	Yes	Yes
Output ranges, current				
• 0 to 20 mA	Yes	Yes	Yes	Yes
• -20 to +20 mA	Yes	Yes	Yes	Yes
• 4 to 20 mA	Yes	Yes	Yes	Yes
Load impedance (in rated range of output)				
• with voltage outputs, min.	1 k Ω	1 k Ω	1 k Ω	1 k Ω
• with voltage outputs, capacitive load, max.	1 μ F	1 μ F	1 μ F	1 μ F
• with current outputs, max.	500 Ω	500 Ω	500 Ω	500 Ω
• with current outputs, inductive load, max.	10 mH	10 mH	10 mH	1 mH

SIMATIC S7-300

Analog modules

SM 332 analog output modules

Technical specifications (continued)

	6ES7 332-5HB01-0AB0	6ES7 332-5HD01-0AB0	6ES7 332-5HF00-0AB0	6ES7 332-7ND02-0AB0
Analog value creation				
Integrations and conversion time/resolution per channel				
<ul style="list-style-type: none"> Resolution with overload area (bit including sign), max. 	12 Bit; +/- 10 V, +/-20mA, 4 to 20 mA, 1 to 5 V: 11 bit + sign, 0 to 10 V, 0 to 20 mA: 12 bit	12 Bit; +/- 10 V, +/- 20mA, 4 to 20 mA, 1 to 5 V: 11 bit + sign, 0 to 10 V, 0 to 20 mA: 12 bit	12 Bit; +/- 10 V, +/- 20mA, 4 to 20 mA, 1 to 5 V: 11 bit + sign, 0 to 10 V, 0 to 20 mA: 12 bit	16 Bit
<ul style="list-style-type: none"> Conversion time (per channel) 	0,8 ms	0,8 ms	0,8 ms	200 µs; in clocked mode 640µs
Settling time				
<ul style="list-style-type: none"> for resistive load for capacitive load for inductive load 	0.2 ms 3.3 ms 0.5 ms; 0.5 ms (1mH); 3.3ms (10mH)	0.2 ms 3.3 ms 0.5 ms; 0.5ms (1mH); 3.3ms (10mH)	0.2 ms 3.3 ms 0.5 ms; 0.5ms (1mH); 3.3ms (10mH)	0.2 ms 3.3 ms 0.5 ms
Errors/accuracies				
Operational limit in overall temperature range				
<ul style="list-style-type: none"> Voltage, relative to output area Current, relative to output area 	+/- 0.5 % +/- 0.6 %	+/- 0.5 % +/- 0.6 %	+/- 0.5 % +/- 0.6 %	+/- 0.12 % +/- 0.18 %
Basic error limit (operational limit at 25 °C)				
<ul style="list-style-type: none"> Voltage, relative to output area Current, relative to output area 	+/- 0.4 % +/- 0.5 %	+/- 0.4 % +/- 0.5 %	+/- 0.4 % +/- 0.5 %	+/- 0.02 % +/- 0.02 %
Status information/alarms/diagnostics				
Substitute values connectable	Yes; parameterizable	Yes; parameterizable	Yes; parameterizable	Yes; parameterizable
Alarms				
<ul style="list-style-type: none"> Diagnostic alarm 	Yes; parameterizable	Yes; parameterizable	Yes; parameterizable	Yes
Diagnoses				
<ul style="list-style-type: none"> Diagnostic information readable 	Yes	Yes	Yes	
Isolation				
Isolation checked with	500 V DC	500 V DC	500 V DC	1500 V DC
Isolation				
Isolation, analog outputs				
<ul style="list-style-type: none"> between the channels and the backplane bus 	Yes	Yes	Yes	Yes
Dimensions and weight				
Width	40 mm	40 mm	40 mm	40 mm
Height	125 mm	125 mm	125 mm	125 mm
Depth	120 mm	120 mm	120 mm	120 mm
Weights				
Weight, approx.	220 g	220 g	272 g	220 g

SIMATIC S7-300

Analog modules

SM 332 analog output modules

Ordering data	Order No.	Order No.
SM 332 analog output modules		
incl. labeling strips, bus connector		6ES7 392-2XX00-0AA0
4 outputs, 11/12 bit	6ES7 332-5HD01-0AB0	
4 outputs, 16 bit	A) 6ES7 332-7ND02-0AB0	
2 outputs, 11/12 bit	6ES7 332-5HB01-0AB0	
8 outputs, 11/12 bit	6ES7 332-5HF00-0AB0	
Front connectors		
20-pin, with screw contacts		
• 1 unit	6ES7 392-1AJ00-0AA0	
• 100 units	6ES7 392-1AJ00-1AB0	
20-pin, with cage clamp terminals		
• 1 unit	6ES7 392-1BJ00-0AA0	
• 100 units	6ES7 392-1BJ00-1AB0	
40-pin, with screw contacts		
• 1 unit	6ES7 392-1AM00-0AA0	
• 100 units	6ES7 392-1AM00-1AB0	
40-pin, with cage clamp terminals		
• 1 unit	6ES7 392-1BM01-0AA0	
• 100 units	6ES7 392-1BM01-1AB0	
Front door, elevated design A)	6ES7 328-0AA00-7AA0	
e.g. for 32 channel modules; for connecting 1.3 mm ² /16 AWG wires		
SIMATIC TOP connect	See page 4/225; Information about which components can be used for the respective module, see A&D Mall or Catalog KT 10.2	
Bus connectors		
1 unit (spare part)	6ES7 390-0AA00-0AA0	
Shield connecting element	6ES7 390-5AA00-0AA0	
80 mm wide, with 2 rows for 4 shielding connection clamps each		
Shielding connection clamps		
2 units		
For 2 cables with 2 mm to 6 mm diameter	6ES7 390-5AB00-0AA0	
For 1 cable with 3 mm to 8 mm diameter	6ES7 390-5BA00-0AA0	
For 1 cable with 4 mm to 13 mm diameter	6ES7 390-5CA00-0AA0	
Label cover	6ES7 392-2XY00-0AA0	
10 units (spare part), for modules with 20-pin front connector		
	Labeling strips	
	10 units (spare part), for modules with 20-pin front connector	
	S7 SmartLabel	2XV9 450-1SL01-0YX0
	Software for automatic labeling of modules based on data of the STEP 7 project	
	Labeling sheets for machine labeling	
	For 16-channel signal modules, DIN A4, for printing with laser printer; 10 units	
	petrol	6ES7 392-2AX00-0AA0
	light-beige	6ES7 392-2BX00-0AA0
	yellow	6ES7 392-2CX00-0AA0
	red	6ES7 392-2DX00-0AA0
	For 32-channel signal modules, DIN A4, for printing with laser printer; 10 units	
	petrol	6ES7 392-2AX10-0AA0
	light-beige	6ES7 392-2BX10-0AA0
	yellow	6ES7 392-2CX10-0AA0
	red	6ES7 392-2DX10-0AA0
	SIMATIC Manual Collection D)	6ES7 998-8XC01-8YE0
	Electronic manuals on DVD, multilingual: S7-200, S7-300, C7, S7-400, SIMATIC DP (Distributed I/O), SIMATIC PC, SIMATIC PG, STEP 7, Engineering Tools, Runtime Software, SIMATIC PCS 7, SIMATIC HMI (Human Machine Interface), SIMATIC NET (Industrial Communication), SIMATIC Machine Vision, SIMATIC Sensors	
	SIMATIC Manual Collection D)	6ES7 998-8XC01-8YE2
	update service for 1 year	
	Current S7 Manual Collection DVD and the three subsequent updates	
	S7-300 manual	
	Design, CPU data, module data, instruction list	
	German	6ES7 398-8FA10-8AA0
	English	6ES7 398-8FA10-8BA0
	French	6ES7 398-8FA10-8CA0
	Spanish	6ES7 398-8FA10-8DA0
	Italian	6ES7 398-8FA10-8EA0

A) Subject to export regulations: AL: N and ECCN: EAR99H

D) Subject to export regulations: AL: N and ECCN: 5D992B1

SIMATIC S7-300

Analog modules

SM 334 analog input/output modules

www.DataSheet4U.com

Overview

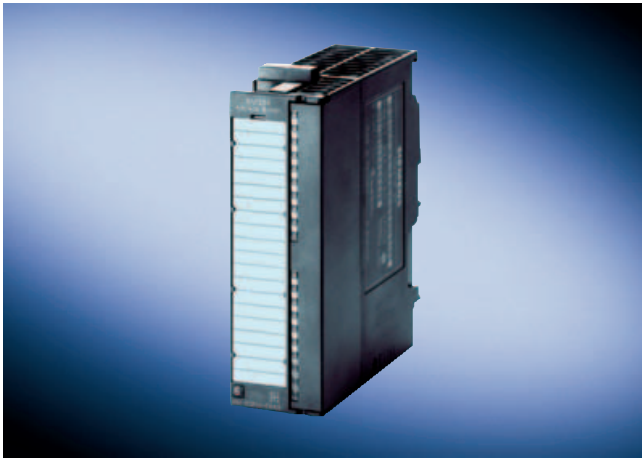

- Analog inputs and outputs
- For the connection of analog sensors and actuators

Technical specifications

	6ES7 334-0CE01-0AA0	6ES7 334-0KE00-0AB0
Voltages and currents		
Load voltage L+		
• Rated value (DC)	24 V	24 V
Current consumption		
from load voltage L+ (without load), max.	110 mA	80 mA
from backplane bus DC 5 V, max.	55 mA	60 mA
Power loss, typ.	3 W	2 W
Connection point		
required front connectors	20-pin	20-pin
Analog inputs		
Number of analog inputs	4	4
Number of analog inputs for voltage measurement	4	2
Number of analog inputs for resistance measurement		4
permissible input frequency for voltage input (destruction limit), max.	20 V	20 V; continuous; 75 V for max. 1s (mark to space ratio 1:20)
permissible input current for current input (destruction limit), max.	40 mA	
Cycle time (all channels) max.	5 ms	85 ms
Input ranges (rated values), voltages		
• 0 to +10 V	Yes	Yes
Input ranges (rated values), currents		
• 0 to 20 mA	Yes	
Input ranges (rated values), resistors		
• 0 to 10000 Ohm		Yes
Input ranges (rated values), resistance thermometers		
• Pt 100		Yes; only climatic range

	6ES7 334-0CE01-0AA0	6ES7 334-0KE00-0AB0
Analog outputs		
Number of analog outputs	2	2
Cable length, shielded, max.	200 m	100 m
Voltage output, short-circuit protection	Yes	Yes
Voltage output, short-circuit current, max.	11 mA	10 mA
Current output, no-load voltage, max.	15 V	
Output ranges, voltage		
• 0 to 10 V	Yes	Yes
Output ranges, current		
• 0 to 20 mA	Yes	
Load impedance (in rated range of output)		
• with voltage outputs, min.	5 kΩ	2.5 kΩ
• with voltage outputs, capacitive load, max.	1 μF	1 μF
• with current outputs, max.	300 Ω	
• with current outputs, inductive load, max.	1 mH	
Analog value creation		
Integrations and conversion time/resolution per channel		
• Resolution with overload area (bit including sign), max.	8 Bit	12 Bit
• Integration time, ms		16.67; 20
Settling time		
• for resistive load	0.3 ms	0.8 ms
• for capacitive load	3 ms	0.8 ms
• for inductive load	0.3 ms	

www.DataSheet4U.com

SIMATIC S7-300

Analog modules

SM 334 analog input/output modules

4

Technical specifications (continued)

	6ES7 334-0CE01-0AA0	6ES7 334-0KE00-0AB0
Encoder		
Connection of signal encoders		
• for current measurement as 4-wire transducer	Yes	
• for resistance measurement with 2-conductor connection		Yes
• for resistance measurement with 3-conductor connection		Yes
• for resistance measurement with 4-conductor connection		Yes
Errors/accuracies		
Operational limit in overall temperature range		
• Voltage, relative to output area	+/- 0.6 %	+/- 1 %
• Current, relative to output area	+/- 1 %	
• Voltage, relative to input area	+/- 0.9 %	+/- 0.7 %; 0 to 10 V
• Current, relative to input area	+/- 0.8 %	
• Impedance, relative to input area		+/- 3.5 %; 10 kOhm
• Resistance-type thermometer, relative to input area		+/- 1 %
Basic error limit (operational limit at 25 °C)		
• Voltage, relative to output area	+/- 0.5 %	+/- 0.85 %
• Current, relative to output area	+/- 0.5 %	
• Voltage, relative to input area	+/- 0.7 %	+/- 0.5 %; 0 to 10 V

	6ES7 334-0CE01-0AA0	6ES7 334-0KE00-0AB0
Basic error limit (operational limit at 25 °C) (continued)		
• Current, relative to input area	+/- 0.6 %	
• Impedance, relative to input area		+/- 2.8 %; 10 kOhm
• Resistance-type thermometer, relative to input area		+/- 0.8 %
Status information/alarms/diagnostics		
Alarms		
• Alarms	No	No
Diagnoses		
• Diagnostic functions	No	No
Isolation		
Isolation checked with	DC 500 V	DC 500 V
Isolation		
Isolation, analog outputs		
• between the channels and the backplane bus	No	Yes
Isolation, analog inputs		
• between the channels and the backplane bus	No	Yes
Dimensions and weight		
Width	40 mm	40 mm
Height	125 mm	125 mm
Depth	120 mm	120 mm
Weights		
Weight, approx.	285 g	200 g

SIMATIC S7-300

Analog modules

SM 334 analog input/output modules

www.DataSheet4U.com

Ordering data	Order No.	Ordering data	Order No.
SM 334 analog input/output modules		S7 SmartLabel	2XV9 450-1SL01-0YX0
incl. labeling strips, bus connector		Software for automatic labeling of modules based on data of the STEP 7 project	
4 inputs, 2 outputs	6ES7 334-0CE01-0AA0	Labeling sheets for machine labeling	
4 inputs, 2 outputs, resistance measurement, Pt 100	6ES7 334-0KE00-0AB0	for 16-channel signal modules, DIN A4, for printing with laser printer; 10 units	
Front connectors		petrol	6ES7 392-2AX00-0AA0
20-pin, with screw contacts		light-beige	6ES7 392-2BX00-0AA0
• 1 unit	6ES7 392-1AJ00-0AA0	yellow	6ES7 392-2CX00-0AA0
• 100 units	6ES7 392-1AJ00-1AB0	red	6ES7 392-2DX00-0AA0
20-pin, with cage clamp terminals		SIMATIC Manual Collection ^{D)}	6ES7 998-8XC01-8YE0
• 1 unit	6ES7 392-1BJ00-0AA0	Electronic manuals on DVD, multilingual: S7-200, S7-300, C7, S7-400, SIMATIC DP (Distributed I/O), SIMATIC PC, SIMATIC PG, STEP 7, Engineering Tools, Runtime Software, SIMATIC PCS 7, SIMATIC HMI (Human Machine Interface), SIMATIC NET (Industrial Communication), SIMATIC Machine Vision, SIMATIC Sensors	
• 100 units	6ES7 392-1BJ00-1AB0		
Front door, elevated design ^{A)}	6ES7 328-0AA00-7AA0	SIMATIC Manual Collection update service for 1 year ^{D)}	6ES7 998-8XC01-8YE2
e.g. for 32 channel modules; for connecting 1.3 mm ² /16 AWG wires		Current S7 Manual Collection DVD and the three subsequent updates	
SIMATIC TOP connect	See page 4/225; Information about which components can be used for the respective module, see A&D Mall or Catalog KT 10.2	S7-300 manual	
		Design, CPU data, module data, instruction list	
Bus connectors	6ES7 390-0AA00-0AA0	German	6ES7 398-8FA10-8AA0
1 unit (spare part)		English	6ES7 398-8FA10-8BA0
Shield connecting element	6ES7 390-5AA00-0AA0	French	6ES7 398-8FA10-8CA0
80 mm wide, with 2 rows for 4 shielding connection clamps each		Spanish	6ES7 398-8FA10-8DA0
Shielding connection clamps		Italian	6ES7 398-8FA10-8EA0
2 units			
For 2 cables with 2 mm to 6 mm diameter	6ES7 390-5AB00-0AA0		
For 1 cable with 3 mm to 8 mm diameter	6ES7 390-5BA00-0AA0		
For 1 cable with 4 mm to 13 mm diameter	6ES7 390-5CA00-0AA0		
Label cover	6ES7 392-2XY00-0AA0		
10 units (spare part), for modules with 20-pin front connector			
Labeling strips	6ES7 392-2XX00-0AA0		
10 units (spare part), for modules with 20-pin front connector			

A) Subject to export regulations: AL: N and ECCN: EAR99H

D) Subject to export regulations: AL: N and ECCN: 5D992B1

SIMATIC S7-300

Analog modules

SM 335 fast analog hybrid module

Application



The SM 335 fast analog input/output module converts

- Analog signals from the process into digital values for the SIMATIC S7-300 and
- Digital signals from the SIMATIC S7-300 into analog signals for the process.

In addition, the module can also supply encoders (e.g. linear potentiometers) with 10 V / 25 mA and has one counter input. Via the counter input it is possible, for example, to determine a speed, when the path length covered during the interval is known or the signals of simple rotating sensors can be recorded and the speed calculated by means of the interval duration.

4

Technical specifications

SM 335	
Module-specific data	
Number of inputs	4
Number of outputs	4
Cable length, shielded	200 m
With wire-break monitoring in range 0 V ... 10 V	30 m
Voltages, currents, potentials	
Rated load voltage	24 V DC
Polarity reversal protection	Yes
Galvanic isolation	Yes
Permissible potential difference	
• between inputs (U_{CM})	3 V
• between input (M terminal) and central grounding point	75 V DC
• Insulation	tested at 500 V DC
Current consumption	
• from S7-300 backplane bus, max.	75 mA
• from L+, max.	150 mA
Power losses, max.	3.6 W
Status, interrupts, diagnostics	
Interrupts	
• Limit value interrupt	No
• Cycle end interrupt	yes, parameterizable
• Diagnostics interrupt	yes, parameterizable
Diagnostic functions	
• Fault display for grouped fault	yes, red LED
• Diagnostic information can be read out	Yes
Analog value generation for inputs	
Measuring principle	successive approximation
Conversion time per channel	200 μ s
• Basic conversion time for 4 channels, max.	1 ms

SM 335	
Resolution	
• Bipolar	13 bits + sign
• Unipolar	14 Bit
Analog inputs	
Interference between inputs	
• at 50 Hz	65 dB
• at 60 Hz	65 dB
Operational limits (over entire temperature range, referred to input range)	
• with voltage measurement	$\pm 0.15\%$ (with 14-bit resolution)
• with current measurement	0.25%
Basic error limit (operational limits at 25 °C, referred to input range)	0.13% (with 14-bit resolution)
Temperature error (referred to input range)	$\pm 0.1\%$ (with 14-bit resolution)
Linearity error (referred to input range)	$\pm 0.015\%$
Repeatability (under steady-state conditions, at 25 °C, referred to input range)	$\pm 0.05\%$
Encoder selection data	
Input range (rated values)/input resistance	
• Voltage	± 1 V; ± 10 V; ± 2.5 V; 0 V ... 2 V; 0 V ... 10 V: 10 M Ω
• Current (max. 2 channels programmable as current inputs)	± 10 mA; 0 mA ... 20 mA; 4 mA ... 20 mA: 100 Ω
Permissible input voltage for voltage input (destruction limit)	± 30 V
Permissible input current for current input (destruction limit)	25 mA
Connection of signal encoder	
• for voltage measurement	possible
• for current measurement	
- as 2-wire transducer	not possible
- as 4-wire transducer	possible
• for resistance measurement	not possible

SIMATIC S7-300

Analog modules

SM 335 fast analog hybrid module

Technical specifications (continued)

SM 335	
Output for supplying the transducer (short-circuit proof)	10 V/25 mA
Data for encoder supply output	
Rated voltage	10 V
Output current, max.	25 mA
Short-circuit proof	Yes
Operating limits (over entire temperature range)	0.2%
Temperature error	0.002%/K
Basic error for rated voltage	0.1%
Outputs	
Resolution (including overcontrol range)	
• ± 10 V	11 bits + sign
• from 0 V ... 10 V	12 bits
Conversion time per channel, max.	800 µs
Settling time	
• for resistive load	< 0.1 ms
• for capacitive load	< 3.3 ms
• for inductive load	< 0.5 ms
Interference between outputs	40 dB
Substitute values can be switched in	Yes
Operational limits (over entire temperature range, referred to output range)	0.5%

SM 335	
Basic error limit (operational limits at 25 °C, referred to output range)	0.2%
Linearity error (referred to output range)	± 0.05%
Repeatability (under steady-state conditions, at 25 °C, referred to output range)	± 0.05%
Output ripple (referred to output range)	± 0.05%
Actuator selection data	
Input ranges (rated values)	± 10 V and 0 V ... 10 V (switchover)
Load impedance	
• for voltage outputs, min.	3 kΩ
• for capacitive load, max.	1 µF
• for inductive load, max.	1 mH
Voltage output	
• Short-circuit proof	Yes
• Short-circuit current, max.	8 mA
Connection of the actuators for voltage output	
• as 2-wire connection	possible
• as 4-wire connection	not possible
Dimensions and weight	
Dimensions (w x h x d)	40 mm x 125 mm x 120 mm
Weight, approx.	300 g

Ordering data

Ordering data	Order No.
SM 335 fast analog hybrid module 4 inputs, 4 outputs, 1 pulse input and encoder supply	6ES7 335-7HG01-0AB0
Interference suppressor filter for SM 335 to achieve the noise immunity common to SIMATIC S7; the filter is connected into the 24-V power supply circuit for the SM 335, and can protect up to four SM 335 modules	6ES7 335-7HG00-6AA0
SM 335 manual	
German	6ES7 335-7HG00-8AA1
English	6ES7 335-7HG00-8BA1

Ordering data	Order No.
Front connector 20-pin, with screw-type terminals	
• 1 unit	6ES7 392-1AJ00-0AA0
• 100 units	6ES7 392-1AJ00-1AB0
Shield connecting element 80 mm wide, with 2 rows for 4 shielding connection clamps each	6ES7 390-5AA00-0AA0
Shielding connection clamps 2 units	
For 2 cables with 2 mm to 6 mm diameter	6ES7 390-5AB00-0AA0
For 1 cable with 3 mm to 8 mm diameter	6ES7 390-5BA00-0AA0
For 1 cable with 4 mm to 13 mm diameter	6ES7 390-5CA00-0AA0

SIMATIC S7-300 SIPLUS analog modules

SIPLUS SM 331 analog input modules

www.DataSheet4U.com

Overview

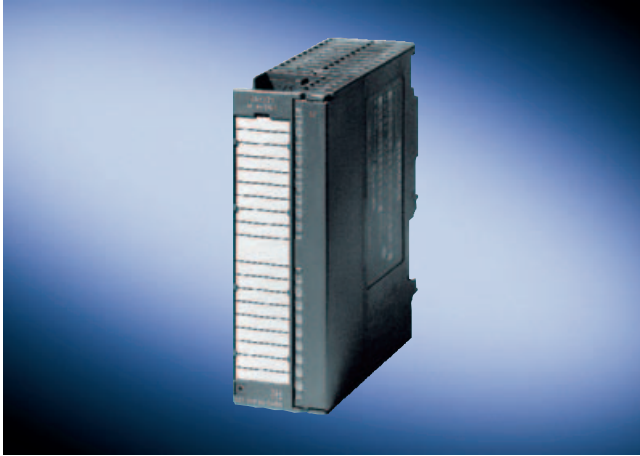

- Analog inputs
- For connection of voltage and current sensors, thermocouples, resistors and resistance thermometers

4

SIPLUS SM 321	2 AI	8 AI	8 AI, 16 bits	8 AI, 16 bits	8 AI, 40-pole
Order No.	6AG1 331-7KB02-2AB0	6AG1 331-7KF02-2AB0	6AG1 331-7NF00-2AB0	6AG1 331-7NF10-2AB0	6AG1 331-7PF01-2AB0
Order No. based on	6ES7 331-7KB02-0AB0	6ES7 331-7KF02-0AB0	6ES7 331-7NF00-0AB0	6ES7 331-7NF10-0AB0	6ES7 331-7PF01-0AB0
Ambient temperature range	-25 °C to +60 °C, condensation permissible				
Ambient conditions	Suitable for extraordinary medial load (for example by chloric and sulphuric atmospheres).				
Conformity with standard for electronic devices on rail vehicles (EN 50155, temperature T1, category 1)	Yes	No	Yes	No	No
Technical data	The technical data are identical with the technical data of the based on modules.				

Ordering data

SIPLUS SM 331 analog input modules

(extended temperature range and medial load)

Including labeling strips, bus connector, measuring range modules

2 inputs, resolution 9/12/14 bit A) **6AG1 331-7KB02-2AB0**

8 inputs, resolution 9/12/14 bit **6AG1 331-7KF02-2AB0**

8 inputs, enhanced resolution 16 bit A) **6AG1 331-7NF00-2AB0**

Order No.

SIPLUS SM 331 analog input modules

(extended temperature range and medial load)

Including labeling strips, bus connector, measuring range modules

8 inputs, enhanced resolution 16 bit, 4-channel mode A) **6AG1 331-7NF10-2AB0**

8 inputs, for thermal resistors A) **6AG1 331-7PF01-2AB0**

Accessories

see S7-300 analog input modules, page 4/118

Order No.

A) Subject to export regulations: AL: N and ECCN: EAR99H

SIMATIC S7-300

SIPLUS analog modules

SIPLUS SM 332 analog output modules

www.DataSheet4U.com

Overview



- Analog outputs
- For the connection of analog actuators

SIPLUS SM 321	2 AO	8 AO
Order No.	6AG1 332-5HB01-2AB0	6AG1 332-5HF00-2AB0
Order No. based on	6ES7 332-5HB01-0AB0	6ES7 332-5HF00-0AB0
Ambient temperature range	-25 °C to +60 °C, condensation permissible	
Ambient conditions	Suitable for extraordinary medial load (for example by chloric and sulphuric atmospheres).	
Conformity with standard for electronic devices on rail vehicles (EN 50155, temperature T1, category 1)	Yes	No
Technical specifications	The technical data are identical with the technical data of the based on modules.	

Ordering data	Order No.
SIPLUS SM 332 analog output modules	
(extended temperature range and medial load)	
incl. labeling strips, bus connector	
2 outputs, 11/12 bit	A) 6AG1 332-5HB01-2AB0
8 outputs, 11/12 bit	6AG1 332-5HF00-2AB0
Accessories	see S7-300 analog output modules, page 4/121

A) Subject to export regulations: AL: N and ECCN: EAR99H

SIMATIC S7-300 SIPLUS analog modules

SIPLUS SM 334 analog input/output module

www.DataSheet4U.com
Overview

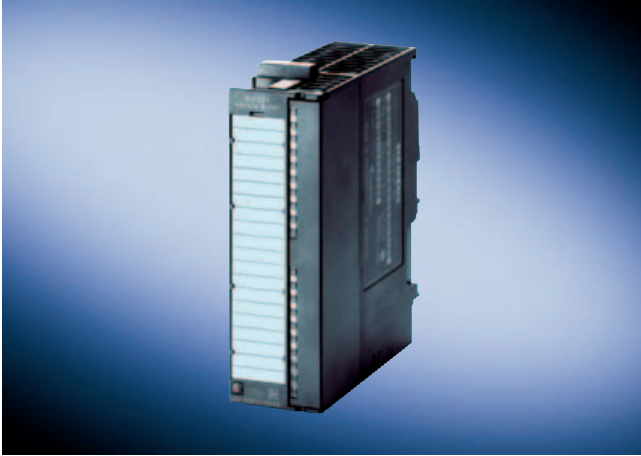

- Analog inputs and outputs
- For the connection of analog sensors and actuators

4

SIPLUS SM 334	4 AI/2 AO
Order No.	6AG1 334-0KE00-2AB0
Order No. based on	6ES7 334-0KE00-0AB0
Ambient temperature range	-25 °C to +60 °C, condensation permissible
Ambient conditions	Suitable for extraordinary medial load (for example by chloric and sulphuric atmospheres).
Technical data	The technical data are identical with the technical data of the based on modules.

Ordering data	Order No.
SIPLUS SM 334 analog input/output modules (extended temperature range and medial load) incl. labeling strips, bus connector 4 inputs, 2 outputs, resistance measurement, Pt 100	6AG1 334-0KE00-2AB0
Accessories	

A) Subject to export regulations: AL: N and ECCN: EAR99H

SIMATIC S7-300

F digital / analog modules

SM 326 F digital input module - Safety Integrated

www.DataSheet4U.com

Overview



- Digital inputs for the fail-safe SIMATIC S7 systems
- They are suitable for connecting:
 - switches and 2-wire proximity switches (BEROs)
 - Sensors according to NAMUR and mechanical contacts, also for signals from hazardous areas
- With integral safety functions for fail-safe operation
- Can be used in fail-safe mode
 - Centrally: With S7-31xF-2 DP
 - Distributed in ET 200M: With SIMATIC IM 151-7 F-CPU, S7-31xF-2 DP, S7-416F-2 and S7-400F/FH
- Can be used in standard mode as an S7-300 module

Technical specifications

	6ES7 326-1RF00-0AB0	6ES7 326-1BK01-0AB0
Supply voltages		
Supply voltage of electronics and encoders 1L+/2L+		
• Rated value (DC)	24 V	24 V
Current consumption		
from load voltage L+ (without load), max.	160 mA	450 mA
from backplane bus DC 5 V, max.	90 mA	100 mA
Power loss, typ.	4,5 W	10 W
Connection point		
required front connectors	40-pin	40-pin
Digital inputs		
Number of digital inputs	8; 8 (one-channel); 4 (two-channel)	24
Number of simultaneously controllable inputs		
• Number of simultaneously controllable inputs, up to 40 °C	8; vertical setup	24
• Number of simultaneously controllable inputs, up to 60 °C	8; horizontal set up	24; (at 24 V) or 18 (at 28.8 V)
Cable length		
• Cable length, shielded, max.	200 m	200 m
• Cable length unshielded, max.	100 m	100 m
Input voltage		
• Rated value, DC		24 V
• for signal "0"		-30V to 5 V
• for signal "1"		11 to 30 V
Input current		
• for signal "0", max. (permissible quiescent current)		2 mA
• for signal "1", typ.		10 mA

	6ES7 326-1RF00-0AB0	6ES7 326-1BK01-0AB0
Input delay (for rated value of input voltage)		
• for standard inputs		3.4 ms
- at "0" to "1", max.		3.4 ms
- at "1" to "0", max.		
Encoder supply		
Number of outputs	8	4; electrically isolated
Output voltage	DC 8,2 V	
Output current, rated value		400 mA
Encoder		
Connectable encoders		
• 2-wire BEROS		Yes; if short-circuit test is deactivated
• permissible quiescent current (2-wire BEROS), max.		2 mA
Ex(i) characteristics		
Module for Ex(i) protection	Yes	
Max. values of input circuits (per channel)		
• Co (permissible external capacity), max.	3 µF	
• Io (short-circuit current), max.	13.9 mA	
• Lo (permissible external inductivity), max.	80 mH	
• Po (power of load), max.	33.1 mW	
• Uo (output no-load voltage), max.	10 V	
• Ta (permissible ambient temperature), max.	60 °C	60 °C

SIMATIC S7-300

F digital / analog modules

SM 326 F digital input module - Safety Integrated

Technical specifications (continued)

	6ES7 326-1RF00-0AB0	6ES7 326-1BK01-0AB0
Status information/alarms/diagnostics		
Alarms		
• Diagnostic alarm	Yes	Yes
Diagnoses		
• Diagnostic information readable	Yes	Yes
Isolation		
Isolation checked with	500 V DC	500 V DC / 350 V AC
Isolation		
Galvanic isolation, digital inputs		
• between the channels	Yes	Yes
• between the channels, in groups of		12
• between the channels and the backplane bus	Yes	Yes

	6ES7 326-1RF00-0AB0	6ES7 326-1BK01-0AB0
Standards, approvals, certificates		
Type of protection to EN 50020 (CENELEC)	II(2)G [EEx ib] IIC to EN 50020	
Test number KEMA	99 ATEX 2671 X	
Highest safety class achievable in safety mode		
• to DIN VDE 0801	AK 4 (one channel), AK 5 und 6 (two channel)	AK 6
• to EN 954	Cat. 3 (single channel), Cat. 4 (two-channel)	Kat. 4
• to IEC 61508	SIL 2 (single channel), SIL 3 (two-channel)	SIL 3
Dimensions and weight		
Width	80 mm	80 mm
Height	125 mm	125 mm
Depth	120 mm	120 mm
Weights		
Weight, approx.	482 g	442 g

SIMATIC S7-300

F digital / analog modules

SM 326 F digital input module - Safety Integrated

4

www.DataSheet4U.com

Ordering data	Order No.	Order No.
SM 326 F digital input module 24 inputs, 24 V DC 8 inputs, 24 V DC, NAMUR	6ES7 326-1BK01-0AB0 6ES7 326-1RF00-0AB0	Active bus module BM 1 x 80 for 1 module with 80 mm width 6ES7 195-7HC00-0XA0
Distributed Safety V5.4 programming tool Task: Software for configuring fail-safe user programs for SIMATIC S7-300F, S7-400F, ET 200S Requirement: STEP 7 V5.3 SP3 and higher Floating license Software Update Service	6ES7 833-1FC02-0YA5 6ES7 833-1FC00-0YX2	SITOP power supply module for ET 200M; 120/230 V AC, 24 V DC, 5 A; Type PS 307-1E 6ES7 307-1EA00-0AA0
Distributed Safety Upgrade From V5.x to V5.4; Floating license for 1 user	6ES7 833-1FC02-0YE5	Front connector 40-pin, with screw contacts • 1 unit • 100 units 6ES7 392-1AM00-0AA0 6ES7 392-1AM00-1AB0 40-pin with cage clamp contacts • 1 unit • 100 units 6ES7 392-1BM01-0AA0 6ES7 392-1BM01-1AB0
Labeling sheet with strips for 10 electronic blocks • For 16-channel electronic blocks incl. add-on terminals • For 32-channel electronic blocks incl. add-on terminals	6ES7 193-1BH00-0XA0 6ES7 193-1BL00-0XA0	Labeling strips For fail-safe modules (spare part); 10 units 6ES7 392-2XX20-0AA0
Connecting cable for PROFIBUS 12 Mbit/s, for connecting PG to PROFIBUS DP, pre-assembled with 2 x 9-pin Sub-D connector, 3 m	6ES7 901-4BD00-0XA0	Label cover For fail-safe modules (spare part); 10 units 6ES7 392-2XY20-0AA0
PROFIBUS bus connector • 90° cable outlet, terminating resistor with isolating function, without PG socket, up to 12 Mbit/s • 90° cable outlet, terminating resistor with isolating function, without PG socket, up to 12 Mbit/s • Angular outgoing cable, insulation displacement terminals, without bus terminating resistor, without PG connection socket, up to 1.5 Mbit/s • 90° cable outlet, terminating resistor with isolating function, insulation displacement technology, Fast Connect, without PG socket, up to 12 Mbit/s • 90° cable outlet, terminating resistor with isolating function, insulation displacement technology, Fast Connect, with PG socket, up to 12 Mbit/s	6ES7 972-0BA12-0XA0 6ES7 972-0BB12-0XA0 6ES7 972-0BA30-0XA0 6ES7 972-0BA50-0XA0 6ES7 972-0BB50-0XA0	LK 393 cable guide For F modules; L+ and M connections; 5 units 6ES7 393-4AA10-0AA0
DIN rail for active bus modules for max. 5 active bus modules for hot swapping function • 483 mm long • 530 mm long • 620 mm long • 2000 mm long	6ES7 195-1GA00-0XA0 6ES7 195-1GF30-0XA0 6ES7 195-1GG30-0XA0 6ES7 195-1GC00-0XA0	S7-300 manual Design, CPU data, module data, instruction list German English French Spanish Italian 6ES7 398-8FA10-8AA0 6ES7 398-8FA10-8BA0 6ES7 398-8FA10-8CA0 6ES7 398-8FA10-8DA0 6ES7 398-8FA10-8EA0
		SIMATIC Manual Collection ^{D)} 6ES7 998-8XC01-8YE0 Electronic manuals on DVD, multilingual: S7-200, S7-300, C7, S7-400, SIMATIC DP (Distributed I/O), SIMATIC PC, SIMATIC PG (Programming device), STEP 7, Engineering Tools, Runtime Software, SIMATIC PCS 7, SIMATIC HMI (Human Machine Interface), SIMATIC NET (Industrial Communication), SIMATIC Machine Vision, SIMATIC Sensors
		SIMATIC Manual Collection update service for 1 year ^{D)} 6ES7 998-8XC01-8YE2 Current S7 Manual Collection DVD and the three subsequent updates

D) Subject to export regulations: AL: N and ECCN: 5D992B1

SIMATIC S7-300

F digital / analog modules

SM 326 F digital output module - Safety Integrated

www.DataSheet4U.com

Overview



- Digital outputs for the fail-safe SIMATIC S7 systems
- Two variants (1 x source/source output, 1 x source/sink output)
- For connection of solenoid valves, DC contactors and signaling lamps
- With integral safety functions for fail-safe operation
- Can be used in fail-safe mode
 - Centrally: With S7-31xF-2 DP
 - Distributed in ET 200M: With SIMATIC IM 151-7 F-CPU, S7-31xF-2 DP, S7-416F-2 and S7-400F/FH
- Can be used in standard mode as an S7-300 module (only applies to 6ES7 326-2BF01-0AB0)

4

Technical specifications

	6ES7 326-2BF01-0AB0	6ES7 326-2BF40-0AB0
Voltages and currents		
Load voltage L+		
• Rated value (DC)	24 V; 1L+, 2L+, 3L+	24 V; 1L+, 2L+, 3L+
Current consumption		
from load voltage 1L+, max.	70 mA; from supply voltage	75 mA; from supply voltage
from load voltage 2L+ (without load), max.	100 mA	100 mA
from load voltage 3L+ (without load), max.	100 mA	100 mA
from backplane bus DC 5 V, max.	100 mA	100 mA
Power loss, typ.	12 W	12 W
Connection point		
required front connectors	40-pin	40-pin
Digital outputs		
Number of digital outputs	10	8
Cable length, shielded, max.	1,000 m; 200 m for SIL3, AK 6, Cat 4	30 m
Cable length unshielded, max.	600 m	50 m
Short-circuit protection of the output	Yes; electronic	Yes; electronic
Limitation of inductive shutdown voltage to	L+ (-53 V) without series diode, L+ (-33 V) with series diode	L+ (-33 V)
Lamp load, max.	5 W	5 W
Output voltage		
• for signal "1" with series diode, min.	L+ (-1.8 V)	
• for signal "1" without series diode, min.	L+ (-1.0 V)	L+ (-1.0 V)

	6ES7 326-2BF01-0AB0	6ES7 326-2BF40-0AB0
Output current		
• for signal "1" rated value	2 A	2 A
• for signal "1" permissible range for 0 to 40 °C, min.	7 mA	7 mA
• for signal "1" permissible range for 0 to 40 °C, max.	2 A; 2 A for horizontal installation, 1 A for vertical installation	2 A; A for horizontal installation, 1 A for vertical installation
• for signal "1" permissible range for 40 to 60 °C, min.	7 mA	7 mA
• for signal "1" permissible range for 40 to 60 °C, max.	1 A; for horizontal installation	1 A; for horizontal installation
• for signal "0" residual current, max.	0.5 mA	0.5 mA
Switching frequency		
• with resistive load, max.	10 Hz	30 Hz
• with inductive load, max.	2 Hz	2 Hz
• on lamp load, max.	10 Hz	10 Hz
Aggregate current of the outputs (per group)		
• vertical installation - up to 40 °C, max.	5 A; without series diode, 4 A with series diode	5 A
• horizontal installation - up to 40 °C, max.	7.5 A; without series diode, 5 A with series diode	7.5 A
- up to 60 °C, max.	5 A; without series diode, 4 A with series diode	5 A

SIMATIC S7-300

F digital / analog modules

SM 326 F digital output module - Safety Integrated

Technical specifications (continued)

	6ES7 326-2BF01-0AB0	6ES7 326-2BF40-0AB0		6ES7 326-2BF01-0AB0	6ES7 326-2BF40-0AB0
Status information/alarms/diagnostics			Standards, approvals, certificates		
Alarms			Highest safety class achievable in safety mode		
• Diagnostic alarm	Yes	Yes; parameterizable	• to DIN VDE 0801	AK 5 and 6	
Diagnoses			• to EN 954	Cat. 4	Cat. 4
• Diagnostic information readable	Yes	Yes	• to IEC 61508	SIL 3	SIL 3
Isolation			Dimensions and weight		
Isolation checked with	500 V DC / 350 V AC	500 V DC / 350 V AC	Width	80 mm	80 mm
Isolation			Height	125 mm	125 mm
Isolation, digital outputs			Depth	120 mm	120 mm
• between the channels	Yes	Yes	Weights		
• between the channels, in groups of	5	4	Weight, approx.	465 g	465 g
• between the channels and the backplane bus	Yes	Yes			
• between the channels and the voltage supply to the electronics	Yes	Yes			

SIMATIC S7-300

F digital / analog modules

SM 326 F digital output module - Safety Integrated

4

Ordering data	Order No.	Order No.
SM 326 F digital output module 10 outputs, 24 V DC, 2 A 8 outputs, 24 V DC, 2 A	6ES7 326-2BF01-0AB0 6ES7 326-2BF40-0AB0	Active bus module BM 1 x 80 for 1 module with 80 mm width
Distributed Safety V5.4 programming tool Task: Software for configuring fail-safe user programs for SIMATIC S7-300F, S7-400F, ET 200S Requirement: STEP 7 V5.3 SP3 and higher Floating license Software Update Service	6ES7 833-1FC02-0YA5 6ES7 833-1FC00-0YX2	SITOP power supply module for ET 200M; 120/230 V AC, 24 V DC, 5 A Type PS 307-1E
Distributed Safety Upgrade From V5.x to V5.4; Floating license for 1 user	6ES7 833-1FC02-0YE5	Front connector 40-pin, with screw contacts • 1 unit • 100 units 40-pin with cage clamp contacts • 1 unit • 100 units
Labeling sheet with strips for 10 electronic blocks • For 16-channel electronic blocks incl. add-on terminals • For 32-channel electronic blocks incl. add-on terminals	6ES7 193-1BH00-0XA0 6ES7 193-1BL00-0XA0	Labeling strips For fail-safe modules (spare part), 10 units
Connecting cable for PROFIBUS 12 Mbit/s, for connecting PG to PROFIBUS DP, pre-assembled with 2 x 9-pin Sub-D connector, 3 m	6ES7 901-4BD00-0XA0	Label cover For fail-safe modules (spare part), 10 units
PROFIBUS bus connector • 90° cable outlet, terminating resistor with isolating function, without PG socket, up to 12 Mbit/s • 90° cable outlet, terminating resistor with isolating function, without PG socket, up to 12 Mbit/s • Angular outgoing cable, insulation displacement terminals, without bus terminating resistor, without PG connection socket, up to 1.5 Mbit/s • 90° cable outlet, terminating resistor with isolating function, insulation displacement technology, Fast Connect, without PG socket, up to 12 Mbit/s • 90° cable outlet, terminating resistor with isolating function, insulation displacement technology, Fast Connect, with PG socket, up to 12 Mbit/s	6ES7 972-0BA12-0XA0 6ES7 972-0BB12-0XA0 6ES7 972-0BA30-0XA0 6ES7 972-0BA50-0XA0 6ES7 972-0BB50-0XA0	LK 393 cable guide For F modules; L+ and M connections, 5 units
DIN rail for active bus modules for max. 5 active bus modules, for function "Insertion and removal" • 483 mm long • 530 mm long • 620 mm long • 2000 mm long	6ES7 195-1GA00-0XA0 6ES7 195-1GF30-0XA0 6ES7 195-1GG30-0XA0 6ES7 195-1GC00-0XA0	S7-300 manual Design, CPU data, module data, instruction list German English French Spanish Italian
		SIMATIC Manual Collection ^{D)} Electronic manuals on DVD, multilingual: S7-200, S7-300, C7, S7-400, SIMATIC DP (Distributed I/O), SIMATIC PC, SIMATIC PG (Programming device), STEP 7, Engineering Tools, Runtime Software, SIMATIC PCS 7, SIMATIC HMI (Human Machine Interface), SIMATIC NET (Industrial Communication), SIMATIC Machine Vision, SIMATIC Sensors
		SIMATIC Manual Collection update service for 1 year ^{D)} Current S7 Manual Collection DVD and the three subsequent updates

D) Subject to export regulations: AL: N and ECCN: 5D992B1

SIMATIC S7-300

F digital / analog modules

SM 336 F analog input module - Safety Integrated

www.DataSheet4U.com

Overview



- Analog inputs for the fail-safe SIMATIC S7 systems
- For connection of analog voltage and current sensors
- With integral safety functions for fail-safe operation
- For use in the ET 200M distributed I/O station with SIMATIC IM151-7 F-CPU, S7-31xF-2 DP, S7-416F-2 and S7-400F/FH
- Can be used in standard mode as an S7-300 module

Technical specifications

	6ES7 336-1HE00-0AB0
Voltages and currents	
Load voltage L+	
• Rated value (DC)	24 V
• reverse polarity protection	Yes
Current consumption	
from backplane bus DC 5 V, max.	90 mA
from supply voltage L+, max.	160 mA; typically
Power loss, typ.	4.25 W
Connection point	
required front connectors	40-pin
Analog inputs	
Number of analog inputs	6
Number of analog inputs for voltage measurement	4
Cable length, shielded, max.	200 m
permissible input frequency for voltage input (destruction limit), max.	30 V
permissible input current for current input (destruction limit), max.	40 mA
Input ranges (rated values), voltages	
• 0 to +10 V	Yes
Input ranges (rated values), currents	
• 0 to 20 mA	Yes
• 4 to 20 mA	Yes

	6ES7 336-1HE00-0AB0
Analog value creation	
Integrations and conversion time/resolution per channel	
• Resolution with overload area (bit including sign), max.	14 Bit
• Integration time, ms	20 ms (at 50 Hz); 16.66 ms (at 60 Hz)
• Interference voltage suppression for interference frequency f1 in Hz	38 dB
Encoder	
Connection of signal encoders	
• for current measurement as 2-wire transducer	Yes
• for current measurement as 4-wire transducer	Yes
Errors/accuracies	
Operational limit in overall temperature range	
• Voltage, relative to input area	+/- 0.48 %
• Current, relative to input area	+/- 0.48 %
Basic error limit (operational limit at 25 °C)	
• Voltage, relative to input area	+/- 0.4 %
• Current, relative to input area	+/- 0.4 %
Status information/alarms/diagnostics	
Alarms	
• Diagnostic alarm	Yes; parameterizable

SIMATIC S7-300

F digital / analog modules

SM 336 F analog input module - Safety Integrated

4

Technical specifications (continued)

6ES7 336-1HE00-0AB0		6ES7 336-1HE00-0AB0	
Diagnoses		Standards, approvals, certificates	
• Diagnostic information readable	Yes	Highest safety class achievable in safety mode	
Isolation		• to DIN V 19250	AK 6
Isolation checked with	500 V DC / 350 V AC	• to EN 954	Cat. 4
Isolation		• to IEC 61508	SIL 3
Isolation, analog inputs		Dimensions and weight	
• between the channels	No	Width	80 mm
• between the channels and the backplane bus	Yes	Height	125 mm
• between the channels and the voltage supply to the electronics	Yes; only if sensors are externally supplied	Depth	120 mm
		Weights	
		Weight, approx.	480 g

Ordering data	Order No.	Ordering data	Order No.
FM 336 F analog input module		PROFIBUS bus connector	
6 inputs, 14 bit	6ES7 336-1HE00-0AB0	• 90° cable outlet, terminating resistor with isolating function, without PG socket, up to 12 Mbit/s	6ES7 972-0BA12-0XA0
Distributed Safety V5.4 programming tool		• 90° cable outlet, terminating resistor with isolating function, without PG socket, up to 12 Mbit/s	6ES7 972-0BB12-0XA0
Task: Software for configuring fail-safe user programs for SIMATIC S7-300F, S7-400F, ET 200S		• Angular outgoing cable, insulation displacement terminals, without bus terminating resistor, without PG connection socket, up to 1.5 Mbit/s	6ES7 972-0BA30-0XA0
Requirement: STEP 7 V5.3 SP3 and higher		• 90° cable outlet, terminating resistor with isolating function, insulation displacement technology, Fast Connect, without PG socket, up to 12 Mbit/s	6ES7 972-0BA50-0XA0
Floating license	6ES7 833-1FC02-0YA5	• 90° cable outlet, terminating resistor with isolating function, insulation displacement technology, Fast Connect, with PG socket, up to 12 Mbit/s	6ES7 972-0BB50-0XA0
Software Update Service	6ES7 833-1FC00-0YX2	DIN rail for active bus modules	
Distributed Safety Upgrade		for max. 5 active bus modules for hot swapping function	
From V5.x to V5.4; Floating license for 1 user	6ES7 833-1FC02-0YE5	• 483 mm long	6ES7 195-1GA00-0XA0
Labeling sheet with strips for 10 electronic blocks		• 530 mm long	6ES7 195-1GF30-0XA0
• For 16-channel electronic blocks incl. add-on terminals	6ES7 193-1BH00-0XA0	• 620 mm long	6ES7 195-1GG30-0XA0
• For 32-channel electronic blocks incl. add-on terminals	6ES7 193-1BL00-0XA0	• 2000 mm long	6ES7 195-1GC00-0XA0
Connecting cable for PROFIBUS	6ES7 901-4BD00-0XA0		
12 Mbit/s, for connecting PG to PROFIBUS DP, pre-assembled with 2 x 9-pin Sub-D connector, 3 m			

SIMATIC S7-300

F digital / analog modules

SM 336 F analog input module - Safety Integrated

www.DataSheet4U.com

Ordering data	Order No.	Order No.
Active bus module BM 1 x 80 for 1 module with 80 mm width	6ES7 195-7HC00-0XA0	
SITOP power supply module for ET 200M; 120/230 V AC, 24 V DC, 5 A Type PS 307-1E	6ES7 307-1EA00-0AA0	
Front connector 40-pin, with screw contacts <ul style="list-style-type: none"> • 1 unit • 100 units 40-pin with cage clamp contacts <ul style="list-style-type: none"> • 1 unit • 100 units 	6ES7 392-1AM00-0AA0 6ES7 392-1AM00-1AB0 6ES7 392-1BM01-0AA0 6ES7 392-1BM01-1AB0	S7-300 manual Design, CPU data, module data, instruction list German English French Spanish Italian
Labeling strips For fail-safe modules (spare part), 10 units	6ES7 392-2XX20-0AA0	6ES7 398-8FA10-8AA0 6ES7 398-8FA10-8BA0 6ES7 398-8FA10-8CA0 6ES7 398-8FA10-8DA0 6ES7 398-8FA10-8EA0
Label cover For fail-safe modules (spare part), 10 units	6ES7 392-2XY20-0AA0	SIMATIC Manual Collection ^{D)} Electronic manuals on DVD, multilingual: S7-200, S7-300, C7, S7-400, SIMATIC DP (Distributed I/O), SIMATIC PC, SIMATIC PG (Programming device), STEP 7, Engineering Tools, Runtime Software, SIMATIC PCS 7, SIMATIC HMI (Human Machine Interface), SIMATIC NET (Industrial Communication), SIMATIC Machine Vision, SIMATIC Sensors
LK 393 cable guide For F modules; L+ and M connections, 5 units	6ES7 393-4AA10-0AA0	SIMATIC Manual Collection update service for 1 year ^{D)} Current S7 Manual Collection DVD and the three subsequent updates

D) Subject to export regulations: AL: N and ECCN: 5D992B1

Isolation module

Overview

See section 5, SIMATIC S7-400, page 5/101

SIMATIC S7-300

SIPLUS F digital-/analog modules

**SIPLUS SM 326 F digital input module -
Safety Integrated**

www.DataSheet4U.com
Overview



- Digital inputs for the fail-safe SIMATIC S7 systems
- They are suitable for connecting:
 - switches and 2-wire proximity switches (BEROs)
 - Sensors according to NAMUR and mechanical contacts, also for signals from hazardous areas
- With integral safety functions for fail-safe operation
- Can be used in fail-safe mode
 - Centrally: With S7-31xF-2 DP
 - Distributed in ET 200M: With SIMATIC IM 151-7 F-CPU, S7-31xF-2 DP, S7-416F-2 and S7-400F/FH
- Can be used in standard mode as an S7-300 module

4

Fail-safe digital output module	SIPLUS SM 326
Order No.	6AG1 326-1BK01-2AB0
Order No. based on	6ES7 326-1BK01-0AB0
Ambient temperature range	-25 °C to +60 °C, condensation permissible
Ambient conditions	Suitable for extraordinary medial load (for example by chloric and sulphuric atmospheres).
Technical data	The technical data are identical with the technical data of the based on modules.

Ordering data	Order No.
SIPLUS SM 326 F digital input module	
(extended temperature range and medial load)	
24 inputs, 24 V DC	
Accessories	see S7-300 F digital input modules, page 4/132

SIMATIC S7-300

SIPLUS F digital-/analog modules

SIPLUS SM 326 F digital output module - Safety Integrated

www.DataSheet4U.com

Overview



- Digital outputs for the fail-safe SIMATIC S7 systems
- Two variants (1 x source/source output, 1 x source/sink output)
- For connection of solenoid valves, DC contactors and signaling lamps
- With integral safety functions for fail-safe operation
- Can be used in fail-safe mode
 - Centrally: With S7-31xF-2 DP
 - Distributed in ET 200M: With SIMATIC IM 151-7 F-CPU, S7-31xF-2 DP, S7-416F-2 and S7-400F/FH
- Can be used in standard mode as an S7-300 module (only applies to 6ES7 326-2BF01-0AB0)

SIPLUS SM 326 fail-safe digital output module

Order No.	6AG1 326-2BF01-2AB0
Order No. based on	6ES7 326-2BF01-0AB0
Ambient temperature range	-25 °C to +60 °C, condensation permissible
Ambient conditions	Suitable for extraordinary medial load (for example by chloric and sulphuric atmospheres).
Conformity with standard for electronic devices on rail vehicles (EN 50155, temperature T1, category 1).	Yes
Technical data	The technical data are identical with the technical data of the based on modules.

Ordering data

Order No.

SIPLUS SM 326 F digital output module

(extended temperature range and medial load)

10 outputs, 24 V DC, 2 A

Accessories

6AG1 326-2BF01-2AB0

see S7-300 F digital output modules, page 4/135

SIPLUS Isolation module

Overview

See section 5, SIMATIC S7-400, page 5/102

SIMATIC S7-300

Ex digital input/output modules

Ex digital input/output modules

4

Overview

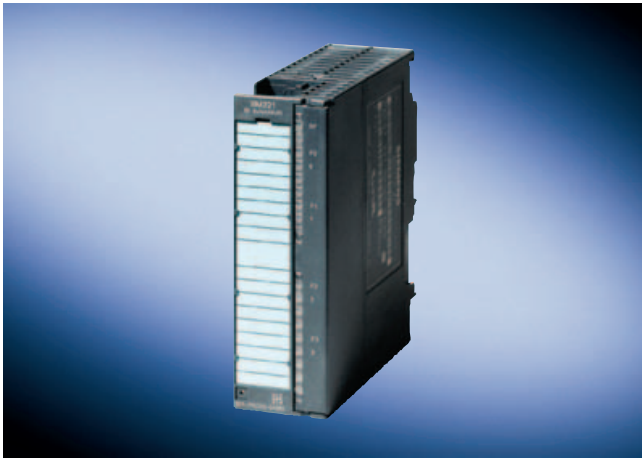

- I/O modules for applications within potentially explosive chemical plants
- For connecting sensors and actuators from zones 1 and 2 in hazardous area installations
- Associated electrical equipment [EEx ib] IIC in accordance with DIN 50020
- For isolating non-intrinsically safe circuits of the programmable logic controller and the intrinsically safe circuits from the process

Technical specifications

	6ES7 321-7RD00-0AB0
Voltages and currents	
Load voltage L+	
• Rated value (DC)	24 V
Current consumption	
from load voltage L+ (without load), max.	50 mA
from backplane bus DC 5 V, max.	80 mA
Power loss, typ.	1.1 W
Connection point	
required front connectors	20-pin
Digital inputs	
Number of NAMUR inputs	4
Cable length	
• Cable length unshielded, max.	200 m
Input voltage	
• Rated value, DC	8.2 V; from internal power circuit supply
Input current	
• on wire break, max.	0.1 mA
• on short-circuit, max.	8.5 mA
• for NAMUR encoders	
- for signal "0"	0.35 to 1.2 mA
- for signal "1"	2.1 to 7 mA
Input delay (for rated value of input voltage)	
• Input frequency (with 0.1 ms delay), max.	2 kHz
• for NAMUR inputs	
- programmable	Yes; 0.1 / 0.5 / 3 / 15 / 20 ms (plus 0.25 ms preparation time)
Encoder supply	
Output voltage	via the inputs

	6ES7 321-7RD00-0AB0
Encoder	
Connectable encoders	
• NAMUR encoder	Yes; Two-wire connection
Ex(i) characteristics	
Max. values of input circuits (per channel)	
• Co (permissible external capacity), max.	3 µF
• Io (short-circuit current), max.	14.1 mA
• Lo (permissible external inductivity), max.	100 mH
• Po (power of load), max.	33.7 mW
• Uo (output no-load voltage), max.	10 V
Status information/alarms/diagnostics	
Diagnoses	
• Diagnostic information readable	Yes
Isolation	
Galvanic isolation, digital inputs	
• galvanic isolation, digital inputs	Yes
• between the channels, in groups of	1
Standards, approvals, certificates	
Type of protection to EN 50020 (CENELEC)	[EEx ib] IIC
Type of protection to FM	CL.2, DIV 2, GP A,B,C,D T4
Test number PTB	Ex-96.D.2094X
Weights	
Weight, approx.	230 g

SIMATIC S7-300

Ex digital input/output modules

Ex digital input/output modules

Technical specifications (continued)

	6ES7 322-5SD00-0AB0	6ES7 322-5RD00-0AB0
Voltages and currents		
Load voltage L+		
• Rated value (DC)	24 V	24 V
Current consumption		
from load voltage L+ (without load), max.	160 mA	160 mA
from backplane bus DC 5 V, max.	70 mA	70 mA
Power loss, typ.	3 W	3 W
Connection point		
required front connectors	20-pin	20-pin
Digital outputs		
Number of digital outputs	4	4
Cable length unshielded, max.	200 m	200 m
Short-circuit protection of the output	Yes; electronic	Yes; electronic
• Response threshold, typ.	Output current with short-circuit protection, min. 10 mA + 10 %	Output current with short-circuit protection, min. 20.5 mA + 10 %
Output voltage		
• Rated value (DC)	24 V	15 V
Output current		
• for signal "1" permissible range for 0 to 60 °C, max.	10 mA; +/- 10%	20 mA; +/- 10%
Switching frequency		
• with resistive load, max.	100 Hz	100 Hz
Load impedance range		
• upper limit	390 Ω; Two-wire connection	200 Ω; Two-wire connection

	6ES7 322-5SD00-0AB0	6ES7 322-5RD00-0AB0
Ex(i) characteristics		
Max. values of output circuits (per channel)		
• Co (permissible external capacity), max.	90 nF	500 nF
• Io (short-circuit current), max.	70 mA	85 mA
• Lo (permissible external inductivity), max.	6.7 mH	5 mH
• Po (power of load), max.	440 mW	335 mW
• Uo (output no-load voltage), max.	25.2 V	15.75 V
Status information/alarms/diagnostics		
Diagnoses		
• Diagnostic information readable	Yes	Yes
• Short circuit	Yes	Yes
• Group error	Yes	Yes
Isolation		
Isolation, digital outputs		
• Galvanic isolation, digital outputs	Yes	Yes
• between the channels, in groups of	1	1
Type of protection to EN 50020 (CENELEC)		
Type of protection to FM	[EEx ib] IIC	[EEx ib] IIC
Test number PTB		
	CL 1, DIV 2, GP A,B,C,D T4	AIS CL.1, DIV 1, GP A,B,C,D; CL.1, DIV 2, GP A,B,C,D T4
Weights		
Weight, approx.		
Type of protection to EN 50020 (CENELEC)	230 g	230 g

SIMATIC S7-300

Ex digital input/output modules

Ex digital input/output modules

Ordering data	Order No.	Order No.
Ex digital input module 4 inputs, isolated, NAMUR	6ES7 321-7RD00-0AB0	
Ex digital output modules 4 outputs, isolated, 24 V DC, 10 mA	6ES7 322-5SD00-0AB0	
4 outputs, isolated, 15 V DC, 20 mA	6ES7 322-5RD00-0AB0	
Front connectors 20-pin, with screw contacts		
• 1 piece	6ES7 392-1AJ00-0AA0	
• 100 pieces	6ES7 392-1AJ00-1AB0	
Front door, elevated design e.g. for 32 channel modules; enables connection of 1.3 mm ² /16 AWG wires	A) 6ES7 328-0AA00-7AA0	
LK 393 cable guide Mandatory for operation in Ex-hazard areas	6ES7 393-4AA00-0AA0	
Labeling strips 10 pieces (spare part), for modules with 20-pin front connector	6ES7 392-2XX00-0AA0	
Label cover 10 pieces (spare part), for modules with 20-pin front connector	6ES7 392-2XY00-0AA0	
S7 SmartLabel Software for automatic labeling of modules based on data of the STEP 7 project	2XV9 450-1SL01-0YX0	
		Labeling sheets for machine inscription
		For 16-channel signal modules, DIN A4, for printing with laser printer; 10 pieces
		petrol
		light-beige
		yellow
		red
		SIMATIC Manual Collection D)
		Electronic manuals on DVD, multilingual: S7-200, S7-300, C7, S7-400, SIMATIC DP (Distributed I/O), SIMATIC PC, SIMATIC PG, STEP 7, Engineering Tools, Runtime Software, SIMATIC PCS 7, SIMATIC HMI (Human Machine Interface), SIMATIC NET (Industrial Communication), SIMATIC Machine Vision, SIMATIC Sensors
		SIMATIC Manual Collection update service for 1 year D)
		Current S7 Manual Collection DVD and the three subsequent updates
		Reference manual Ex I/O station S7-300, ET 200M
		German
		English
		6ES7 392-2AX00-0AA0
		6ES7 392-2BX00-0AA0
		6ES7 392-2CX00-0AA0
		6ES7 392-2DX00-0AA0
		6ES7 998-8XC01-8YE0
		6ES7 998-8XC01-8YE2
		6ES7 398-8RA00-8AA0
		6ES7 398-8RA00-8BA0

A) Subject to export regulations: AL: N and ECCN: EAR99H

D) Subject to export regulations: AL: N and ECCN: 5D992B1

SIMATIC S7-300

Ex digital input/output modules

Ex analog input/output modules

www.DataSheet4U.com

Overview



- I/O modules for applications within potentially explosive chemical plants
- For connecting sensors and actuators from zones 1 and 2 in hazardous area installations
- Associated electrical equipment [EEx ib] IIC in accordance with DIN 50020
- For isolation of non-IS circuits of the automation system and the IS circuits from the process

Technical specifications

	6ES7 331-7RD00-0AB0	6ES7 331-7SF00-0AB0
Voltages and currents		
Load voltage L+		
• Rated value (DC)	24 V	24 V
Voltage supply to the transducers		
• present	Yes	
• Rated value (DC)	13 V; at 22 mA	
• No-load voltage (DC)	25.2 V	
Current consumption		
from backplane bus DC 5 V, max.	60 mA	120 mA
from supply voltage L+, max.	150 mA	
Power loss, typ.	3 W	0,6 W
Connection point		
required front connectors	20-pin	20-pin
Analog inputs		
Number of analog inputs	4	8; 8 x thermocouples, 4 x RTD thermistors
Cable length, shielded, max.	200 m	200 m; HTC:50 m
permissible input current for current input (destruction limit), max.	40 mA	
Input ranges (rated values), currents		
• 0 to 20 mA	Yes	
• 4 to 20 mA	Yes	
Input ranges (rated values), thermoelements		
• Type B		Yes
• Type E		Yes
• Type J		Yes
• Type K		Yes

	6ES7 331-7RD00-0AB0	6ES7 331-7SF00-0AB0
Input ranges (rated values), thermoelements		
• Type L		Yes
• Type N		Yes
• Type R		Yes
• Type S		Yes
• Type T		Yes
• Type U		Yes
Input ranges (rated values), resistance thermometers		
• Ni 100		Yes
• Pt 100		Yes
• Pt 200		Yes
Analog value creation		
Measurement principle	SIGMA-DELTA	SIGMA-DELTA
Integrations and conversion time/ resolution per channel		
• Resolution with overload area (bit including sign), max.	16 Bit; 10 to 15 bit + sign	16 Bit; 10 to 15 bit + sign
• Integration time, parameterizable	Yes; 2.5 to 100 ms	Yes; 2.5 to 100 ms
• Interference voltage suppression for interference frequency f1 in Hz	10 to 400 Hz	10 to 400 Hz
Encoder		
Connection of signal encoders		
• for current measurement as 2-wire transducer	Yes	Yes
• for current measurement as 4-wire transducer	Yes	Yes

SIMATIC S7-300

Ex digital input/output modules

Ex analog input/output modules

4

Technical specifications (continued)

	6ES7 331-7RD00-0AB0	6ES7 331-7SF00-0AB0
Ex(i) characteristics		
Max. values of input circuits (per channel)		
<ul style="list-style-type: none"> Co (permissible external capacity), max. Io (short-circuit current), Lo (permissible external inductivity), max. Po (power of load), max. Ri, max. Uo (output no-load voltage), max. 	90 nF 68.5 mA 7.5 mH 431 mW 50 Ω 25.2 V	60 μF 28.8 mA 40 mH 41.4 mW 5.9 V
Errors/accuracies		
Operational limit in overall temperature range		
<ul style="list-style-type: none"> Current, relative to input area 	+/- 0.45 %	
Basic error limit (operational limit at 25 °C)		
<ul style="list-style-type: none"> Current, relative to input area Resistance-type thermometer, relative to input area 	+/- 0.1 %	+/- 0.1 %
Interference voltage suppression for $f = n \times (f_l \pm 1 \%)$, f_l = interference frequency		
<ul style="list-style-type: none"> Series mode interference (peak value of interference < rated value of input range), min. common mode voltage, min. 	60 dB 130 dB	60 dB 130 dB
Status information/alarms/diagnostics		
Diagnoses		
<ul style="list-style-type: none"> Diagnostic information readable Overrange Wire break in signal encoder cable Short circuit of the signal encoder cable 	Yes Yes Yes Yes	Yes Yes Yes Yes
Isolation		
Isolation, analog inputs		
<ul style="list-style-type: none"> Isolation, analog inputs 	Yes	Yes

	6ES7 331-7RD00-0AB0	6ES7 331-7SF00-0AB0
Permissible potential difference		
between the inputs (UCM)	60 V DC	60 V DC
between inputs and MANA (UCM)	60 V DC	60 V DC
Standards, approvals, certificates		
Type of protection to EN 50020 (CENELEC)	[EEx ib] IIC	[EEx ib] IIC
Type of protection to FM	CL.I, DIV 2, GPA,B,C,D T4	CL.I, DIV 2, GPA,B,C,D T4
Test number PTB	Ex-96.D.2092X	Ex-96.D.2108X
Weights		
Weight, approx.	290 g	210 g
6ES7 332-5RD00-0AB0		
Voltages and currents		
Load voltage L+		
<ul style="list-style-type: none"> Rated value (DC) 	24 V	
Current consumption		
from load voltage L+ (without load), max.	180 mA	
from backplane bus DC 5 V, max.	80 mA	
Power loss, typ.	4 W	
Connection point		
required front connectors	20-pin	
Analog outputs		
Number of analog outputs	4	
Cable length, shielded, max.	200 m	
Voltage output, short-circuit protection	Yes	
Voltage output, short-circuit current, max..	70 mA	
Current output, no-load voltage, max.	14 V	
Output ranges, current		
<ul style="list-style-type: none"> 0 to 20 mA 4 to 20 mA 	Yes Yes	
Connection of actuators		
<ul style="list-style-type: none"> for current output 2-conductor connection 	Yes	
Load impedance (in rated range of output)		
<ul style="list-style-type: none"> with current outputs, max. 	500 Ω	
Analog value creation		
Integrations and conversion time/resolution per channel		
<ul style="list-style-type: none"> Resolution with overload area (bit including sign), max. Basic conversion time, ms 	15 Bit 2.5 ms	

SIMATIC S7-300

Ex digital input/output modules

Ex analog input/output modules

Technical specifications (continued)

	6ES7 332-5RD00-0AB0
Ex(i) characteristics	
Max. values of output circuits (per channel)	
• Co (permissible external capacity), max.	850 nF
• Io (short-circuit current), max.	70 mA
• Lo (permissible external inductivity), max.	6.6 mH
• Po (power of load), max.	440 mW
• Uo (output no-load voltage), max.	14 V
Errors/accuracies	
Operational limit in overall temperature range	
• Current, relative to output area	+/- 0.55 %
Basic error limit (operational limit at 25 °C)	
• Current, relative to output area	+/- 0.2 %

	6ES7 332-5RD00-0AB0
Status information/alarms/diagnostics	
Diagnoses	
• Diagnostic information readable	Yes
• Overrange	Yes
• Wire break in actuator cable	Yes
• Group error	Yes
Isolation	
Isolation, analog outputs	
• Galvanic isolation, analog outputs	Yes
Permissible potential difference	
between outputs and MANA (UCM)	DC 60 V / AC 30 V
between the outputs (UCM)	DC 60 V / AC 30 V
Standards, approvals, certificates	
Type of protection to EN 50020 (CENELEC)	[Ex ib] IIC
Type of protection to FM	CL.I, DIV 2, GP A,B,C,D T4
Test number PTB	Ex-96.D.2026X
Weights	
Weight, approx.	280 g

Ordering data	Order No.
Ex analog input modules	
4 inputs, isolated, 0/4 to 20 mA, 15 bit	6ES7 331-7RD00-0AB0
8/4 inputs, isolated, for thermo-couples and Pt100, Pt200, Ni100	6ES7 331-7SF00-0AB0
Ex analog output module	
4 outputs, isolated, 0/4 to 20 mA	6ES7 332-5RD00-0AB0
Front connectors	
20-pin, with screw contacts	
• 1 piece	6ES7 392-1AJ00-0AA0
• 100 pieces	6ES7 392-1AJ00-1AB0
Front door, elevated design	
e.g. for 32 channel modules; enables connection of 1.3 mm ² /16 AWG wires	A) 6ES7 328-0AA00-7AA0
LK 393 cable guide	6ES7 393-4AA00-0AA0
Mandatory for operation in Ex-hazard areas	
Labeling strips	6ES7 392-2XX00-0AA0
10 pieces (spare part), for modules with 20-pin front connector	

Ordering data	Order No.
Label cover	6ES7 392-2XY00-0AA0
10 pieces (spare part), for modules with 20-pin front connector	
S7 SmartLabel	2XV9 450-1SL01-0YX0
Software for automatic labeling of modules based on data of the STEP 7 project	
Labeling sheets for machine inscription	
For 16-channel signal modules, DIN A4, for printing with laser printer; 10 pieces	
petrol	6ES7 392-2AX00-0AA0
light-beige	6ES7 392-2BX00-0AA0
yellow	6ES7 392-2CX00-0AA0
red	6ES7 392-2DX00-0AA0
SIMATIC Manual Collection D)	6ES7 998-8XC01-8YE0
SIMATIC Manual Collection update service for 1 year D)	6ES7 998-8XC01-8YE2
Reference manual Ex-Peripherals S7-300, ET 200M	
German	6ES7 398-8RA00-8AA0
English	6ES7 398-8RA00-8BA0

A) Subject to export regulations: AL: N and ECCN: EAR99H

D) Subject to export regulations: AL: N and ECCN: 5D992B1

SIMATIC S7-300

Function modules

FM 350-1 counter module

4

www.DataSheet4U.com

Overview



- One-channel intelligent counter module for simple counting tasks
- For direct connection of incremental encoders
- Comparison function with 2 specifiable comparison values
- Integrated digital outputs to output the response upon reaching the comparison value.
- Operating modes:
 - Continuous counting
 - One-shot counting
 - Periodic counting
- Special functions:
 - Set counter
 - Latch counter
- Start/stop counter with gate function

Note:

Incremental encoders and pre-assembled connecting cables for counting and positioning functions are offered under SIMODRIVE Sensor or Motion Connect 500.

Additional information is available in the Internet under:

<http://www.siemens.com/simatic-technology>

Technical specifications

	6ES7 350-1AH03-0AE0
Voltages and currents	
Aux. voltage 1L+, load voltage 2 L+	
• Rated value (DC)	24 V
• Permissible range (ripple included)	
- dynamic, lower limit (DC)	18.5 V
- dynamic, upper limit (DC)	30.2 V
- static, lower limit (DC)	20.4 V
- static, upper limit (DC)	28.8 V
• non-periodic skip	
- Duration	500 ms
- Recovery time	50 s
- Value	35 V
Current consumption	
from load voltage 1L+ (without load), max.	40 mA
from backplane bus DC 5 V, max.	160 mA
Power loss, typ.	4.5 W
Connection point	
required front connectors	1 x 20-pin
Digital inputs	
Number of digital inputs	3
Functions	1 for gate start, 1 for gate stop, 1 for setting the counter
Input voltage	
• for signal "0"	-28.8 to 5 V
• for signal "1"	+11 to +28.8 V
Input current	
• for signal "1", typ.	9 mA

	6ES7 350-1AH03-0AE0
Digital outputs	
Number of digital outputs	2
Short-circuit protection of the output	Yes; clocked electronically
Limitation of inductive shutdown voltage to	2L+ (-39 V)
Output voltage	
• for signal "0" (DC), max.	3 V
• for signal "1", min.	2L+ (-1,5 V)
Output current	
• for signal "1" rated value	0.5 A
• for signal "1" permissible range for 0 to 60 °C, min.	5 mA
• for signal "1" permissible range for 0 to 60 °C, max.	0.6 A
Output delay with resistive load	
• "0" to "1", max.	300 µs
Encoder supply	
5 V encoder supply	
• 5 V	Yes; 5.2 V +/-2%
• Output current, max.	300 mA
24 V encoder supply	
• 24 V	Yes; 1L+ (-3V)
• Output current, max.	400 mA
Encoder	
Connectable encoders	
• Incremental encoder (symmetrical)	Yes; with 2 pulse series offset by 90°
• Incremental encoder (asymmetrical)	Yes
• 24 V initiator	Yes
• 24 V directional element	Yes; 1 pulse train, 1 direction

SIMATIC S7-300

Function modules

FM 350-1 counter module

Technical specifications (continued)

	6ES7 350-1AH03-0AE0
Counters	
Number of counter inputs	1
Counting range, description	32 bit or +/-31 bit
Minimum pulse width, adjustable	Yes; 2.5 µs or 25 µs
Counter input 5 V	
• Type	RS 422
• Terminating resistor	220 Ω
• Differential input voltage	1.3 V
• Counter frequency, max.	500 kHz
Counter input 24 V	
• Input voltage, for signal "0"	-28.8 to +5 V
• Input voltage, for signal "1"	+11 to +28.8 V
• Input current, for signal "1", typ.	9 mA
• Counter frequency, max.	200 kHz
• Minimum pulse width	2.5 µs
Isolation	
Isolation checked with	500 V

	6ES7 350-1AH03-0AE0
Isolation	
Isolation, digital outputs	
• between the channels and the backplane bus	Yes; Optocoupler
Galvanic isolation, digital inputs	
• between the channels and the backplane bus	Yes; Optocoupler
Isolation counter	
• between the channels and the backplane bus	Yes; Optocoupler
Permissible potential difference	
between different circuits	500 V DC
Dimensions and weight	
Width	40 mm
Height	125 mm
Depth	120 mm
Weights	
Weight, approx.	250 g

SIMATIC S7-300

Function modules

FM 350-1 counter module

Ordering data	Order No.	Order No.
FM 350-1 counter module with 1 channel, max. 500 kHz; for incremental encoder	6ES7 350-1AH03-0AE0	Refer to A&D Mall under SIMODRIVE Sensor or Motion Connect 500 (see also www.siemens.com/ simatic-technology)
Coding plug - Range card for analog inputs Spare part	6ES7 974-0AA00-0AA0	
Front connector 20-pin, with screw contacts		
• 1 unit	6ES7 392-1AJ00-0AA0	
• 100 units	6ES7 392-1AJ00-1AB0	
20-pin, with cage clamp terminals		
• 1 unit	6ES7 392-1BJ00-0AA0	
• 100 units	6ES7 392-1BJ00-1AB0	
Bus connectors 1 piece (spare part)	6ES7 390-0AA00-0AA0	
Labeling strips 10 pieces (spare part)	6ES7 392-2XX00-0AA0	
S7 SmartLabel Software for automatic labeling of modules based on data of the STEP 7 project	2XV9 450-1SL01-0YX0	
Labeling sheets for machine inscription	See "Accessories", page 4/240	
Slot number label Spare part	6ES7 912-0AA00-0AA0	
Shield connection element 80 mm wide, with 2 rows for 4 terminals each	6ES7 390-5AA00-0AA0	
Terminal elements 2 pieces		
For 2 cables with 2 mm to 6 mm diameter	6ES7 390-5AB00-0AA0	
For 1 cable with 3 mm to 8 mm diameter	6ES7 390-5BA00-0AA0	
For 1 cable with 4 mm to 13 mm diameter	6ES7 390-5CA00-0AA0	
Connectable incremental encoder 6FX2 001-2...		
Signal cable Preassembled for HTL and TTL encoder, without Sub-D connector, UL/DESINA		6 FX5 002 - 2 CA12 - 000
Length code:		1 2 3
0 m		A
100 m		B
200 m		C
0 m		D
10 m		E
20 m		F
30 m		G
40 m		H
50 m		J
60 m		K
70 m		A
80 m		B
90 m		C
0 m		D
1 m		E
2 m		F
3 m		G
4 m		H
5 m		J
6 m		K
7 m		
8 m		
9 m		

SIMATIC S7-300

Function modules

FM 350-2 counter module

www.DataSheet4U.com

Overview



- 8-channel intelligent counter module for universal counter and measurement tasks
- For direct connection of 24 V incremental encoders, directional elements, initiators or NAMUR sensors
- Compare function with programmable comparison values (number depends on operating mode).
- Integrated digital outputs to output the response upon reaching the comparison value.
- Operating modes:
 - Continuous/one-shot/periodic counting
 - Frequency/speed control
 - Period measurement
 - Proportioning

Note:

SIMODRIVE Sensor/Motion Connect 500 feature incremental encoders and preassembled connecting cables for counting and positioning functions.

Additional information is available in the Internet under:

<http://www.siemens.com/simatic-technology>

Technical specifications

	6ES7 350-2AH00-0AE0
Voltages and currents	
Aux. voltage 1L+, load voltage 2 L+	
• Rated value (DC)	24 V
• permissible range, lower limit (DC)	20.4 V
• permissible range, upper limit (DC)	28.8 V
Current consumption	
from load voltage L+ (without load), max.	150 mA
from backplane bus DC 5 V, max.	100 mA
Power loss, typ.	10 W
Connection point	
required front connectors	1 x 40-pin
Digital inputs	
Number of digital inputs	8
Functions	1 each for gate start/ gate stop
Cable length	
• Cable length, shielded, max.	100 m
Input voltage	
• for signal "0"	-3 to 5 V
• for signal "1"	11 to 30.2 V
Input current	
• for signal "0", max. (permissible quiescent current)	2 mA
• for signal "1", typ.	9 mA
Input delay (for rated value of input voltage)	
• for standard inputs - at "0" to "1", max.	50 µs

	6ES7 350-2AH00-0AE0
Digital outputs	
Number of digital outputs	8
Cable length, shielded, max.	600 m
Cable length unshielded, max.	100 m
Short-circuit protection of the output	Yes
Limitation of inductive shutdown voltage to	L+ (-40 V)
Output voltage	
• for signal "1", min.	L+ (-0,8 V)
Output current	
• for signal "1" rated value	0.5 A
• for signal "0" residual current, max.	0.5 mA
Output delay with resistive load	
• "0" to "1", max.	300 µs
Switching frequency	
• with resistive load, max.	500 Hz
• with inductive load, max.	0.5 Hz
Aggregate current of the outputs (per group)	
• horizontal installation - up to 40 °C, max.	4 A
- up to 60 °C, max.	2 A
• all other mounting positions - up to 40 °C, max.	2 A
Encoder supply	
Output voltage	NAMUR-encoder supply: 8.2 V +/-2%
Output current, rated value	200 mA
Short-circuit protection	Yes

SIMATIC S7-300

Function modules

FM 350-2 counter module

4

Technical specifications (continued)

	6ES7 350-2AH00-0AE0
Encoder	
Connectable encoders	
• Incremental encoder (asymmetrical)	Yes
• 24 V initiator	Yes
• 24 V directional element	Yes
• NAMUR encoder	Yes
• 2-wire BEROS	Yes
NAMUR encoder	
• Number of NAMUR inputs	8
• Input signal	to DIN 19 234
• Input current, for signal "0", max.	1.2 mA
• Input current, for signal "1", min.	2.1 mA
• Input delay, max.	50 µs
• Input frequency, max.	20 kHz
• Cable length, shielded, max.	100 m
Counters	
Counter input 24 V	
• Number	8; 32 bit or +/-31 bit
• Input voltage, for signal "0"	-3 to 5 V
• Input voltage, for signal "1"	11 V to 30.2 V
• Input current, for signal "0", max.. (permissible idle current)	2 mA
• Input current, for signal "1", typ.	9 mA
• Input delay, max.,	50 µs

	6ES7 350-2AH00-0AE0
• Counter frequency, max.	20 kHz; 24 V incremental encoder: 10 kHz.; 24 V directional element: 20 kHz.; 24 V initiator: 20 kHz.; NAMUR sensor: 20 kHz
• Cable length, max.	100 m
Status information/alarms/diagnostics	
Alarms	
• Diagnostic alarm	Yes; parameterizable
• Process alarm	Yes; parameterizable
Diagnoses	
• Diagnostic functions	Yes; Diagnostic information readable
Isolation	
Isolation, digital outputs	
• between the channels and the backplane bus	Yes; and shielding
Galvanic isolation, digital inputs	
• between the channels and the backplane bus	Yes; and shielding
• between the channels and the backplane bus (NAMUR)	Yes, against backplane bus and shielding
Isolation counter	
• between the channels and the backplane bus	Yes; and shielding
Dimensions and weight	
Width	80 mm
Height	125 mm
Depth	120 mm
Weights	
Weight, approx.	460 g

Ordering data

	Order No.
FM 350-2 counter module	6ES7 350-2AH00-0AE0
With 8 channels, max. 20 kHz; for 24 V incremental encoders and NAMUR encoders; incl. configuration package and electronic documentation on CD	
Front connector	
40-pin, with screw contacts	
• 1 unit	6ES7 392-1AM00-0AA0
• 100 units	6ES7 392-1AM00-1AB0
40-pin, with cage clamp terminals	
• 1 unit	6ES7 392-1BM01-0AA0
• 100 units	6ES7 392-1BM01-1AB0
Bus connectors	6ES7 390-0AA00-0AA0
1 piece (spare part)	
Labeling strips	6ES7 392-2XX00-0AA0
10 pieces (spare part)	
S7 SmartLabel	2XV9 450-1SL01-0YX0
Software for automatic labeling of modules based on data of the STEP 7 project	

	Order No.
Labeling sheets for machine inscription	See "Accessories", page 4/240
Slot number label	6ES7 912-0AA00-0AA0
Spare part	
Shield connection element	6ES7 390-5AA00-0AA0
80 mm wide, with 2 rows for 4 terminals each	
Terminal elements	
2 pieces	
For 2 cables with 2 mm to 6 mm diameter	6ES7 390-5AB00-0AA0
For 1 cable with 3 mm to 8 mm diameter	6ES7 390-5BA00-0AA0
For 1 cable with 4 mm to 13 mm diameter	6ES7 390-5CA00-0AA0
Signal cable	6FX5 002-2CA12-■■■■0
Preassembled for HTL and TTL encoder, without Sub-D connector, UL/DESINA	
Length code	see FM 350-1, page 4/149

SIMATIC S7-300

Function modules

SIPLUS FM 350-2 counter module

www.DataSheet4U.com

Overview



- 8-channel intelligent counter module for universal counter and measurement tasks
- For direct connection of 24 V incremental encoders, direction encoders, initiators or NAMUR sensors
- Compare function with programmable comparison values (number depends on operating mode)
- Integrated digital outputs to output the response upon reaching the comparison value
- Operating modes:
 - Continuous/one-shot/periodic counting
 - Frequency/speed control
 - Period measurement
 - Proportioning

Note:

SIMODRIVE Sensor/Motion Connect 500 feature incremental encoders and preassembled connecting cables for counting and positioning functions.

Additional information is available in the Internet under:

<http://www.siemens.com/simatic-technology>

	SIPLUS FM 350-2
Order No.	6AG1 350-2AH00-4AE0
Order No. based on	6ES7 350-2AH00-0AE0
Ambient temperature range	-25 ... +60 °C, condensation permissible
Ambient conditions	Suitable for extraordinary medial load (for example by chloric and sulphuric atmospheres).
Technical data	The technical data are identical with the technical data of the based on modules.

Ordering data	Order No.
SIPLUS FM 350-2 counter module	6AG1 350-2AH00-4AE0
(extended temperature range and medial load)	
With 8 channels, max. 20 kHz; for 24 V incremental encoders and NAMUR encoders; incl. configuration package and electronic documentation on CD	
Accessories	see S7-300 FM 350-2 counter module, page 4/151

SIMATIC S7-300

Function modules

FM 351 positioning module

www.DataSheet4U.com

Overview



- Two-channel positioning module for rapid-traverse/creep-speed drives
- 4 digital outputs per channel for motor control
- Incremental or synchro-serial position decoding

Note:

SIMODRIVE Sensor/Motion Connect 500 feature position-measuring systems and preassembled connecting cables for counting and positioning functions.

Additional information is available in the Internet under:

<http://www.siemens.com/simatic-technology>

4

Technical specifications

	6ES7 351-1AH01-0AE0
Supply voltages	
Rated value	
• DC 24 V	Yes
Current consumption	
Current consumption, max.	350 mA
Connection point	
required front connectors	1 x 20-pin
Digital inputs	
Number of digital inputs	8
Functions	Reference cams, reversing cams, flying actual value setting, start/stop positioning
Input voltage	
• Rated value, DC	24 V
• for signal "0"	-3 to 5 V
• for signal "1"	11 to 30 V
Input current	
• for 2-wire BERO	
- for signal "0", typ.	2 mA
- for signal "1", typ.	6 mA
Digital outputs	
Number of digital outputs	8
Functions	Rapid traverse, creep, run right, run left
Short-circuit protection of the output	Yes
Output voltage	
• Rated value (DC)	24 V
• for signal "1", min.	UP - 0.8 V
Output current	
• for signal "1" permissible range for 0 to 60 °C, min.	5 mA; with UPmax
• for signal "1" permissible range for 0 to 60 °C, max.	600 mA; with UPmax
• for signal "0" residual current, max.	0.5 mA
Encoder supply	
5 V encoder supply	
• 5 V	Yes

	6ES7 351-1AH01-0AE0
5 V encoder supply (cont.)	
• Output current, max.	350 mA
• Cable length, max.	32 m
24 V encoder supply	
• 24 V	Yes
• Output current, max.	400 mA; per channel
• Cable length, max.	100 m
Encoder	
Connectable encoders	
• Incremental encoder (symmetrical)	Yes
• Incremental encoder (asymmetrical)	Yes
• Absolute encoder (SSI)	Yes
• 2-wire BERO	Yes
• permissible quiescent current (2-wire BERO), max.	2 mA; on signal "0", max. 2 mA; on signal "1", max. 6 mA
Encoder signals, incremental encoder (symmetrical)	
• Trace mark signals	A, notA, B, notB
• Zero mark signal	N, notN
• Input signal	5 V difference signal (phys. RS 422)
• Input frequency, max.	0.5 MHz
Encoder signals, incremental encoder (asymmetrical)	
• Trace mark signals	A, B
• Zero mark signal	N
• Input voltage	24 V
• Input frequency, max.	50 kHz; 50 kHz for 25 m cable length, 25 kHz for 100 m cable length
Encoder signals, absolute encoder (SSI)	
• Input signal	5 V difference signal (phys. RS 422)
• Data signal	DATA, notDATA
• Clock signal	CL, notCL
• Telegram length	13 or 25 bit

www.DataSheet4U.com

SIMATIC S7-300

Function modules

FM 351 positioning module

Technical specifications (continued)

	6ES7 351-1AH01-0AE0
• Clock frequency, max.	1 MHz
• Gray code	Yes
• Cable length, shielded, max.	300 m; at max. 125 kHz
Isolation	
Isolation, digital outputs	
• Galvanic isolation, digital outputs	Yes

	6ES7 351-1AH01-0AE0
Galvanic isolation, digital inputs	
• galvanic isolation, digital inputs	Yes
Dimensions and weight	
Width	80 mm
Height	125 mm
Depth	120 mm
Weights	
Weight, approx.	550 g

Ordering data	Order No.
FM 351 positioning module for rapid traverse and creep speed drives	6ES7 351-1AH01-0AE0
Sub D connector 15-pin, male	6ES5 750-2AA21
Front connector 20-pin, with screw contacts	
• 1 unit	6ES7 392-1AJ00-0AA0
• 100 units	6ES7 392-1AJ00-1AB0
20-pin, with cage clamp terminals	
• 1 unit	6ES7 392-1BJ00-0AA0
• 100 units	6ES7 392-1BJ00-1AB0
Bus connectors	6ES7 390-0AA00-0AA0
1 unit (spare part)	
Labeling strips	6ES7 392-2XX00-0AA0
10 units (spare part)	
Slot number label	6ES7 912-0AA00-0AA0
S7 SmartLabel	2XV9 450-1SL01-0YX0
Software for automatic labeling of modules based on data of the STEP 7 project	
Labeling sheets for machine inscription	See "Accessories", page 4/240
Spare part	
Shield connection element	6ES7 390-5AA00-0AA0
80 mm wide, with 2 rows for 4 terminals each	
Terminal elements	
2 units	
For 2 cables with 2 mm to 6 mm diameter	6ES7 390-5AB00-0AA0
For 1 cable with 3 mm to 8 mm diameter	6ES7 390-5BA00-0AA0
For 1 cable with 4 mm to 13 mm diameter	6ES7 390-5CA00-0AA0

Signal cables

Signal cables	Order No.
Pre-assembled for HTL encoder, UL/DESINA	6 FX5 0 2-2 AL00- ■■■■
Pre-assembled for SSI absolute encoder, UL/DESINA	6 FX5 0 2-2 CC11- ■■■■
Pre-assembled for TTL encoder 6FX2001-1, UL/DESINA	6 FX5 0 2-2 CD11- ■■■■
Pre-assembled for TTL encoder 24 V, UL/DESINA	6 FX5 0 2-2 CD24- ■■■■
Not crimped	0
Module end crimped, connector case supplied	1
Motor end crimped, connector case supplied	4
0 m	1
100 m	2
200 m	3
0 m	A
10 m	B
20 m	C
30 m	D
40 m	E
50 m	F
60 m	G
70 m	H
80 m	J
90 m	K
0 m	A
1 m	B
2 m	C
3 m	D
4 m	E
5 m	F
6 m	G
7 m	H
8 m	J
9 m	K
0.0 m	0
0.1 m	1
0.2 m	2
0.3 m	3
0.4 m	4
0.5 m	5
0.6 m	6
0.7 m	7
0.8 m	8

SIMATIC S7-300

Function modules

FM 352 cam controller

4

www.DataSheet4U.com

Overview



- Extremely high-speed electronic cam controller
- Low-cost alternative to mechanical cam controllers
- 32 cam tracks, 13 onboard digital outputs for direct output of actions
- Incremental or synchro-serial position decoding

Note:

SIMODRIVE Sensor/Motion Connect 500 feature position-measuring systems and preassembled connecting cables for counting and positioning functions.

Additional information is available in the Internet under:

<http://www.siemens.com/simatic-technology>

Technical specifications

	6ES7 352-1AH01-0AE0
Supply voltages	
Rated value	
• DC 24 V	Yes
Current consumption	
from load voltage L+ (without load), max.	200 mA
from backplane bus DC 5 V, max.	100 mA
Connection point	
required front connectors	1 x 20-pin
Digital inputs	
Number of digital inputs	4
Functions	Reference point switch, flying actual value setting/length measurement, brake release, enable track output No. 3
Input voltage	
• Rated value, DC	24 V
• for signal "0"	-3 to 5 V
• for signal "1"	11 to 30 V
Input current	
• for 2-wire BERO	
- for signal "0", typ.	2 mA
- for signal "1", typ.	9 mA
Digital outputs	
Number of digital outputs	13
Functions	Cam track
Short-circuit protection of the output	Yes
Output voltage	
• Rated value (DC)	24 V
• for signal "1", min.	UP - 0,8 V

	6ES7 352-1AH01-0AE0
Output current	
• for signal "1" permissible range for 0 to 60 °C, min.	5 mA; with UPmax
• for signal "1" permissible range for 0 to 60 °C, max.	600 mA; with UPmax
• for signal "0" residual current, max.	0.5 mA
Encoder supply	
5 V encoder supply	
• 5 V	Yes
• Output current, max.	300 mA
• Cable length, max.	32 m
24 V encoder supply	
• 24 V	Yes
• Output current, max.	300 mA
• Cable length, max.	100 m
Encoder	
Connectable encoders	
• Incremental encoder (symmetrical)	Yes
• Incremental encoder (asymmetrical)	Yes
• Absolute encoder (SSI)	Yes
• 2-wire BEROS	Yes
• permissible quiescent current (2-wire BEROS), max.	2 mA; on signal "0", max. 2 mA; on signal "1", max. 9 mA
Encoder signals, incremental encoder (symmetrical)	
• Trace mark signals	A, notA, B, notB
• Zero mark signal	N, notN
• Input signal	5 V difference signal (phys. RS 422)
• Input frequency, max.	1 MHz

SIMATIC S7-300

Function modules

FM 352 cam controller

Technical specifications (continued)

	6ES7 352-1AH01-0AE0
Encoder signals, incremental encoder (asymmetrical)	
• Trace mark signals	A, B
• Zero mark signal	N
• Input voltage	24 V
• Input frequency, max.	50 kHz; 50 kHz for 25 m cable length, 25 kHz for 100 m cable length
Encoder signals, absolute encoder (SSI)	
• Data signal	DATA, notDATA
• Clock signal	CL, notCL
• Telegram length	13 or 25 bit
• Clock frequency, max.	1 MHz
• Gray code	Yes
• Cable length, shielded, max.	320 m; at max. 125 kHz

	6ES7 352-1AH01-0AE0
Isolation	
Isolation, digital outputs	
• Galvanic isolation, digital outputs	No
Galvanic isolation, digital inputs	
• galvanic isolation, digital inputs	No
Dimensions and weight	
Width	80 mm
Height	125 mm
Depth	120 mm
Weights	
Weight, approx.	550 g

Ordering data

	Order No.
FM 352 electronic cam controller	6ES7 352-1AH01-0AE0
Sub-D connector	6ES5 750-2AA21
15-pin, male	
Front connector	
20-pin, with screw contacts	
• 1 unit	6ES7 392-1AJ00-0AA0
• 100 units	6ES7 392-1AJ00-1AB0
20-pin, with cage clamp terminals	
• 1 unit	6ES7 392-1BJ00-0AA0
• 100 units	6ES7 392-1BJ00-1AB0
Bus connectors	6ES7 390-0AA00-0AA0
1 piece (spare part)	
Labeling strips	6ES7 392-2XX00-0AA0
10 pieces (spare part)	
S7 SmartLabel	2XV9 450-1SL01-0YX0
Software for automatic labeling of modules based on data of the STEP 7 project	
Labeling sheets for machine inscription	See "Accessories", page 4/240
Slot number label	6ES7 912-0AA00-0AA0
Spare part	

	Order No.
Shield connection element	6ES7 390-5AA00-0AA0
80 mm wide, with 2 rows for 4 terminals each	
Terminal elements	
2 pieces	
For 2 cables with 2 mm to 6 mm diameter	6ES7 390-5AB00-0AA0
For 1 cable with 3 mm to 8 mm diameter	6ES7 390-5BA00-0AA0
For 1 cable with 4 mm to 13 mm diameter	6ES7 390-5CA00-0AA0
Signal cable	
Pre-assembled for HTL encoder, UL/DESINA	6FX5 0 2-2AL00-■■■■
Pre-assembled for SSI absolute encoder, UL/DESINA	6FX5 0 2-2CC11-■■■■
Pre-assembled for TTL encoder 6FX2001-1, UL/DESINA	6FX5 0 2-2CD01-■■■■
Pre-assembled for TTL encoder 24 V, UL/DESINA	6FX5 0 2-2CD24-■■■■
Length code	see FM 351, page 4/154

SIMATIC S7-300

Function modules

FM 352-5 high speed Boolean processor

www.DataSheet4U.com

Overview



- The FM 352-5 High-speed Boolean processor offers an extremely fast binary control and some of the quickest switching procedures ever possible (cycle duration: 1 μ s)
- Programming with LAD or FBD is possible
- The instruction set available includes bit instructions (instruction subset of STEP 7), timers, counters, frequency dividers, frequency generators, and shift registers.
- 12 integrated DI/8 integrated DO
- 2 versions: Current sinking or current sourcing digital outputs
- 1 channel for connecting a 24 V incremental encoder, a 5 V incremental encoder (RS422) or a serial interface absolute encoder

A micro memory card is required for operation of the FM 352-5

Note:

SIMODRIVE Sensor/Motion Connect 500 feature position-measuring systems and preassembled connecting cables for counting and positioning functions.

Additional information is available in the Internet under:

<http://www.siemens.com/simatic-technology>

Technical specifications

	6ES7 352-5AH00-0AE0	6ES7 352-5AH10-0AE0
Supply voltages		
Rated value		
• DC 24 V	Yes	Yes
Voltages and currents		
Load voltage L+		
• Rated value (DC)	24 V	24 V
• reverse polarity protection	Yes	Yes
• permissible range, lower limit (DC)	20.4 V	20.4 V
• permissible range, upper limit (DC)	28.8 V	28.8 V
Current consumption		
from load voltage 1L+, max.	150 mA; typ. 60 mA	150 mA; typ. 60 mA
from load voltage 2L+ (without load), max.	200 mA; typ. 60 mA, DI/DO supply	200 mA; typ. 60 mA, DI/DO supply
from load voltage 3L+ (with encoder), max.	600 mA; typ. 80 mA plus encoder supply	600 mA; typ. 80 mA plus encoder supply
from load voltage 3L+ (without encoder), max.	200 mA; typ. 80 mA	200 mA; typ. 80 mA
from backplane bus DC 5 V, max.	100 mA; typically	1100 mA; typically
Power loss, typ.	6.5 W	6.5 W
Memory		
Memory		
• Memory Card, RAM	128 KByte; required for operation, MMC	128 KByte; required for operation, MMC
Interfaces		
Updating time	PLC interface: 5ms (2.6 ms typ)	PLC interface: 5ms (2.6 ms typ)

	6ES7 352-5AH00-0AE0	6ES7 352-5AH10-0AE0
Connection point		
required front connectors	1 x 40-pin	1 x 40-pin
CPU/programming		
Program cycle time (scan)	1 μ s	1 μ s
Digital inputs		
Number of digital inputs	8; standard and up to 12 at 24 V DC encoder inputs as digital inputs	8; standard and up to 12 at 24 V DC encoder inputs as digital inputs
Cable length		
• Cable length, shielded, max.	600 m; shielded cable recommended if filtering set in 1.6 ms frame.	600 m; shielded cable recommended if filtering set in 1.6 ms frame.
• Cable length unshielded, max.	100 m	100 m
Input voltage		
• Rated value, DC	24 V	24 V
• for signal "0"	-30 V to 5 V	-30 V to 5 V
• for signal "1"	11 to 30 V	11 to 30 V
Input current		
• for signal "0", max. (permissible quiescent current)	1.5 mA	1.5 mA
• for signal "1", typ.	3.8 mA	3.8 mA

www.DataSheet4U.com

SIMATIC S7-300

Function modules

FM 352-5 high speed Boolean processor

Technical specifications (continued)

	6ES7 352-5AH00-0AEO	6ES7 352-5AH10-0AEO
Input delay (for rated value of input voltage)		
• Input frequency (with 0.1 ms delay), max.	200 kHz	200 kHz
• Programmable digital filter delay	None, 5µs, 10µs, 15µs, 20µs, 50µs, 1.5ms	None, 5µs, 10µs, 15µs, 20µs, 50µs, 1.5ms
• Minimum pulse width for program reactions	1µs, 5µs, 10µs, 15µs, 20µs, 50µs, 1.6ms	1µs, 5µs, 10µs, 15µs, 20µs, 50µs, 1.6ms
• for standard inputs - at "0" to "1", max.	3 µs; typ. 1.5 µs	3 µs; typ. 1.5 µs
Digital outputs		
Number of digital outputs	8	8
M-switching	Yes	
P-switching		Yes
Cable length, shielded, max.	600 m	600 m
Cable length unshielded, max.	100 m	100 m
Short-circuit protection of the output	Yes; Overvoltage protection, thermal protection	Yes; Overvoltage protection, thermal protection
• Response threshold, typ.	1.7 A to 3.5 A	1.7 A to 3.5 A
Limitation of inductive shutdown voltage to	2M +45 V typ, (40 to 55 V) Note: no protection against inductive kickback >55mJ	2M +45 V typ, (40 to 55 V) Note: no protection against inductive kickback >55mJ
Lamp load, max.	5 W	5 W
Controlling a digital input	No	No
Output voltage		
• Rated value (DC)	24 V	24 V
• for signal "0" (DC), max.	28.8 V	28.8 V
• for signal "1" (DC), max.	0.5 V	0.5 V
Output current		
• for signal "1" rated value	0.5 A; at 60 °C	0.5 A; at 60 °C
• for signal "1" permissible range for 0 to 60 °C, min.	5 mA	5 mA
• for signal "1" permissible range for 0 to 60 °C, max.	600 mA	600 mA
• for signal "0" residual current, max.	1 mA	1 mA
Output delay with resistive load		
• "0" to "1", max.	1 µs; 0.6 µs 50 mA / 1.0 µs 0.5 Amp	1 µs; 0.6 µs 50 mA / 1.0 µs 0.5 Amp
• "1" to "0", max.	1.5 µs; 1.7µs 50 mA / 1.5µs 0.5 Amp	1.5 µs; 1.7µs 50 mA / 1.5µs 0.5 Amp
Parallel switching of 2 outputs		
• for increased power	Yes; 2	Yes; 2

	6ES7 352-5AH00-0AEO	6ES7 352-5AH10-0AEO
Switching frequency		
• with resistive load, max.	100 kHz; 20 kHz at 0.5 A; 100 kHz at 0.25 A	100 kHz; 20 kHz at 0.5 A; 100 kHz at 0.25 A
• with inductive load, max.	2 Hz; 2 Hz at 0.5 A with external commutator diodes; 0.5 Hz at 0.5 A without external commutator diodes	2 Hz; 2 Hz at 0.5 A with external commutator diodes; 0.5 Hz at 0.5 A without external commutator diodes
• on lamp load, max.	10 Hz	10 Hz
Encoder supply		
5 V encoder supply		
• 5 V	Yes	Yes
• Short-circuit protection	Yes; Electronic overload. No protection on applying a normal or counter voltage.	Yes; Electronic overload. No protection on applying a normal or counter voltage.
• Output current, max.	250 mA	250 mA
24 V encoder supply		
• 24 V	Yes	Yes
• Short-circuit protection	Yes; Overvoltage and overheating protection if overloaded. Diagnostics if output reaches temperature limit. No protection when setting up a normal or counter voltage	Yes; Overvoltage and overheating protection if overloaded. Diagnostics if output reaches temperature limit. No protection when setting up a normal or counter voltage
• Output current, max.	400 mA	400 mA
Encoder		
Connectable encoders		
• Incremental encoder (symmetrical)	Yes	Yes
• Incremental encoder (asymmetrical)	Yes	Yes
• Absolute encoder (SSI)	Yes	Yes
• 2-wire BEROS	Yes; typ. 1 A	Yes; typ. 1 A
• permissible quiescent current (2-wire BEROS), max.	1.5 mA	1.5 mA
Encoder signals, incremental encoder (symmetrical)		
• Trace mark signals	A, notA, B, notB	A, notA, B, notB
• Zero mark signal	N, notN	N, notN
• Input signal	5 V difference signal (phys. RS 422)	5 V difference signal (phys. RS 422)
• Input frequency, max.	1 MHz	1 MHz

SIMATIC S7-300

Function modules

FM 352-5 high speed Boolean processor

4

Technical specifications (continued)

	6ES7 352-5AH00-0AEO	6ES7 352-5AH10-0AEO
Encoder signals, incremental encoder (symmetrical) (continued)		
• Cable length, shielded, max.	100 m; Cable length, RS-422 (5V) incremental encoder, Siemens type 6FX201-2, 5V supply: 500kHz, 32 m, shielded, max.; Cable length, RS 422 (5V) incremental encoder, Siemens type 6FX201-2, 24V supply: 500 kHz, 100 m, shielded, max.	100 m; Cable length, RS-422 (5V) incremental encoder, Siemens type 6FX201-2, 5V supply: 500kHz, 32 m, shielded, max.; Cable length, RS 422 (5V) incremental encoder, Siemens type 6FX201-2, 24V supply: 500 kHz, 100 m, shielded, max.
Encoder signals, incremental encoder (asymmetrical)		
• Trace mark signals	A, B	A, B
• Zero mark signal	N	N
• Input voltage	24 V	24 V
• Input frequency, max.	200 kHz	200 kHz
• cable length, shielded, max.	50 m; Cable length, HTL incremental encoder, Siemens, type 6FX2001-4: 50kHz, 25 m shielded, max., 25kHz, 50 m shielded, max.	50 m; Cable length, HTL incremental encoder, Siemens, type 6FX2001-4: 50kHz, 25 m shielded, max., 25kHz, 50 m shielded, max.
Encoder signals, absolute encoder (SSI)		
• Data signal	DATA, notDATA	DATA, notDATA
• Clock signal	CK, notCK	CK, notCK
• Telegram length	13 or 25 bit	13 or 25 bit
• Clock frequency, max.	1 MHz; 125 kHz, 250 kHz, 500 kHz, or 1 MHz	1 MHz; 125 kHz, 250 kHz, 500 kHz, or 1 MHz
• Cable length, shielded, max.	320 m; Cable length, RS-422 SSI absolute encoder, Siemens Type 6FX201-5, 24V supply: 125 kHz, 320 m, shielded, max.; 250kHz, 160 meter shielded, max., 500kHz, 60 m shielded, max., 1MHz, 20 m shielded, max.	320 m; Cable length, RS-422 SSI absolute encoder, Siemens Type 6FX201-5, 24V supply: 125 kHz, 320 m, shielded, max.; 250kHz, 160 meter shielded, max., 500kHz, 60 m shielded, max., 1MHz, 20 m shielded, max.
• Monoflop time	adjustable: 16/32/48/64 μs	adjustable: 16/32/48/64 μs
• Listening mode	Yes; one or two stations	Yes; one or two stations
• Multiturn	Yes; 25 bit message frame	Yes; 25 bit message frame

	6ES7 352-5AH00-0AEO	6ES7 352-5AH10-0AEO
Encoder signal evaluation		
• Counting direction, forward	Yes	Yes
• Counting direction, backward	Yes	Yes
Reaction times		
Input and output reaction time	5V input to 24V output, 0-filter: 1 to 4μs (typ.); 24V input to 24V output, 0-filter: 2 to 6μs (typ.)	5V input to 24V output, 0-filter: 1 to 4μs (typ.); 24V input to 24V output, 0-filter: 2 to 6μs (typ.)
Counters		
Counting range, Description	Counter range (16-bit counter): -32768 to 32767 (user-specific within this range); counter range (32-bit counter): -2,147,483,648 to 2,147,483,647 (user-specific within this range)	Counter range (16-bit counter): -32768 to 32767 (user-specific within this range); counter range (32-bit counter): -2,147,483,648 to 2,147,483,647 (user-specific within this range)
Counting range, lower limit	-2147483648	-2147483648
Counting range, upper limit	2,147,483,647	2,147,483,647
Counting mode		
• Counting mode, individual	Yes	Yes
• Counting mode, continuous	Yes	Yes
• Counting mode, periodic	Yes	Yes
Status information/alarms/diagnostics		
Alarms		
• Diagnostic alarm	Yes; 1L, 2L, 3L missing; MMC error; output overload (8); encoder supply overload; differential wire break; parameterization error; SSI message frame overflow	Yes; 1L, 2L, 3L missing; MMC error; output overload (8); encoder supply overload; differential wire break; parameterization error; SSI message frame overflow
• Process alarm	Yes; 8 available; for generation by user program	Yes; 8 available; for generation by user program
Diagnoses		
• Wire break in signal encoder cable	Yes	Yes
• Overflow/underflow	Yes	Yes
• missing load voltage	Yes	Yes

SIMATIC S7-300

Function modules

FM 352-5 high speed Boolean processor

Technical specifications (continued)

	6ES7 352-5AH00-0AE0	6ES7 352-5AH10-0AE0
Isolation		
between 1L and 2L and 3L	Yes; 75 V DC / 60 V AC	Yes; 75 V DC / 60 V AC
between digital I/O & 2L and encoder I/O & 3L	Yes (75 V DC, 60 V AC)	Yes (75 V DC, 60 V AC)
between backplane bus and digital & encoder I/O & 1L & 2L & 3L	Yes (75 V DC, 60 V AC)	Yes (75 V DC, 60 V AC)
Galvanic isolation, digital inputs		
• galvanic isolation, digital inputs	Yes	Yes

	6ES7 352-5AH00-0AE0	6ES7 352-5AH10-0AE0
Dimensions and weight		
Width	80 mm	80 mm
Height	125 mm	125 mm
Depth	120 mm	120 mm
Weights		
Weight, approx.	434 g	434 g

Ordering data

	Order No.
FM 352-5 high-speed Boolean processor	
with current sinking digital outputs	A) 6ES7 352-5AH00-0AE0
with current sourcing digital outputs	A) 6ES7 352-5AH10-0AE0
Configuring software for FM 352-5	E) 6ES7 352-5AH00-7XG0
5 languages En., Ge., Fr., Sp., It.; executes under Windows 98/Me/NT 4.0 SP 3 and higher / 2000 Professional SP 1 and higher	
Micro Memory Card	
128 KB	6ES7 953-8LG11-0AA0
512 KB	6ES7 953-8LJ11-0AA0
2 MB	6ES7 953-8LL11-0AA0

A) Subject to export regulations: AL: N and ECCN: EAR99H

E) Subject to export regulations: AL: N and ECCN: EAR99S

Order No.

Front connector	
40-pin, with screw contacts	
• 1 unit	6ES7 392-1AM00-0AA0
• 100 units	6ES7 392-1AM00-1AB0
40-pin, with cage clamp terminals	
• 1 unit	6ES7 392-1BM01-0AA0
• 100 units	6ES7 392-1BM01-1AB0
Signal cables	
To HTL and TTL encoders, preassembled, without Sub-D connector	6FX5 002-2CA12- ■■■■0
To SSI absolute encoders 6FX2 001-5, preassembled, without Sub-D connector	6FX5 002-2CC12- ■■■■
Length code:	see FM 351, page 4/154

SIMATIC S7-300

Function modules

FM 353 positioning module

www.DataSheet4U.com

Overview



- Positioning module for stepper motors in machines with high clock pulse rates
- Can be used for point-to-point positioning tasks and for complex traversing patterns

4

Technical specifications

	6ES7 353-1AH01-0AE0
Supply voltages	
Rated value	
• DC 24 V	Yes
• permissible range, lower limit (DC)	20.4 V
• permissible range, upper limit (DC)	28.8 V
Current consumption	
Current consumption, max.	300 mA
Connection point	
required front connectors	1 x 20-pin
Digital inputs	
Number of digital inputs	4; (+ 1 input for message signal)
Functions	Reference cams, flying actual value setting, flying measurement, start/stop positioning, external block change
Input voltage	
• Rated value, DC	24 V
• for signal "0"	-3 to 5 V
• for signal "1"	11 to 30 V
Input current	
• for signal "0", max. (permissible quiescent current)	2 mA
• for signal "1", typ.	6 mA; 6 to 15 mA
Digital outputs	
Number of digital outputs	4
Functions	Position reached: stop, axis travels forward, axis travels back, change M-function M97, change M-function M98, start enable, direct output via data record
Short-circuit protection of the output	Yes

	6ES7 353-1AH01-0AE0
Output voltage	
• Rated value (DC)	24 V
• for signal "1", min.	UP - 3 V
Output current	
• for signal "1" permissible range for 0 to 55 °C, max.	0.6 A; with UPmax
• for signal "0" residual current, max.	2 mA
Drive interface	
Signal input I	
• Function	"Power section ready"
Signal output I	
• Type	5 V difference signal (phys. RS 422)
• Function	Direction, enable, clock pulse, current control
• Differential output voltage, min.	2 V; RL = 100 Ohm
• Differential output voltage for signal "0", max.	1 V; I _o = 20 mA
• Differential output voltage, for signal "1", min.	3.7 V; I _o = -20 mA
• Cable length, max.	35 m
Isolation	
Isolation, digital outputs	
• Galvanic isolation, digital outputs	No
Galvanic isolation, digital inputs	
• galvanic isolation, digital inputs	No
Dimensions and weight	
Width	80 mm
Height	125 mm
Depth	118 mm
Weights	
Weight, approx.	500 g

SIMATIC S7-300

Function modules

FM 353 positioning module

4

www.DataSheet4U.com

Ordering data	Order No.	Order No.
FM 353 positioning module For stepper motors; incl. configuration package on CD-ROM (Ge, En, Fr, It) comprising <ul style="list-style-type: none"> • FM 353 manual, electronic • Standard function blocks (STEP 7 interface software) • Screen form-based configuration software for FM 353 • Standard interactive screen forms for OP7/OP17 	6ES7 353-1AH01-0AE0	Front connector 20-pin, with screw contacts <ul style="list-style-type: none"> • 1 unit 6ES7 392-1AJ00-0AA0 • 100 units 6ES7 392-1AJ00-1AB0 20-pin, with cage clamp terminals <ul style="list-style-type: none"> • 1 unit 6ES7 392-1BJ00-0AA0 • 100 units 6ES7 392-1BJ00-1AB0
FM 353 manual German English French Italian	6ES7 353-1AH01-8AG0 6ES7 353-1AH01-8BG0 6ES7 353-1AH01-8CG0 6ES7 353-1AH01-8EG0	Bus connectors 6ES7 390-0AA00-0AA0 1 unit (spare part)
Edit FM Program editor for editing, loading and saving NC programs with the standard programming device/PC; German/English, on CD-ROM	6FC5 263-0AA03-0AB0	Labeling strips 6ES7 392-2XX00-0AA0 10 units (spare part)
Connecting cables To stepper motor power section Length code	6FX8 0.2-3AC02-.... see FM 351, page 4/154	S7 SmartLabel 2XV9 450-1SL01-0YX0 Software for automatic labeling of modules based on data of the STEP 7 project
Connecting cables and encoders	see catalog NC 60, CA 01 or in the A&D Mall	Labeling sheets for machine inscription see "Accessories", page 4/240
Sub D connector 15-pin, socket	6ES5 750-2AB21	Slot number label 6ES7 912-0AA00-0AA0 Spare part
		Shield connection element 6ES7 390-5AA00-0AA0 80 mm wide, with 2 rows for 4 terminals each
		Terminal elements 2 units For 2 cables with 2 mm to 6 mm diameter 6ES7 390-5AB00-0AA0 For 1 cable with 3 mm to 8 mm diameter 6ES7 390-5BA00-0AA0 For 1 cable with 4 mm to 13 mm diameter 6ES7 390-5CA00-0AA0

SIMATIC S7-300

Function modules

FM 354 positioning module

www.DataSheet4U.com

Overview



- Positioning module for servo motors in machines with high clock pulse rates
- Can be used for point-to-point positioning tasks and for complex traversing patterns

Note:

SIMODRIVE Sensor/Motion Connect 500 feature position-measuring systems and preassembled connecting cables for counting and positioning functions.

Additional information is available in the Internet under:

<http://www.siemens.com/simatic-technology>

4

Technical specifications

	6ES7 354-1AH01-0AE0
Supply voltages	
Rated value	
• DC 24 V	Yes
Current consumption	
Current consumption, max.	350 mA
Connection point	
required front connectors	1 x 20-pin
Digital inputs	
Number of digital inputs	4
Functions	Reference cams, flying actual value setting, flying measurement, start/stop positioning, external block change
Input voltage	
• Rated value, DC	24 V
• for signal "0"	-3 to 5 V
• for signal "1"	11 to 30 V
Input current	
• for signal "0", max. (permissible quiescent current)	2 mA
• for signal "1", typ.	6 mA; 6 to 15 mA
Digital outputs	
Number of digital outputs	4
Functions	Position reached: stop, axis travels forward, axis travels back, change M-function M97, change M-function M98, start enable, direct output via data record
Short-circuit protection of the output	Yes

	6ES7 354-1AH01-0AE0
Output voltage	
• Rated value (DC)	24 V
• for signal "1", min.	UP - 3 V
Output current	
• for signal "1" permissible range for 0 to 55 °C, max.	0.6 A; with UPmax
• for signal "0" residual current, max.	2 mA
Encoder supply	
5 V encoder supply	
• 5 V	Yes
• Output current, max.	220 mA
• Cable length, max.	35 m
24 V encoder supply	
• 24 V	Yes
• Output current, max.	300 mA
• Cable length, max.	100 m
Encoder	
Connectable encoders	
• Incremental encoder (symmetrical)	Yes
• Absolute encoder (SSI)	Yes
Encoder signals, incremental encoder (symmetrical)	
• Trace mark signals	A, notA, B, notB
• Zero mark signal	N, notN
• Input signal	5 V difference signal (phys. RS 422)
• Input frequency, max.	1 MHz

SIMATIC S7-300

Function modules

FM 354 positioning module

Technical specifications (continued)

	6ES7 354-1AH01-0AE0
Encoder signals, absolute encoder (SSI)	
• Input signal	5 V difference signal (phys. RS 422)
• Data signal	DATA, notDATA
• Clock signal	CL, notCL
• Telegram length	13, 21 or 25 bit
• Cable length, shielded, max.	100 m; 10 m at 1.25 Mbit/s, 100 m at max. 125 kbit/s
Drive interface	
Signal input I	
• Type	Input loop controller message, isolated (optocoupler)
• Function	"Drive ready"
• Input voltage, rated value (DC)	24 V
• Input voltage, for signal "0"	-3 to 5 V
• Input voltage, for signal "1"	15 to 30 V
• Input current, for signal "1"	2 mA to 6 mA
Signal output II	
• Type	Output closed-loop controller enable (contact)
• Function	Drive disconnection for operation via contact relay
• Load	1 A/50 V/30 VA DC

	6ES7 354-1AH01-0AE0
Signal output III	
• Type	Analog output
• Function	Setpoint output for drive
• Output voltage	-10 to +10 V
• Output current	-3 to +3 mA
• Cable length, max.	35 m
Isolation	
Isolation, digital outputs	
• Galvanic isolation, digital outputs	No
Galvanic isolation, digital inputs	
• galvanic isolation, digital inputs	No
Dimensions and weight	
Width	80 mm
Height	125 mm
Depth	118 mm
Weights	
Weight, approx.	550 g

SIMATIC S7-300

Function modules

FM 354 positioning module

4

Ordering data	Order No.	Order No.
FM 354 positioning module B) for servo motors, incl. configuration package on CD-ROM (Ge, En, Fr, It) comprising <ul style="list-style-type: none"> • FM 354 manual, electronic • Standard function blocks (STEP 7 interface software) • Screen form-based configuration software for FM 354 • Standard interactive screen forms for OP7/OP17 	6ES7 354-1AH01-0AE0	To SIMODRIVE 611A, preassembled, suitable for trailing 6FX8 0 2-2CJ00-■■■■■ To SIMODRIVE 611U, preassembled, suitable for trailing, 1 free end 6FX8 0 2-2CJ10-■■■■■ To SIMODRIVE 611A, preassembled, suitable for trailing, free ends 6FX8 0 2-3AB01-■■■■■ Length code see FM 351, page 4/154 Encoders see catalogs NC 60, CA 01 or in the A&D Mall
FM 354 manual German 6ES7 354-1AH01-8AG0 English 6ES7 354-1AH01-8BG0 French 6ES7 354-1AH01-8CG0 Italian 6ES7 354-1AH01-8EG0		Sub D connector 15-pin, male 6ES5 750-2AA21 9-pin, female 6ES5 750-2AB11
Edit FM Program editor for editing, loading and saving NC programs with the standard programming device/PC; German/English, on CD-ROM 6FC5 263-0AA03-0AB0		Front connector 20-pin, with screw contacts <ul style="list-style-type: none"> • 1 unit 6ES7 392-1AJ00-0AA0 • 100 units 6ES7 392-1AJ00-1AB0 20-pin, with cage clamp terminals <ul style="list-style-type: none"> • 1 unit 6ES7 392-1BJ00-0AA0 • 100 units 6ES7 392-1BJ00-1AB0
Connecting cables To SSI absolute encoders 6FX2 001-5, preassembled 6FX5 0 2-2CC11-■■■■■ To incremental encoders 6FX2 001-1, preassembled 6FX5 0 2-2CD01-■■■■■ For 24 V incremental encoders, preassembled 6FX5 0 2-2CD24-■■■■■ To ROD 320 built-in encoders, preassembled 6FX5 0 2-2CE02-■■■■■ To SIMODRIVE 611A, preassembled 6FX5 0 2-2CJ00-■■■■■ To SIMODRIVE 611U, preassembled 6FX5 0 2-2CJ10-■■■■■ To SSI absolute encoders 6FX2 001-5, preassembled, without Sub-D connector 6FX5 002-2CC12-■■■■■ To SSI absolute encoders 6FX2 001-5, preassembled, suitable for trailing 6FX8 0 2-2CC11-■■■■■ To incremental encoders 6FX2 001-2, preassembled, suitable for trailing 6FX8 0 2-2CD01-■■■■■ To ROD 320 built-in encoders, preassembled, suitable for trailing 6FX8 0 2-2CE02-■■■■■ Length code see FM 351, page 4/154		Bus connectors 6ES7 390-0AA00-0AA0 1 unit (spare part) Labeling strips 6ES7 392-2XX00-0AA0 10 units (spare part) S7 SmartLabel 2XV9 450-1SL01-0YX0 Software for automatic labeling of modules based on data of the STEP 7 project Labeling sheets for machine inscription see "Accessories", page 4/240 Slot number label 6ES7 912-0AA00-0AA0 Spare part Shield connection element 6ES7 390-5AA00-0AA0 80 mm wide, with 2 rows for 4 terminals each Terminal elements 2 units For 2 cables with 2 mm to 6 mm diameter 6ES7 390-5AB00-0AA0 For 1 cable with 3 mm to 8 mm diameter 6ES7 390-5BA00-0AA0 For 1 cable with 4 mm to 13 mm diameter 6ES7 390-5CA00-0AA0

B) Subject to export regulations: AL: N and ECCN: 4A994

SIMATIC S7-300

Function modules

FM 357-2 positioning module

www.DataSheet4U.com

Overview



- Path and positioning control for intelligent motion control of up to 4 axes
- Covers a wide spectrum from independent individual positioning axes through to interpolatory multi-axis continuous-path control
- For the control of stepper motors and controlled servo-drive axes
- User-friendly startup through easy-to-use parameterization tool
- Interface for SIMODRIVE 611U and MASTERDRIVES MC via the isochronous PROFIBUS (not for FM 357-2H in combination with HT6)

Note:

SIMODRIVE Sensor/Motion Connect 500 feature position-measuring systems and preassembled connecting cables for counting and positioning functions.

Additional information is available in the Internet under:

<http://www.siemens.com/simatic-technology>

Technical specifications

	6ES7 357-4AH01-0AE0
Supply voltages	
Rated value	
• DC 24 V	Yes
Voltages and currents	
Power consumption	
• Power consumption, typ.	24 W
Current consumption	
from backplane bus DC 5 V, max.	100 mA
Memory	
Memory	
• NC program memory	750 KByte
Connection point	
required front connectors	1 x 40-pin
Digital inputs	
Number of digital inputs	18
Functions	4 Bero, 2 probes, 12 for any use
Input voltage	
• Rated value, DC	24 V
• for signal "0"	-3 to 5 V
• for signal "1"	11 to 30 V
Input current	
• for signal "0", max. (permissible quiescent current)	2 mA
• for signal "1", typ.	6 mA; 6 to 30 mA
Digital outputs	
Number of digital outputs	8
Functions	8 for any use
Output voltage	
• Rated value (DC)	24 V
• for signal "1", min.	UP - 3 V
• for signal "1" permissible range for 0 to 55 °C, max.	0.5 A; with UPmax

	6ES7 357-4AH01-0AE0
Output current	
• for signal "0" residual current, max.	2 mA
Encoder supply	
5 V encoder supply	
• 5 V	Yes
• Output current, max.	210 mA
• Cable length, max.	35 m
24 V encoder supply	
• 24 V	Yes
• Output current, max.	300 mA
• Cable length, max.	100 m
Encoder	
Connectable encoders	
• Incremental encoder (symmetrical)	Yes
• Absolute encoder (SSI)	Yes
Encoder signals, incremental encoder (symmetrical)	
• Trace mark signals	A, notA, B, notB
• Zero mark signal	N, notN
• Input signal	5 V difference signal (phys. RS 422)
• Input frequency, max.	1 MHz
Encoder signals, absolute encoder (SSI)	
• Input signal	5 V difference signal (phys. RS 422)
• Data signal	DATA, notDATA
• Clock signal	CL, notCL
• Telegram length	13, 21 or 25 bit
• cable length, shielded, max.	250 m; at max. 187.5 kBit/s

www.DataSheet4U.com

SIMATIC S7-300

Function modules

FM 357-2 positioning module

4

Technical specifications (continued)

	6ES7 357-4AH01-0AE0
Positioning	
Programmable traverse speed, max.	1,000 m/min
Drive interface	
Signal output I	
• Type	5 V difference signal (phys. RS 422)
• Function	Direction, enable, clock pulse
• Differential output voltage, min.	2 V; RL = 100 Ohm
• Differential output voltage for signal "0", max.	1 V; I _o = 20 mA
• Differential output voltage, for signal "1", min.	3.7 V; I _o = -20 mA
• Pulse frequency	750 kHz
• Cable length, max.	50 m; 35 m in hybrid mode with servo axes
Signal output II	
• Type	Controller release (contact), FM-READY output (contact)
• Function	Drive disconnection for operation via contact relay, Data set ready for link with Emergency STOP
• Load	1 A/50 V/30 VA DC

	6ES7 357-4AH01-0AE0
Signal output III	
• Type	Analog output
• Function	Drive interface for analog drives: setpoint output for drive
• Output voltage	-10 to +10 V
• Output current	-3 to +3 mA
• Cable length, max.	35 m
Isolation	
Isolation, digital outputs	
• Galvanic isolation, digital outputs	Yes
Galvanic isolation, digital inputs	
• galvanic isolation, digital inputs	Yes
Dimensions and weight	
Width	200 mm
Height	125 mm
Depth	118 mm
Weights	
Weight, approx.	1,200 g

Ordering data

	Order No.
FM 357-2 positioning module B)	6ES7 357-4AH01-0AE0
Basic unit	
System firmware	
incl. configuration package on CD-ROM, German, English, French, Italian, consisting of equipment manual (electronic), configuring software (parameterization screenforms, standard blocks, operator control and monitoring screenforms for OP17/OP27)	
FM 357-2L system firmware	6ES7 357-4AH03-3AE0
On memory card	
FM 357-2LX system firmware	6ES7 357-4BH03-3AE0
With additional functions; on memory card	
FM 357-H system firmware	6ES7 357-4CH03-3AE0
With additional functions for the handling sector; on memory card	
FM 357-2 manual	
German	6ES7 357-4AH00-8AG0
English	6ES7 357-4AH00-8BG0
French	6ES7 357-4AH00-8CG0
Italian	6ES7 357-4AH00-8EG0

B) Subject to export regulations: AL: N and ECCN: 4A994

	Order No.
Edit FM	6FC5 263-0AA03-0AB0
Program editor for editing, loading and saving NC programs with the standard programming device/PC; German/English, on CD-ROM	
Connecting cables and encoders	see catalogs NC 60, CA 01 or in the A&D Mall
Front connector	
40-pin, with screw contacts	
• 1 unit	6ES7 392-1AM00-0AA0
• 100 units	6ES7 392-1AM00-1AB0
40-pin, with cage clamp terminals	
• 1 unit	6ES7 392-1BM01-0AA0
• 100 units	6ES7 392-1BM01-1AB0
Back-up battery	6ES7 971-1AA00-0AA0
Li-Ion, 3.6 V/0.95 Ah	
Signal cable	
Pre-assembled for SSI absolute encoder, UL/DESINA	6FX5 0 2-2CC11-■■■■■
Pre-assembled for TTL encoder 6FX2001-1, UL/DESINA	6FX5 0 2-2CD01-■■■■■
Pre-assembled for TTL encoder 24 V, UL/DESINA	6FX5 0 2-2CD24-■■■■■
Length code	see FM 351, page 4/154

SIMATIC S7-300

Function modules

Power section FM STEPDRIVE

www.DataSheet4U.com

Overview



The FM STEPDRIVE Power Module controls the motion of the stepper motors in the SIMOSTEP 1FL3 series with the utmost precision. In combination with the SINUMERIK 802S base line/802S manual machine controls and SIMOTION C230-2 or FM 353 and FM 357-2 Function Modules as well as the SIMATIC ET 200S Stepper Modules 1 STEP, it performs highly accurate positioning tasks in the lower output range up to 600 W.

The FM STEPDRIVE can be used for stepper motors with torques in the 2 Nm (1.5 lb-ft) to 15 Nm (11 lb-ft) range.

Technical specifications

	6SN1227-2ED10-0HA0
Product name	FM STEPDRIVE
Supply voltage	115/230 V AC ±20% selectable
Input current, max.	11/5.5 A
Frequency	47 ... 63 Hz
Supply voltage (signals)	24 V DC (20.4 ... 28.8 V)
Input current, max.	1.5 A
DC link voltage	325 V
Pulse interface	5 V signals ¹⁾ 15-pin sub D socket, standard cable
Signal interface	24 V, I/O signals ¹⁾
Motor connection	3 x 325 V (connected to supply system)
Phase current	1.7 ... 6.8 A (adjustable on unit)
Max. cable length	50 m (164 ft) with 1.5 mm ² 30 m (98.43 ft) with 0.75 mm ²
Terminals for max.	2.5 mm ²
Number of steps/revolution	Adjustable to: 500, 1000, 5000, 10000
Degree of protection EN 60529 (IEC 60529)	IP20, must be installed in cabinet
Condensation	not permissible
Ambient temperature	
• Storage	-40 ... +70 °C (-40 ... 158 °F)
• Transport	-40 ... +70 °C (-40 ... 158 °F)
• Operation	0 ... 60 °C (32 °F ... 140 °F) with derating and dependent on mounting position
Weight, approx.	0.85 kg (1.87 lb)
Dimensions	
• Width	80 mm (3.15 in)
• Height	125 mm (4.92 in)
• Depth	118 mm (4.65 in)

1) Enable signal (enabling of power section), either 5 V via pulse interface or 24 V via signal interface.

Ordering data

Order No.

FM STEPDRIVE Power section for SIMOSTEP stepper motors	6SN1227-2ED10-0HA0
Sub D connector (3 units) 15-pin socket (mating connector)	6FC9348-7HX

Accessories

Filter ²⁾

- 115 V single-phase with neutral conductor;
type: B84142-B16-R
- 230 V single-phase with neutral conductor;
type: B84142-B16-R
- 115 V three-phase with neutral conductor;
type: B84299-K55
- 230 V three-phase with neutral conductor;
type: B84299-K53
- 230 V three-phase without neutral conductor;
type: B84143-B8-R

RS Components GmbH

213-8400

213-8400

213-8090

213-8084

213-8270

2) Can be ordered from RS Components GmbH.

SIMATIC S7-300

Function modules

1FL3 stepper motors

Overview



Stepper motors are functionally simple servomotors. In terms of performance and economy, these motors are the ideal supplement to the position controlled motors 1FT and 1FK. The applications in automation systems are varied, and are not restricted to machine tools.

The SIMOSTEP stepper motor can be operated via the FM STEPDRIVE power section. This converts the stepping and direction signals of the upstream controller into exact angular movements by appropriate current feeding to the motor windings.

SIMOSTEP 1FL3 with holding brake (optional)

The holding brake normally fixes the position after the motor current has been switched off. In emergencies, such as after power failure or EMERGENCY STOP, it stops the drive and thus helps to maintain safety. Fixing is mainly required in case of torque load resulting from weight forces, e.g. Z axes in robotics (vertical axis).

4

Technical specifications

SIMOSTEP 1FL3	
Type of motor	3-phase stepper motor
Motor voltage	325 V
Insulation EN 60034-1 (IEC 60034-1)	Temperature class F for a winding overheating of $\Delta T = 100$ K at an ambient temperature of $+40$ °C (104 °F).
Type DIN 42950	IM B5 (IM V1, IM V3)
Degree of protection IEC 60529	IP56; IP41 at shaft outlet
Cooling	Natural cooling
Permissible ambient temperature	
• Storage and transport	$-40 \dots +70$ °C ($-40 \dots +158$ °F)
• Operation	$0 \dots +40$ °C (32 ... 104 °F)
Max. pulse frequency	5.3 kHz (with 1FL3 04.)
Number of steps/revolution	4.3 kHz (with 1FL3 06.)
Max. speed	500/1000/5000/10000 adjustable via FM STEPDRIVE
Step angle in degrees	6000 rpm
Systematic angle tolerance (measured at 1000 steps/revolution)	$0.72^\circ/0.36^\circ/0.072^\circ/0.036^\circ$
Shaft end	± 6 per step
Permissible dynamic shaft load	Plain shaft with 1FL304. Fitted key with 1FL306.
• Axial, approx.	60 N (13.49 lbf)
• Radial, approx.	(on half-shaft output, engaged from the motor flange) 100 N (22.48 lbf) (with 1FL3041, 1FL3042) 110 N (24.73 lbf) (with 1FL3043) 300 N (67.44 lbf) (with 1FL3061, 1FL3062)

SIMOSTEP 1FL3	
Rotational accuracy, concentricity, and linear movement DIN 42955 (IEC 60072-1)	Tolerance N (Normal)
Vibration severity EN 60034-14 (IEC 60034-14)	Grade N (Normal)
Max. sound pressure level EN ISO 1680	1FL3041: 65 dB(A) 1FL3042: 72 dB(A) 1FL3043: 75 dB(A) 1FL3061: 69 dB(A) 1FL3062: 72 dB(A)
Shock load DIN 40046, T7	1FL304.: 50 g (1.76 oz) 1FL306.: 50 g (1.76 oz)
Paint finish	Black
Type of connection	Terminal box

Holding brake		
Motor type	1FL304.	1FL306.
Rated voltage	24 V	
Minimum holding voltage for released brake	10 V (at the earliest 130 ms after excitation)	
Electrical pickup power	24 W	32 W
Switching times		
• Release brake	35 ms	65 ms
• Close brake	15 ms	15 ms
Type of connection	Connector (mating connector in scope of supply)	

SIMATIC S7-300

Function modules

1FL3 stepper motors

Selection and ordering data

Maximum torque	Holding torque		1FL3 stepper motors SIMOSTEP	Rated current Supply cable	Resistance (winding)	Rotor moment of inertia		Weight	
	Motor	Brakes				without	with	without	with
						holding brake		holding brake	
M_{max}	M_H	M_H	Order No.	I	R	J	J	m	m
Nm (lb-in)	Nm (lb-in)	Nm (lb-in)		A	W	kgcm ²	kgcm ²	kg (lb)	kg (lb)
2 (17.70)	2.26 (20.00)	–	1FL3 041-0AC31-0BK0	1.75	6.5	1.1	–	2.05	–
2 (17.70)	2.26 (20.00)	6 (53.10)	1FL3 041-0AC31-0BJ0	1.75	6.5	–	1.3	–	3.4
4 (35.40)	4.52 (40.01)	–	1FL3 042-0AC31-0BK0	2	5.8	2.2	–	3.1	–
4 (35.40)	4.52 (40.01)	6 (53.10)	1FL3 042-0AC31-0BJ0	2	5.8	–	2.4	–	4.45
6 (53.10)	6.78 (60.01)	–	1FL3 043-0AC31-0BG0	2.25	6.5	3.3	–	4.2	–
6 (53.10)	6.78 (60.01)	6 (53.10)	1FL3 043-0AC31-0BH0	2.25	6.5	–	3.5	–	5.55
10 (88.51)	11.3 (100.01)	–	1FL3 061-0AC31-0BG0	4.1	1.8	10.5	–	8	–
10 (88.51)	11.3 (100.01)	16 (141.61)	1FL3 061-0AC31-0BH0	4.1	1.8	–	10.85	–	10.2
15 (132.76)	16.95 (150.02)	–	1FL3 062-0AC31-0BG0	4.75	1.9	16	–	11	–
15 (132.76)	16.95 (150.02)	16 (141.61)	1FL3 062-0AC31-0BH0	4.75	1.9	–	16.35	–	13.2

For length code as well as power and signal cables, see "MOTION-CONNECT cables and connections".

Ordering data

Order No.

Order No.

1FL3 stepper motors SIMOSTEP

- 2 Nm, shaft diameter 12 mm
- 4 Nm, shaft diameter 12 mm
- 6 Nm
- 10 Nm
- 15 Nm

1FL3 041-0AC31-0BK0
1FL3 042-0AC31-0BK0
1FL3 043-0AC31-0BG0
1FL3 061-0AC31-0BG0
1FL3 062-0AC31-0BG0

with holding brake

- 2 Nm, shaft diameter 12 mm
- 4 Nm, shaft diameter 12 mm
- 6 Nm
- 10 Nm
- 15 Nm

1FL3 041-0AC31-0BJ0
1FL3 042-0AC31-0BJ0
1FL3 043-0AC31-0BH0
1FL3 061-0AC31-0BH0
1FL3 062-0AC31-0BH0

Motor cable

Power cable,
4 x 1.5 C UL/CSA;
sold by the meter,
max. 50 m

6FX5 008-1BB11-1FA0

SIMATIC S7-300

Function modules

FM 355 closed-loop control module

4

Overview



- 4-channel closed-loop control module for universal closed-loop control tasks
- Used for temperature, pressure, flowrate and fill-level control loops
- User-friendly online self-optimization for temperature controls
- Preprogrammed controller structures
- 2 control algorithms
- 2 versions:
 - FM 355 C as continuous-action controller;
 - FM 355 S as step or pulse controller
- With 4 analog outputs (FM 355 C) or 8 digital outputs (FM 355 S) for direct control of the most common types of actuator
- Continued operation of the control loop is possible even after a CPU stop or failure

Technical specifications

	6ES7 355-0VH10-0AE0	6ES7 355-1VH10-0AE0
Voltages and currents		
Load voltage L+		
• Rated value (DC)	24 V	24 V
• permissible range, lower limit (DC)	20.4 V	20.4 V
• permissible range, upper limit (DC)	28.8 V	28.8 V
Current consumption		
from load voltage L+ (without load), max.	310 mA; typ. 260 mA	270 mA; typ. 220 mA
from backplane bus DC 5 V, max.	75 mA; typ. 50 mA	75 mA; typ. 50 mA
Power loss, max.	7.8 W	6.9 W
Power loss, typ.	6.5 W	5.5 W
Connection point		
required front connectors	2 x 20-pin	2 x 20-pin
Digital inputs		
Number of digital inputs	8	8
Cable length		
• Cable length, shielded, max.	1,000 m	1,000 m
• Cable length unshielded, max.	600 m	600 m
Input characteristic curve to IEC 1131, type 2	Yes	Yes
Input voltage		
• Rated value, DC	24 V	24 V
• for signal "0"	-3 to 5 V	-3 to 5 V
• for signal "1"	13 to 30 V	13 to 30 V
Input current		
• for signal "1", typ.	7 mA	7 mA
Digital outputs		
Number of digital outputs		8
Cable length, shielded, max.		1,000 m

	6ES7 355-0VH10-0AE0	6ES7 355-1VH10-0AE0
Cable length unshielded, max.		600 m
Short-circuit protection of the output		Yes; electronic
Limitation of inductive shutdown voltage to		L+ (-1.5 V)
Lamp load, max.		5 W
Controlling a digital input		Yes
Output voltage		
• for signal "1", min.		L+ (-2.5 V)
Output current		
• for signal "1" rated value		100 mA
• for signal "1" permissible range for 0 to 60 °C, min.		5 mA
• for signal "1" permissible range for 0 to 60 °C, max.		150 mA
• for signal "0" residual current, max.		0.5 mA
Parallel switching of 2 outputs		
• for logic links		Yes
Switching frequency		
• with resistive load, max.		100 Hz
• with inductive load, max.		0.5 Hz
• on lamp load, max.		100 Hz
Aggregate current of the outputs (per group)		
• up to 60 °C, max.		400 mA
Load impedance range		
• lower limit		240 Ω
• upper limit		4 kΩ

SIMATIC S7-300

Function modules

FM 355 closed-loop control module

Technical specifications (continued)

	6ES7 355-0VH10-0AE0	6ES7 355-1VH10-0AE0
Analog inputs		
Number of analog inputs	4	4
Cable length, shielded, max.	200 m; 50m at 80 mV and thermocouples	200 m; 50m at 80 mV and thermocouples
permissible input frequency for voltage input (destruction limit), max.	30 V	30 V
permissible input current for current input (destruction limit), max.	40 mA	40 mA
Input ranges (rated values), voltages		
• 0 to +10 V	Yes	Yes
• -1.75 to +11.75 V	Yes	Yes
• -80 mV to +80 mV	Yes	Yes
Input ranges (rated values), currents		
• 0 to 20 mA	Yes	Yes
• 0 to 23.5 mA	Yes	Yes
• -3.5 to +23.5 mA	Yes	Yes
• 4 to 20 mA	Yes	Yes
Input ranges (rated values), thermoelements		
• Type B	Yes	Yes
• Type J	Yes	Yes
• Type K	Yes	Yes
• Type R	Yes	Yes
• Type S	Yes	Yes
Input ranges (rated values), resistance thermometers		
• Pt 100	Yes	Yes
Characteristic linearization		
• programmable	Yes	Yes
• for thermoelements	Type B, J, K, R, S	Type B, J, K, R, S
• for thermoresistor	Pt 100 (Standard)	Pt 100 (Standard)
Temperature compensation		
• external temperature compensation with Pt100	Yes	Yes
• internal temperature compensation	Yes	Yes
Analog outputs		
Number of analog outputs	4	
Cable length, shielded, max.	200 m; 50m at 80 mV and thermocouples	
Voltage output, short-circuit protection	Yes	
Voltage output, short-circuit current, max..	25 mA	

	6ES7 355-0VH10-0AE0	6ES7 355-1VH10-0AE0
Current output, no-load voltage, max.	18 V	
Output ranges, voltage		
• 0 to 10 V	Yes	
• -10 to +10 V	Yes	
Output ranges, current		
• 0 to 20 mA	Yes	
• 4 to 20 mA	Yes	
Connection of actuators		
• for voltage output 2-conductor connection	Yes	
• for current output 2-conductor connection	Yes	
Load impedance (in rated range of output)		
• with voltage outputs, min.	1 kΩ	
• with voltage outputs, capacitive load, max.	1 μF	
• with current outputs, max.	500 Ω	
• with current outputs, inductive load, max.	1 mH	
Analog value creation		
Measurement principle	integrating	integrating
Integrations and conversion time/resolution per channel		
• Resolution with overload area (bit including sign), max.	14 Bit; 12 or 14 bit, parameterizable	14 Bit; 12 or 14 bit, parameterizable
• Conversion time (per channel)	16.67 ms; for 12 bit: 16 2/3 ms for 60 Hz, 20 ms for 50 Hz; for 14 bit: 100 ms for 50 and 60 Hz	16.67 ms; for 12 bit: 16 2/3 ms for 60 Hz, 20 ms for 50 Hz; for 14 bit: 100 ms for 50 and 60 Hz
Settling time		
• for resistive load	0.2 ms	0.1 ms
• for capacitive load	3.3 ms	3.3 ms
• for inductive load	0.5 ms	0.5 ms
Encoder		
Connection of signal encoders		
• for voltage measurement	Yes	Yes
• for current measurement as 4-wire transducer	Yes	Yes
Connectable encoders		
• 2-wire BEROS	Yes	Yes
• permissible quiescent current (2-wire BEROS), max.	1.5 mA	1.5 mA

Technical specifications (continued)

	6ES7 355-0VH10-0AEO	6ES7 355-1VH10-0AEO
Errors/accuracies		
Linearity error (relative to output area)	+/- 0.05 %	
Linearity error (relative to input area)	+/- 0.05 %	+/- 0.05 %
Temperature error (relative to output area)	+/- 0.02 %/K	
Temperature error (relative to input areas)	+/- 0.005 %/K	+/- 0.005 %/K
Operational limit in overall temperature range		
• Voltage, relative to output area	+/- 0.5 %	
• Current, relative to output area	+/- 0.6 %	
• Voltage, relative to input area	+/- 0.6 % ; +/- 0.6 to +/-1%	+/- 0.6 % ; +/- 0.6 to +/-1%
• Current, relative to input area	+/- 0.6 % ; +/- 0.6 to +/-1%	+/- 0.6 % ; +/- 0.6 to +/-1%
• Resistance-type thermometer, relative to input area	+/- 0.6 % ; +/- 0.6 to +/-1%	+/- 0.6 % ; +/- 0.6 to +/-1%
Basic error limit (operational limit at 25 °C)		
• Voltage, relative to output area	+/- 0.3 %	
• Current, relative to output area	+/- 0.5 %	
• Voltage, relative to input area	+/- 0.4 % ; 80 mV +/- 0.6 % ; from 250 to 1000 mV +/- 0.4 % ; from 2.5 to 10 V +/- 0.6 % ; from 3.2 to 20 mA +/-0.5%	+/- 0.4 % ; 80 mV +/- 0.6 % ; from 250 to 1000 mV +/- 0.4 % ; from 2.5 to 10 V +/- 0.6 % ; from 3.2 to 20 mA +/-0.5%
• Resistance-type thermometer, relative to input area	+/- 0.4 % ; +/-0.4 to +/-0.6%	+/- 0.4 % ; +/-0.4 to +/-0.6%

	6ES7 355-0VH10-0AEO	6ES7 355-1VH10-0AEO
Interference voltage suppression for $f = n \times (f_l \pm 1 \%)$, f_l = interference frequency		
• Series mode interference (peak value of interference < rated value of input range), min.	40 dB	40 dB
• common mode voltage (USS < 2.5 V) , min.	70 dB	70 dB
Control technology		
Number of closed loop controllers	4	4
Status information/alarms/diagnostics		
Substitute values connectable	Yes; parameterizable	Yes; parameterizable
Isolation		
Isolation checked with	500 V DC	500 V DC
Isolation		
Isolation, controller		
• between the channels	No	No
• between the channels and the backplane bus	Yes; Optocoupler	Yes; Optocoupler
Permissible potential difference		
between inputs and MANA (UCM)	2.5 V DC	2.5 V DC
between M internal and the inputs	75 V DC/ 60 V AC	75 V DC/ 60 V AC
Dimensions and weight		
Width	80 mm	80 mm
Height	125 mm	125 mm
Depth	120 mm	120 mm
Weights		
Weight, approx.	470 g	470 g

Ordering data

	Order No.
FM 355 C closed-loop control module	6ES7 355-0VH10-0AEO
With 4 analog outputs for 4 continuous-action controllers	
FM 355 S closed-loop control module	6ES7 355-1VH10-0AEO
With 8 digital outputs for 4 sequence or pulse controllers	
Front connector	
20-pole, screw-type contacts	
• 1 unit	6ES7 392-1AJ00-0AA0
• 100 units	6ES7 392-1AJ00-1AB0
20-pin, with cage clamp terminals	
• 1 unit	6ES7 392-1BJ00-0AA0
• 100 units	6ES7 392-1BJ00-1AB0
Bus connector	
1 units (spare part)	6ES7 390-0AA00-0AA0
Labeling strips	
10 units (spare part)	6ES7 392-2XX00-0AA0

	Order No.
S7 SmartLabel	2XV9 450-1SL01-0YX0
Software for labeling modules mechanically directly in the STEP 7 project	
Sheets of labels for machine inscription	see "Accessories", page 4/240
Mounting location number plate	6ES7 912-0AA00-0AA0
Spare part	
Shield connecting element	6ES7 390-5AA00-0AA0
80 mm wide, with 2 rows of 4 terminals	
Terminal elements	
2 items	
For 2 cables of 2 to 6 mm in diameter	6ES7 390-5AB00-0AA0
For 1 cable of 3 to 8 mm in diameter	6ES7 390-5BA00-0AA0
For 1 cable of 4 to 13 mm in diameter	6ES7 390-5CA00-0AA0

SIMATIC S7-300

Function modules

FM 355-2 temperature control module

www.DataSheet4U.com

Overview



- 4-channel closed-loop controller module specifically for temperature controls
- Including integrated and easy-to-use online self-optimization
- Heating and cooling controllers as well as combined controllers with heating and active cooling function feasible
- Ready-to-use controller structures
- 2 versions:
 - FM 355-2 C as a continuous controller;
 - FM 355-2 S as step or pulse controllers
- With 4 analog outputs (FM 355-2 C) or 8 digital inputs (FM 355-2 S) to directly control the most common final control elements
- It is possible to continue closed-loop control operation even if the CPU stops or fails

Technical specifications

	6ES7 355-2CH00-0AE0	6ES7 355-2SH00-0AE0
Voltages and currents		
Load voltage L+		
• Rated value (DC)	24 V	24 V
• permissible range, lower limit (DC)	20.4 V	20.4 V
• permissible range, upper limit (DC)	28.8 V	28.8 V
Current consumption		
from load voltage L+ (without load), max.	310 mA; typ. 260 mA	270 mA; typ. 220 mA
from backplane bus DC 5 V, max.	75 mA; typ. 50 mA	75 mA; typ. 50 mA
Power loss, max.	7.8 W	6.9 W
Power loss, typ.	6.5 W	5.5 W
Connection point		
required front connectors	2 x 20-pin	2 x 20-pin
Digital inputs		
Number of digital inputs	8	8
Cable length		
• Cable length, shielded, max.	1,000 m	1,000 m
• Cable length unshielded, max.	600 m	600 m
Input characteristic curve to IEC 1131, type 2	Yes	Yes
Input voltage		
• Rated value, DC	24 V	24 V
• for signal "0"	-3 to 5 V	-3 to 5 V
• for signal "1"	13 to 30 V	13 to 30 V
Input current		
• for signal "1", typ.	7 mA	7 mA
Digital outputs		
Number of digital outputs		8
Cable length, shielded, max.		1,000 m
Cable length unshielded, max.		600 m

	6ES7 355-2CH00-0AE0	6ES7 355-2SH00-0AE0
Short-circuit protection of the output		Yes; electronic
Limitation of inductive shutdown voltage to		L+ (-1.5 V)
Lamp load, max.		5 W
Controlling a digital input		Yes
Output voltage		
• for signal "1", min.		L+ (-2.5 V)
Output current		
• for signal "1" rated value		0.1 A
• for signal "1" for 0 to 60 °C, min.		5 mA
• for signal "1" permissible range for 0 to 60 °C, max.		150 mA
• for signal "0" residual current, max.		0.5 mA
Parallel switching of 2 outputs		
• for logic links		Yes
Switching frequency		
• with resistive load, max.		100 Hz
• with inductive load, max.		0.5 Hz
• on lamp load, max.		100 Hz
Aggregate current of the outputs (per group)		
• up to 60 °C, max.		400 mA
Load impedance range		
• lower limit		240 Ω
• upper limit		4 kΩ
Analog inputs		
Number of analog inputs	4	4
Cable length, shielded, max.	200 m; 50m at 80 mV and thermocouples	200 m; 50m at 80 mV and thermocouples

www.DataSheet4U.com

www.DataSheet4U.com
Technical specifications (continued)

	6ES7 355-2CH00-0AE0	6ES7 355-2SH00-0AE0
permissible input frequency for voltage input (destruction limit), max.	20 V	20 V
permissible input current for current input (destruction limit), max.	40 mA	40 mA
Input ranges (rated values), voltages		
• 0 to +10 V	Yes	Yes
• -1.75 to +11.75 V	Yes	Yes
Input ranges (rated values), currents		
• 0 to 20 mA	Yes	Yes
• 0 to 23.5 mA	Yes	Yes
• -3.5 to +23.5 mA	Yes	Yes
• 4 to 20 mA	Yes	Yes
Input ranges (rated values), thermoelements		
• Type B	Yes	Yes
• Type E	Yes	Yes
• Type J	Yes	Yes
• Type K	Yes	Yes
• Type R	Yes	Yes
• Type S	Yes	Yes
Input ranges (rated values), resistance thermometers		
• Pt 100	Yes	Yes
Characteristic linearization		
• programmable	Yes	Yes
• for thermoelements	Type B, E, J, K, R, S	Type B, E, J, K, R, S
• for thermoresistor	Pt 100 (Standard)	Pt 100 (Standard)
Temperature compensation		
• external temperature compensation with Pt100	Yes	Yes
• internal temperature compensation	Yes	Yes
Analog outputs		
Number of analog outputs	4	
Cable length, shielded, max.	200 m; 50m at 80 mV and thermocouples	
Voltage output, short-circuit protection	Yes	
Voltage output, short-circuit current, max..	25 mA	
Current output, no-load voltage, max.	18 V	
Output ranges, voltage		
• 0 to 10 V	Yes	
• -10 to +10 V	Yes	

	6ES7 355-2CH00-0AE0	6ES7 355-2SH00-0AE0
Output ranges, voltage		
• 0 to 10 V	Yes	
• -10 to +10 V	Yes	
Connection of actuators		
• for voltage output 2-conductor connection	Yes	
• for current output 2-conductor connection	Yes	
Load impedance (in rated range of output)		
• with voltage outputs, min.	1 kΩ	
• with voltage outputs, capacitive load, max.	1 μF	
• with current outputs, max.	500 Ω	
• with current outputs, inductive load, max.	1 mH	
Analog value creation		
Measurement principle	integrating	integrating
Integrations and conversion time/resolution per channel		
• Resolution with overload area (bit including sign), max.	14 Bit	14 Bit
• Conversion time (per channel)	100 ms; at 50 and 60 Hz	100 ms; at 50 and 60 Hz
Settling time		
• for resistive load	0.2 ms	0.1 ms
• for capacitive load	3.3 ms	3.3 ms
• for inductive load	0.5 ms	0.5 ms
Encoder		
Connection of signal encoders		
• for voltage measurement	Yes	Yes
• for current measurement as 4-wire transducer	Yes	Yes
Connectable encoders		
• 2-wire BEROS	Yes	Yes
• permissible quiescent current (2-wire BEROS), max.	1.5 mA	1.5 mA
Errors/accuracies		
Linearity error (relative to output area)	+/- 0.05 %	
Linearity error (relative to input area)	+/- 0.05 %	+/- 0.05 %
Temperature error (relative to output area)	+/- 0.02 %/K	
Temperature error (relative to input areas)	+/- 0.005 %/K	+/- 0.005 %/K
Operational limit in overall temperature range		
• Voltage, relative to output area	+/- 0.5 %	

SIMATIC S7-300

Function modules

FM 355-2 temperature control module

Technical specifications (continued)

	6ES7 355-2CH00-0AE0	6ES7 355-2SH00-0AE0
Operational limit in overall temperature range		
• Current, relative to output area	+/- 0.6 %	
• Voltage, relative to input area	+/- 0.6 %; +/-0.6 to +/-0.7%	+/- 0.06 %; +/-0.06 to +/-0.7%
• Current, relative to input area	+/- 0.6 %; +/-0.6 to +/-0.7%	+/- 0.06 %; +/-0.06 to +/-0.7%
• Resistance-type thermometer, relative to input area	+/- 0.6 %; +/-0.6 to +/-0.7%	+/- 0.06 %; +/-0.06 to +/-0.7%
Basic error limit (operational limit at 25 °C)		
• Voltage, relative to output area	+/- 0.4 %	
• Current, relative to output area	+/- 0.5 %	
• Voltage, relative to input area	+/- 0.04 %; +/-0.04 to +/-0.5%	+/- 0.04 %; +/-0.04 to +/-0.5%
• Current, relative to input area	+/- 0.04 %; +/-0.04 to +/-0.5%	+/- 0.04 %; +/-0.04 to +/-0.5%
• Resistance-type thermometer, relative to input area	+/- 0.04 %; +/-0.04 to +/-0.5%	+/- 0.04 %; +/-0.04 to +/-0.5%
Interference voltage suppression for $f = n \times (fl \pm 1 \%)$, $fl =$ interference frequency		
• Series mode interference (peak value of interference < rated value of input range), min.	40 dB	40 dB
• common mode voltage (USS < 2.5 V) , min.	70 dB	70 dB

	6ES7 355-2CH00-0AE0	6ES7 355-2SH00-0AE0
Control technology		
Number of closed loop controllers	4	4
Status information/alarms/diagnostics		
Substitute values connectable	Yes; parameterizable	Yes; parameterizable
Isolation		
Isolation checked with	500 V DC	500 V DC
Isolation		
Isolation, controller		
• between the channels	No	No
• between the channels and the backplane bus	Yes; Optocoupler	Yes; Optocoupler
Permissible potential difference		
between inputs and MANA (UCM)	2.5 V DC	2.5 V DC
between M internal and the inputs	75 V DC/ 60 V AC	75 V DC/ 60 V AC
Dimensions and weight		
Width	80 mm	80 mm
Height	125 mm	125 mm
Depth	120 mm	120 mm
Weights		
Weight, approx	470 g	470 g

Ordering data

	Order No.
FM 355-2 C temperature controller module	6ES7 355-2CH00-0AE0
With 4 analog outputs for 4 continuous-action controllers	
FM 355-2 S temperature controller module	6ES7 355-2SH00-0AE0
With 8 digital outputs for 4 step or pulse controllers	
Front connector	
20-pin, with screw-type terminals	
• 1 unit	6ES7 392-1AJ00-0AA0
• 100 units	6ES7 392-1AJ00-1AB0
20-pin, with cage clamp terminals	
• 1 unit	6ES7 392-1BJ00-0AA0
• 100 units	6ES7 392-1BJ00-1AB0
Bus connector	6ES7 390-0AA00-0AA0
1 unit (spare part)	
Labeling strip	6ES7 392-2XX00-0AA0
10 units (spare part)	

Order No.

S7-SmartLabel	2XV9 450-1SL01-0YX0
Software for machine labeling of modules directly from the STEP 7 project	
Labeling sheets for machine labeling	see "Accessories", page 4/240
Slot number label	6ES7 912-0AA00-0AA0
Spare part	
Shield connecting element	6ES7 390-5AA00-0AA0
80 mm wide, with 2 rows for 4 terminal elements each	
Terminal elements	
2 units	
For 2 cables with 2 to 6 mm diameter	6ES7 390-5AB00-0AA0
For 1 cable with 3 to 8 mm diameter	6ES7 390-5BA00-0AA0
For 1 cable with 4 to 13 mm diameter	6ES7 390-5CA00-0AA0

SIMATIC S7-300

Function modules

SM 338 POS input module

4

www.DataSheet4U.com

Overview



- Interface between a maximum of 3 absolute position encoders (SSI) and the CPU.
- To provide the position-encoder values for subsequent processing in the STEP 7 program.
- Enables the programmable controller's direct response to encoder values in moving systems.

Note:

SIMODRIVE Sensor/Motion Connect 500 feature position-measuring systems and preassembled connecting cables for counting and positioning functions.

Additional information is available in the Internet under:

<http://www.siemens.com/simatic-technology>

Technical specifications

	6ES7 338-4BC01-0AB0
Voltages and currents	
Load voltage L+	
• Rated value (DC)	24 V
• permissible range, lower limit (DC)	20.4 V
• permissible range, upper limit (DC)	28.8 V
Current consumption	
from load voltage L+ (without load), max.	10 mA
from backplane bus DC 5 V, max.	160 mA
Power loss, typ.	3 W
Connection point	
required front connectors	20-pin
Digital inputs	
Cable length	
• Cable length, shielded, max.	600 m
Input voltage	
• for signal "0"	-3 to 5 V
• for signal "1"	11 to 30.2 V
Input current	
• for signal "0", max. (permissible quiescent current)	2 mA
• for signal "1", typ.	9 mA
Input delay (for rated value of input voltage)	
• for standard inputs - at "0" to "1", min.	300 µs

	6ES7 338-4BC01-0AB0
Encoder supply	
24 V encoder supply	
• 24 V	Yes; L+ (-0.8 V)
• Output current, max.	900 mA
Encoder	
Number of connectable encoders, max.	3
Connectable encoders	
• Absolute encoder (SSI)	Yes
• 2-wire BEROS	Yes
Encoder signals, absolute encoder (SSI)	
• Cable length, shielded, max.	320 m; 320 m at 125 kHz, 160 m at 250 kHz, 60 m at 500 kHz, 20 m at 1 MHz
Status information/alarms/diagnostics	
Alarms	
• Diagnostic alarm	Yes
Isolation	
Galvanic isolation	No
Dimensions and weight	
Width	40 mm
Height	125 mm
Depth	120 mm
Weights	
Weight, approx.	235 g

SIMATIC S7-300

Function modules

SM 338 POS input module

www.DataSheet4U.com

Ordering data	Order No.	Ordering data	Order No.
SM 338 POS input module For position sensing with ultrasonic encoders with Start/Stop interface	6ES7 338-4BC01-0AB0	SIMATIC Manual Collection update service for 1 year ^{D)} Current "Manual Collection" DVD and the three subsequent updates	6ES7 998-8XC01-8YE2
Front connector 20-pin, with screw contacts <ul style="list-style-type: none"> • 1 unit • 100 units 20-pin, with cage clamp terminals <ul style="list-style-type: none"> • 1 unit • 100 units 	6ES7 392-1AJ00-0AA0 6ES7 392-1AJ00-1AB0 6ES7 392-1BJ00-0AA0 6ES7 392-1BJ00-1AB0	S7-300 manual Design, CPU data, module data, instruction list German English French Spanish Italian	6ES7 398-8FA10-8AA0 6ES7 398-8FA10-8BA0 6ES7 398-8FA10-8CA0 6ES7 398-8FA10-8DA0 6ES7 398-8FA10-8EA0
Front door, elevated design ^{A)} e.g. for 32-channel modules; for connecting 1.3 mm ² /16 AWG conductors	6ES7 328-0AA00-7AA0	Signal cable Pre-assembled for SSI absolute encoder 6FX2001-5, without Sub-D connector, UL/DESINA Length code	6FX5 002-2CC12-■■■■■ see FM 351, page 4/154
SIMATIC Manual Collection ^{D)} Electronic manuals on DVD, multilingual: S7-200, S7-300, C7, S7-400, SIMATIC DP (Distributed I/O), SIMATIC PC, SIMATIC PG (Programming device), STEP 7, Engineering Tools, Runtime Software, SIMATIC PCS 7, SIMATIC HMI (Human Machine Interface), SIMATIC NET (Industrial Communication), SIMATIC Machine Vision, SIMATIC Sensors	6ES7 998-8XC01-8YE0		

A) Subject to export regulations: AL: N and ECCN: EAR99H

D) Subject to export regulations: AL: N and ECCN: 5D992B1

SIMATIC S7-300

Function modules

IM 174 PROFIBUS module

4

www.DataSheet4U.com

Overview



- For connecting up to 4 drives with analog setpoint interface or pulse-direction interface to a motion control
- Operation with isochronous PROFIBUS DP
- Connectable drives:
 - electrical drives
 - hydraulic drives
 - stepper drives
- Can be used with SIMATIC CPU 31xT-2 DP, SIMATIC Microbox 420-T, SIMOTION C230-2, SIMOTION P350, SIMOTION D4x5
- Can also be used with external encoders

Technical specifications

	6ES7 174-0AA00-0AA0
Supply voltages	
Rated value	
• DC 24 V	Yes
• permissible range, lower limit (DC)	20.4 V
• permissible range, upper limit (DC)	28.8 V
Current consumption	
Current consumption, max.	500 mA
Power loss, typ.	12 W
Connection point	
required front connectors	40-pin
Isochronous mode	
Isochronous mode	Yes
shortest clock pulse	1.5 ms
Digital inputs	
Number of digital inputs	10
Cable length	
• Cable length, shielded, max.	100 m
Input voltage	
• for signal "0"	-3 to 5 V
• for signal "1"	15 to 30 V
Input current	
• for signal "0", max. (permissible quiescent current)	3 mA
• for signal "1", typ.	6 mA
Input delay (for rated value of input voltage)	
• for standard inputs - at " to "1", min.	15 µs
Digital outputs	
Number of digital outputs	8
Cable length, shielded, max.	600 m
Short-circuit protection of the output	Yes

	6ES7 174-0AA00-0AA0
Switching capacity of the outputs	
• with resistive load, max.	0.5 A
• on lamp load, max.	5 W
Output voltage	
• Rated value (DC)	24 V; L+
• for signal "1", min.	L+ (-3 V)
• for signal "1" (DC), max.	24 V; max. value is equal to feed L+
Output current	
• for signal "1" permissible range for 0 to 60 °C, min.	5 mA
• for signal "1" permissible range for 0 to 60 °C, max.	500 mA
• for signal "0" residual current, max.	0.4 mA
Output delay with resistive load	
• "0" to "1", max.	500 µs
Switching frequency	
• with resistive load, max.	100 Hz
• with inductive load, max.	1 Hz
Relay outputs	
Number of operating cycles	500,000
Switching capacity of the contacts	
• with resistive load, max.	1 A
Analog outputs	
Number of analog outputs	4
Output ranges, voltage	
• -10 to +10 V	Yes
Analog value creation	
Integrations and conversion time/resolution per channel	
• Resolution with overload area (bit including sign), max.	15 Bit

SIMATIC S7-300

Function modules

IM 174 PROFIBUS module

Technical specifications (continued)

	6ES7 174-0AA00-0AA0
Encoder supply	
5 V encoder supply	
• 5 V	Yes
• Output current, max.	1.2 A
24 V encoder supply	
• 24 V	Yes
• Output current, max.	1.4 A
Absolute encoder (SSI) encoder supply	
• Absolute encoder (SSI)	Yes
• Short-circuit protection	Yes
Encoder	
Number of connectable encoders, max.	4
Connectable encoders	
• Incremental encoder (symmetrical)	Yes
• Absolute encoder (SSI)	Yes
Encoder signals, incremental encoder (symmetrical)	
• Trace mark signals	A, notA, B, notB
• Zero mark signal	N, notN
• Input signal	5 V difference signal (phys. RS 422)
• Input frequency, max.	1 MHz
• Cable length, shielded, max.	35 m; 35 m at max. 500 kHz; 10 m at max. 1 MHz

	6ES7 174-0AA00-0AA0
Encoder signals, absolute encoder (SSI)	
• Input signal	5 V difference signal (phys. RS 422)
• Data signal	DATA, notDATA
• Clock signal	CLS, notCLS
• Telegram length	13, 21, 25 bit
• Clock frequency, max.	3 MHz; 187.5 KHz to 3.0 MHz (parameterizable)
• Gray code	Yes
• Cable length, shielded, max.	250 m; 250 m at 187.5 kHz, 10 m at 1.5 MHz
Isolation	
Isolation, digital outputs	
• Galvanic isolation, digital outputs	Yes
Galvanic isolation, digital inputs	
• galvanic isolation, digital inputs	Yes
Dimensions and weight	
Width	160 mm
Height	125 mm
Depth	118 mm
Weights	
Weight, approx.	1 kg

Ordering data

	Order No.
IM 174 PROFIBUS module A)	6ES7 174-0AA00-0AA0
PROFIBUS module for connecting analog drives and stepper drives to motion controllers	

A) Subject to export regulations: AL: N and ECCN: EAR99H

Order No.

www.DataSheet4U.com
Overview

SIWAREX U weighing electronics

SIWAREX U is a versatile weighing module for all simple weighing and force measuring tasks. The compact module is easy to install in all SIMATIC automation systems. Complete data access is then possible via the SIMATIC.

Technical specifications

SIWAREX U	
Integration in automation systems:	
• S5-95U/DP (PROFIBUS master)	Via ET 200M
• S5-115U/-135U/-155U	Via ET 200M
• S7-300	Direct integration
• S7-400	Via ET 200M
• PCS 7	Via ET 200M
• M7-300	Direct integration
• M7-400	Via ET 200M
• C7	Via IM or ET 200M
• Automation systems from other vendors	Via ET 200M
• Stand-alone (without SIMATIC CPU)	Possible with IM 153-1
Communication interfaces	<ul style="list-style-type: none"> • SIMATIC S7 (P bus) • RS 232 • TTY
Connection of remote indicators (through TTY serial interface)	Gross, channel 1, 2 or default value 1, 2
Adjustment of scales settings	Using SIMATIC S5/S7/M7/C7 (P bus) or SIWATOOL U parameterization software (RS 232)
Measuring properties	
• Error limit according to DIN 1319-1 of full-scale value at 20 °C ± 10 K	0.05 %
• Internal resolution Data format of weight values	65.535 2 byte (fixed-point)
Number of measurements/second	50
Digital filter	0.05 - 5 Hz (in 7 steps), mean-value filter
Weighing functions	
• Weight values	Gross
• Limits	2 (min./max.)
• Zero setting function	Per command
Load cells	Strain gauges in 4-wire or 6-wire system

SIWAREX U	
Load cell powering	
• Supply voltage U_s (rated value)	10.3 V DC
• Max. supply current	≤ 240 mA single-channel ≤ 120 mA two-channel
• Permissible load resistance (per weighing channel)	
- R_{Lmin}	> 41 Ω single-channel > 82 Ω two-channel
- R_{Lmax}	< 4010 Ω
-	With Ex(i) interface:
- R_{Lmin}	> 87 Ω
- R_{Lmax}	< 4010 Ω
Permissible load cell characteristic	Up to 4 mV/V
Permissible range of measuring signal (at greatest set characteristic)	-1.5 to +42.5 mV
Max. distance of load cells	1000 m (300 m in Ex area (up to 1000 m, depending on the gas group))
Intrinsically-safe load cell powering	Optional (Ex interface)
Supply voltage 24 V DC	
• Rated voltage	24 V DC
• Max. current consumption	220 mA
Voltage supply from backplane bus	typ. 100 mA
Certification	UL, CSA, FM
IP degree of protection to DIN EN 60 529; IEC 60 529	IP20
Climatic requirements	
$T_{min}(IND)$ to $T_{max}(IND)$ (operating temperature)	
• Vertical installation	0 ... +60 °C
• Horizontal installation	0 ... +40 °C
EMC requirements according to	NAMUR NE21, Part 1 89/386/EEC

SIMATIC S7-300

Function modules

SIWAREX U

4

Ordering data	Order No.	Order No.
SIWAREX U for SIMATIC S7 and ET 200M, incl. bus connector, weight 0.3 kg		
<ul style="list-style-type: none"> Single-channel version for connecting one scale A) 7MH4 601-1AA01 Two-channel version for connecting two scales A) 7MH4 601-1BA01 		
SIWAREX U Manual <ul style="list-style-type: none"> German, English, French Free download on the Internet at: www.siemens.com/weighing-technology		
SIWAREX U configuration package for SIMATIC S5/S7 version 5.1 or higher on CD-ROM <ul style="list-style-type: none"> SIWATOOL U PC parameterization software (German/English/French/Italian) Example programs SIWAREX U manual on CD (in German and English) Setup for incorporation of SIWAREX U into STEP 7 	7MH4 683-3AA63	
SIWAREX U configuration package for PCS 7, version 5.2	7MH4 683-3BA63	
SIWAREX U configuration package for PCS 7, version 6.x in German and English on CD-ROM Block for the CFC and faceplate	7MH4 683-3BA64	
SIWATOOL cable A) from SIWAREX U/CS with serial PC interface, for 9-pin PC interfaces (RS 232), 3 m long	7MH4 607-8CA	
Installation material (mandatory)		
20-pin front plug with screw contacts (required for each SIWAREX module)	6ES7 392-1AJ00-0AA0	
Shield contact element Sufficient for two SIWAREX U modules	6ES7 390-5AA00-0AA0	
Shield connection terminal Contents: 2 units (suitable for cable with diameter 4 to 13 mm) Note: one shield connection terminal is required each for: <ul style="list-style-type: none"> Scale connection RS 485 interface RS 232 interface 	6ES7 390-5CA00-0AA0	
S7 DIN rail <ul style="list-style-type: none"> 160 mm 6ES7 390-1AB60-0AA0 480 mm 6ES7 390-1AE80-0AA0 530 mm 6ES7 390-1AF30-0AA0 830 mm 6ES7 390-1AJ30-0AA0 2000 mm 6ES7 390-1BC00-0AA0 		
		Accessories (optional)
		PS 307 load power supplies (only required if DC 24 V is not available) 120/230 V AC; 24 V DC, incl. power connector PS 307-1B; 2 A 6ES7 307-1BA00-0AA0 PS 307-1E; 5 A 6ES7 307-1EA00-0AA0 PS 307-1K; 10 A 6ES7 307-1KA00-0AA0
		Labeling strips (10 units, spare part) 6ES7 392-2XX00-0AA0 Remote displays (option) The digital remote displays can be connected directly to SIWAREX U through a TTY interface. The following remote displays can be used: S102, S302 <i>Siebert Industrieelektronik GmbH</i> <i>P.O. Box 1180</i> <i>D-66565 Eppelborn</i> <i>Tel.: +49 6806/980-0</i> <i>Fax: +49 6806/980-999</i> <i>Internet: http://www.siebert.de</i> Detailed information available from manufacturer.
		SIWAREX JB junction box, aluminium housing 7MH4 710-1BA for connecting up to 4 load cells in parallel, and for connecting several junction boxes
		SIWAREX JB junction box, stainless steel housing 7MH4 710-1EA for connecting up to 4 load cells in parallel
		Ex interface, type SIWAREX Pi 7MH4 710-5AA With UL and FM approvals, but without ATEX approval , for intrinsically-safe connection of load cells, suitable for the SIWAREX U, M, FTA, FTC, CS and P weighing modules. Use in the EC is not possible.
		Manual for Ex interface type SIWAREX Pi C71000-T5974-C29
		SIWAREX IS Ex interface With ATEX approval, but without UL and FM approvals , for intrinsically-safe connection of load cells, including Manual, suitable for the SIWAREX U, M, FTA, FTC, CS and P weighing modules. Use in the EC is possible. <ul style="list-style-type: none"> With short-circuit current < 199 mA DC 7MH4 710-5BA With short-circuit current < 137 mA DC 7MH4 710-5CA Cable (optional)

A) Subject to export regulations: AL: N and ECCN: EAR99H

SIMATIC S7-300

Function modules

SIWAREX U

Ordering data (continued)	Order No.	Ordering data (continued)	Order No.
<p>Cable Li2Y 1 x 2 x 0.75 ST + 2 x (2 x 0.34 ST) - CY, orange sheath to connect SIWAREX U, M, P, FTA, FTC, CS, MS and CF to the junction box (JB), extension box (EB) or Ex interface (Ex-I) or between two JB's, for fixed laying, occasional bending is possible, 10.8 mm outer diameter, for ambient temperature -40 to +80 °C</p>	7MH4 702-8AG	<p>Cable Li2Y 1 x 2 x 0.75 ST + 2 x (2 x 0.34 ST) - CY, blue sheath to connect the junction box (JB) or extension box (EB) in a potentially explosive atmosphere to the Ex interface (Ex-I), for fixed laying, occasional bending is possible, blue PVC insulating sheath, approx. 10.8 mm outer diameter, for ambient temperature -40 to +80 °C</p>	7MH4 702-8AF
		<p>Cable LiYCY 4 x 2 x 0.25 mm² ^{A)} for TTY (connect 2 pairs of conductors in parallel), for connection of a remote indicator</p>	7MH4 407-8BD0

A) Subject to export regulations: AL: N and ECCN: EAR99H

4

SIMATIC S7-300

Function modules

SIWAREX FTA

www.DataSheet4U.com

Overview



SIWAREX FTA weighing module

The SIWAREX FTA (Flexible Technology, Automatic Weighing Instrument) is a versatile and flexible weighing module for industrial use. It can be used for automatic and non-automatic weighing, e.g. for the production of mixtures, filling, loading, monitoring and bagging.

It has been assigned appropriate scale approvals and is also suitable for calibration plants.

The SIWAREX FTA function module is integrated in SIMATIC S7/PCS7, and uses the features of this modern automation system, such as integral communication, diagnostics and configuration tools.

Technical specifications

SIWAREX FTA	
Use in automation systems	
• S7-300	Directly or via ET 200M
• S7-400 (H)	Via ET 200M
• PCS 7 (H)	Via ET 200M
Communication interfaces	
SIMATIC S7, RS 232, RS 485	
Module parameterization	
Using SIMATIC S7	
Using SIWATOOL FTA software (RS 232)	
Measuring properties	
• EC type approval as non-automatic weighing machine, trade class III	3 x 6000 d ≥ 0.5 μV/e
• Internal resolution	16 million parts
• Internal/external updating rate	400/100 Hz
Several parameterizable digital filters	
Critically damped, Bessel, Butterworth (0.05 ... 20 Hz), mean value filter	
Weighing functions	
• Non-automatic weighing machine	OIML R76
• Automatic weighing machine	OIML R51, R61, R107
Load cells	
Strain gauges in 4-wire or 6-wire system	
• 3 characteristic value ranges	1, 2 or 4 mV/V
Load cell powering	
• Supply voltage U_S (rated value)	10.3 V DC
• Max. supply current	184 mA
• Permissible load cell resistance	> 56 Ω > 87 Ω with Ex interface ≤ 4010 Ω
- R_{Lmin}	
- R_{Lmax}	

Max. distance of load cells	
When using the recommended cable:	
• Standard	1000 m (500 m legal-for-trade)
• In hazardous area ¹⁾	
- For gases of group IIC	300 m
- For gases of group IIB	1000 m
Connection to load cells in Ex zone 1	
Optionally via SIWAREX IS Ex interface	
Ex approvals zone 2 and safety	
ATEX 100a, FM, UL, cUL _{US} Haz. Loc.	
Power supply	
• Rated voltage	24 V DC
• Max. current consumption	500 mA
• Current consumption from backplane bus	Typ. 55 mA
Inputs/outputs	
• Digital inputs	7 DI electrically isolated
• Digital outputs	8 DO electrically isolated
• Counter input	Up to 10 kHz
• Analog output	
- Current range	0/4 to 20 mA
- Updating rate	100 Hz
Approvals	
EC type approval (CE, OIML R76) OIML R51, R61, R107	
Degree of protection to DIN EN 60529; IEC 60529	
IP20	
Climatic requirements	
$(T_{min} (IND) \dots T_{max} (IND))$ (operating temperature)	
• Vertical installation	-10 ... 60 °C
• Horizontal installation	-10 ... 40 °C
EMC requirements	
EN 61326, EN 45501, NAMUR NE21, Part 1	
Dimensions in mm	
80 x 125 x 130	
Weight	
600 g	

1) For details, refer to SIWAREX IS data sheet

SIMATIC S7-300

Function modules

SIWAREX FTA

4

Ordering data	Order No.	Order No.	
<p>SIWAREX FTA Legal-for-trade weighing electronics for automatic scales for S7-300 and ET 200M. EC type approval 3 x 6000 d Applications: dosing, filling, bagging, loading. Note: observe approval conditions for applications with obligation of verification. It is recommendable to use the calibration set and contact the SIWAREX hotline.</p>	7MH4 900-2AA01	<p>SIWAREX Multiscale STEP 7 software for SIWAREX FTA. Control of one or more scales for a scalable number of components and any number of recipes. Applications: batching plants, mixers in production process, CD-ROM</p>	7MH4 900-2AL01
<p>SIWAREX FTA Manual</p> <ul style="list-style-type: none"> • German • English • Italian • Spanish • French <p>Free download from the Internet at: www.siemens.com/weighing-technology</p>		<p>SIWAREX Multifill STEP 7 software for SIWAREX FTA. Control of filling and bagging processes for one or more filling stations and any number of materials, CD-ROM</p>	7MH4 900-2AM01
<p>SIWAREX FTA "Getting started" Example software for easy acquaintance with scale programming in STEP 7. Free download from the Internet at: www.siemens.com/weighing-technology</p>		<p>SIWATOOL cable from SIWAREX FTA with serial PC interface, for 9-pin PC interfaces (RS 232)</p> <ul style="list-style-type: none"> • 2 m long • 5 m long 	<p>7MH4 702-8CA 7MH4 702-8CB</p>
<p>SIWAREX FTA configuration package for SIMATIC S7 on CD-ROM</p> <ul style="list-style-type: none"> • SETUP for S7 link with STEP 7 V5.2 or later • S7 function block • SIWATOOL FTA commissioning software • Manual 	7MH4 900-2AK01	<p>40-pin front plug with screw contacts (required for each SIWAREX module), alternatively with spring-loaded contacts</p>	6ES7 392-1AM00-0AA0
<p>SIWAREX FTA configuration package for PCS 7 V6.x on CD-ROM</p> <ul style="list-style-type: none"> • SETUP for S7 link • Function block for CFC • Faceplate • SIWATOOL FTA commissioning software • Manual 	7MH4 900-2AK61	<p>40-pin front plug with spring-loaded contacts (required for each SIWAREX module), alternatively with screw contacts</p>	6ES7 392-1BM00-0AA0
<p>SIWAREX FTA configuration package for PCS 7 V5.1 and V5.2 On request</p>	on request	<p>Shield contact element Sufficient for one SIWAREX FTA module</p>	6ES7 390-5AA00-0AA0
<p>Calibration set for SIWAREX FTA For verification of up to 5 scales comprising:</p> <ul style="list-style-type: none"> • 1x inscription foil for labeling • 1x protection foil • 10x EC verification marks (black M on green background) • Guidelines for verification, verification certificates and approvals, adaptable label • SIWAREX FTA Manual 	7MH4 900-2AY10	<p>Shield connection terminal Contents: 2 units (suitable for cable with diameter 4 ... 13 mm) Note: one shield connection terminal is required each for:</p> <ul style="list-style-type: none"> • Scale connection • RS 485 interface • RS 232 interface 	6ES7 390-5CA00-0AA0
		<p>S7 DIN rail</p> <ul style="list-style-type: none"> • 160 mm • 480 mm • 530 mm • 830 mm • 2000 mm 	<p>6ES7 390-1AB60-0AA0 6ES7 390-1AE80-0AA0 6ES7 390-1AF30-0AA0 6ES7 390-1AJ30-0AA0 6ES7 390-1BC00-0AA0</p>
		<p>PS 307 load power supply (only required if DC 24 V is not available) 120/230 V AC; 24 V DC</p> <ul style="list-style-type: none"> • PS 307-1B; 2 A • PS 307-1E; 5 A • PS 307-1K; 10 A 	<p>6ES7 307-1BA00-0AA0 6ES7 307-1EA00-0AA0 6ES7 307-1KA00-0AA0</p>
		<p>MMC memory for data recording up to 16 MB</p>	6ES7 953-8LF11-0AA0

SIMATIC S7-300

Function modules

SIWAREX FTA

Ordering data (continued)

Remote display (option)

The Siebert S102 and S302 remote digital display can be directly connected to the SIWAREX FTA via an RS 485 interface.

Siebert Industrieelektronik GmbH
P.O. Box 1180
D-66565 Eppelborn
Tel.: +49 6806/980-0
Fax: +49 6806/980-999
Internet: <http://www.siebert.de>

Detailed information available from manufacturer.

SIWAREX JB junction box, aluminium housing

7MH4 710-1BA

for connecting up to 4 load cells in parallel, and for connecting several junction boxes

SIWAREX JB junction box, stainless steel housing

7MH4 710-1EA

for connecting up to 4 load cells in parallel

Ex interface, type SIWAREX Pi

7MH4 710-5AA

With UL and FM approvals, but **without ATEX approval** for intrinsically-safe connection of load cells, suitable for the SIWAREX U, M, FTA, FTC, CS and P weighing modules.
Use in the EC is not possible.

Manual for Ex interface type SIWAREX Pi

C71000-T5974-C29

Ex interface, type SIWAREX IS

With ATEX approval, but **without UL and FM approvals** for intrinsically-safe connection of load cells, including Manual, suitable for the SIWAREX U, M, FTA, FTC, CS and P weighing modules.
Use in the EC is possible.

- With short-circuit current < 199 mA DC
- With short-circuit current < 137 mA DC

7MH4 710-5BA

7MH4 710-5CA

Cable (optional)

Cable Li2Y 1 x 2 x 0.75 ST + 2 x (2 x 0.34 ST) - CY, orange sheath

7MH4 702-8AG

to connect SIWAREX U, M, P, FTA, FTC, CS, MS and CF to the junction box (JB), extension box (EB) or Ex interface (Ex-I) or between two JB's, for fixed laying, occasional bending is possible, 10.8 mm outer diameter, for ambient temperature -40 to +80 °C

Cable Li2Y 1 x 2 x 0.75 ST + 2 x (2 x 0.34 ST) - CY, blue sheath

7MH4 702-8AF

to connect the junction box (JB) or extension box (EB) in a potentially explosive atmosphere to the Ex interface (Ex-I), for fixed laying, occasional bending is possible, blue PVC insulating sheath, approx. 10.8 mm outer diameter, for ambient temperature -40 to +80 °C

Cable LiYCY 4 x 2 x 0.25 mm² A) 7MH4 407-8BD0

for TTY (connect 2 pairs of conductors in parallel), for connection of a remote indicator

A) Subject to export regulations: AL: N and ECCN: EAR99H

www.DataSheet4U.com
Overview

SIWAREX FTC weigh module

The SIWAREX FTC (Flexible Technology for Continuous Weighing) is a versatile and flexible weigh module for conveyor scales, differential proportioning weighers and bulk flow meters. It can also be used to record weights and measure force. The SIWAREX FTC function module is integrated in SIMATIC S7/PCS7, and uses the features of this modern automation system, such as integral communication, diagnostics and configuration tools.

Technical specifications

SIWAREX FTC	
Use in automation systems	
• S7-300	Directly or via ET 200M
• S7-400 (H)	Via ET 200M
• PCS 7 (H)	Via ET 200M
Communications interfaces	SIMATIC S7, RS 232, RS 485
Module parameterization	Using SIMATIC S7
	Using SIWATOOL FTC software (RS 232)
Measuring properties	
• EC type approval as non-automatic weighing machine, trade class III	3 x 6000 d ≥ 0.5 μV/e
• Internal resolution	+/- 8 million parts
• Internal/external updating rate	400/100 Hz
Several parameterizable digital filters	Critically damped, Bessel, Butterworth (0.05 ... 20 Hz), mean value filter
Weighing functions	
• Non-automatic weighing machine, force measurement	
• Conveyor scale	
Load cells	Strain gages in 4-wire or 6-wire system
• 3 characteristic value ranges	1, 2 or 4 mV/V
Load cell powering	
• Supply voltage U_S (rated value)	10.3 V DC
• Max. supply current	184 mA
• Permissible load cell resistance	
- R_{Lmin}	> 56 Ω > 87 Ω with Ex interface
- R_{Lmax}	≤ 4010 Ω

Max. distance of load cells	
When using the recommended cable:	
• Standard	1000 m (500 m legal-for-trade)
• In hazardous area ¹⁾	
- For gases of group IIC	300 m
- For gases of group IIB	1000 m
Connection to load cells in Ex zone 1	Optionally via SIWAREX IS Ex interface
Ex approvals zone 2 and safety	ATEX 100a, FM, UL, cUL _{US} Haz. Loc. (all available soon)
Power supply	
• Rated voltage	24 V DC
• Max. current consumption	500 mA
• Current consumption from backplane bus	Typ. 55 mA
Inputs/outputs	
• Digital inputs	7 DI electrically isolated
• Digital outputs	8 DO electrically isolated
• Counter input	Up to 10 kHz
• Analog output	
- Current range	0/4 to 20 mA
- Updating rate	100 Hz
Approvals	
For NAWI mode	EC type approval, OIML-R76
Degree of protection to DIN EN 60529; IEC 60529	IP20
Climatic requirements	
(T_{min} (IND) ... T_{max} (IND)) (operating temperature)	
• Vertical installation	-10 ... 60 °C
• Horizontal installation	-10 ... 40 °C
EMC requirements	EN 61326, EN 45501, NAMUR NE21, Part 1
Dimensions in mm	80 x 125 x 130
Weight	600 g

1) For details, refer to SIWAREX IS data sheet

SIMATIC S7-300

Function modules

SIWAREX FTC

4

Ordering data

Ordering data	Order No.
SIWAREX FTC Weighing electronics for conveyor scales for S7-300 and ET 200M. Applications: Force measurement, conveyor scales	7MH4 900-3AA01
SIWAREX FTC Manual German, English, Italian, Spanish, French Free download from the Internet at: www.siemens.com/weighing-technology	
SIWAREX FTC "Getting started" Example software for easy acquaintance with scale programming in STEP 7. Free download from the Internet at: www.siemens.com/weighing-technology	
SIWAREX FTC configuration package for SIMATIC S7 on CD-ROM <ul style="list-style-type: none"> • SETUP for S7 link with STEP 7 V5.2 • S7 function block • SIWATOOL FTC commissioning software • Manual 	7MH4 900-3AK01
SIWAREX FTC configuration package for PCS 7 V6.x on CD-ROM <ul style="list-style-type: none"> • SETUP for S7 link • Function block for CFC • Faceplate • SIWATOOL FTC commissioning software • Manual 	7MH4 900-3AK61
SIWATOOL cable from SIWAREX FTC with serial PC interface, for 9-pin PC interfaces (RS 232) <ul style="list-style-type: none"> • 2 m long • 5 m long 	7MH4 702-8CA 7MH4 702-8CB
40-pin front plug with screw contacts (required for each SIWAREX module), alternatively with spring-loaded contacts	6ES7 392-1AM00-0AA0
40-pin front plug with spring-loaded contacts (required for each SIWAREX module), alternatively with screw contacts	6ES7 392-1BM00-0AA0
Shield contact element Sufficient for one SIWAREX FTC module	6ES7 390-5AA00-0AA0
Shield connection terminal Contents: 2 units (suitable for cable with diameter 4 ... 13 mm) Note: one shield connection terminal is required each for: <ul style="list-style-type: none"> • Scale connection • RS 485 interface • RS 232 interface 	6ES7 390-5CA00-0AA0

S7 DIN rail

- 160 mm
- 480 mm
- 530 mm
- 830 mm
- 2000 mm

6ES7 390-1AB60-0AA0
6ES7 390-1AE80-0AA0
6ES7 390-1AF30-0AA0
6ES7 390-1AJ30-0AA0
6ES7 390-1BC00-0AA0

PS 307 load power supply

(only required if DC 24 V is not available)

120/230 V AC; 24 V DC

- PS 307-1B; 2 A
- PS 307-1E; 5 A
- PS 307-1K; 10 A

6ES7 307-1BA00-0AA0
6ES7 307-1EA00-0AA0
6ES7 307-1KA00-0AA0

MMC memory

for data recording up to 16 MB

6ES7 953-8LF11-0AA0

Remote display (option)

The Siebert S102 and S302 remote digital display can be directly connected to the SIWAREX FTC via an RS 485 interface. (not suitable for mode "Conveyor scale")

Siebert Industrieelektronik GmbH
 P.O. Box 1180
 D-66565 Eppelborn
 Tel.: +49 6806/980-0
 Fax: +49 6806/980-999
 Internet: <http://www.siebert.de>

Detailed information available from manufacturer.

SIWAREX JB junction box, aluminium housing

for connecting up to 4 load cells in parallel, and for connecting several junction boxes

7MH4 710-1BA

SIWAREX JB junction box, stainless steel housing

for connecting up to 4 load cells in parallel

7MH4 710-1EA

Ex interface, type SIWAREX Pi

With UL and FM approvals, but **without ATEX approval** for intrinsically-safe connection of load cells, suitable for the SIWAREX U, M, FTA, FTC, CS and P weighing modules. Use in the EC is not possible.

7MH4 710-5AA

Manual for Ex interface type SIWAREX Pi

C71000-T5974-C29

SIWAREX IS Ex interface

With ATEX approval, but **without UL and FM approvals** for intrinsically-safe connection of load cells, including Manual, suitable for the SIWAREX U, M, FTA, FTC, CS and P weighing modules. Use in the EC is possible.

- With short-circuit current < 199 mA DC
- With short-circuit current < 137 mA DC

7MH4 710-5BA

7MH4 710-5CA

Cable (optional)

see SIWAREX U, page 4/183

www.DataSheet4U.com

Overview



SIWAREX M is a legal-for-trade weighing module for exact weighing and proportioning, and can be used in SIMATIC automation systems without problem. The module controls the proportioning of individual setpoints independent of the cycle time of the automation system, and therefore achieves a high proportioning accuracy.

4

Technical specifications

SIWAREX M	
Main applications	<ul style="list-style-type: none"> • Platform scales • Fill level (containers/bins) • Proportioning and batching scales • Scales with verification capability
Intrinsically-safe load cell powering	Optional (Ex-I)
Stand-alone (without SIMATIC)	Yes
Integration in:	
• S5-90/-95U/-100U	Via RS 232/TTY + CP
• S5-95U/DP (PROFIBUS master)	Via RS 232/TTY + CP
• S5-115U/-135U/-155U	Via ET 200M
• S7-300	Direct integration
• S7-400	Via ET 200M
• PCS 7	Via ET 200M
• C7	Via IM or ET 200M
• TELEPERM M (AS 388/488/TM)	Via ET 200M
Communication interfaces	SIMATIC S7 (P bus) RS 232, TTY
Process interfaces	
• Digital inputs	3 (assignable)
• Digital outputs	4 (assignable)
• Analog output/analog input	Yes / No
Remote display connection (via serial interface)	Yes (verification capability) Gross/net/setpoint Remote display with operator control
Printer connection	Yes (verification capability)
Measuring properties	
EU type approval for medium accuracy weighing machines Class III (with verification capability)	6000 d
Error limit according to DIN 1319-1 of full-scale value at 20 °C ± 10 K	0,01 %
n_{ind} in acc. with EN 45 501	6000
Min. measuring signal Δu_{min} per d	0.5 μ V
Internal resolution	± 524.288
Data format for weight values	4 byte (fixed-point)

SIWAREX M	
Number of measurements/second	50
Filter	Exponent filter: 0.05 ... 5 Hz Mean value filter
Weighing functions	
• Weight values	Gross/net/tare
• Limits	4 (min./max./empty/overflow)
• Scale standstill	Yes
• Zero setting function	Via command or automatically
Proportioning functions	<ul style="list-style-type: none"> • Control of coarse/fine flow valves • Tolerance monitoring • Material flow monitoring • Autom. proportioning optimization • Autom. reproportioning • Inching mode
Module parameterization	Via SIMATIC S5/S7/C7 or SIWATOOL M PC parameterization software
UL/CSA/FM certification	Yes
IP degree of protection to DIN EN 60529; IEC 60529	In S7 frame: IP20 Stand-alone: IP10
Load cell powering	
• Supply voltage U_s (rated value)	10.2 V DC
• Max. supply current	≤ 180 mA
• Permissible load resistance:	
- R_{Lmin}	> 60 Ω
- R_{Lmax}	< 4010 Ω
	<u>With Ex(i) interface:</u>
- R_{Lmin}	> 87 Ω
- R_{Lmax}	< 4010 Ω
Permissible load cell characteristic	Up to 4 mV/V
Permissible range of measuring signal (at greatest set characteristic)	-41.5 ... 41.5 mV DC
Max. distance of load cells	1000 m (300 m in Ex area ¹⁾)

1) Up to 1000 m, depending on the gas group. www.DataSheet4U.com

SIMATIC S7-300

Function modules

SIWAREX M

Technical specifications (continued)

SIWAREX M	
Supply voltage 24 V DC	
• Rated voltage	24 V DC
• Max. current consumption	300 mA
Voltage supply from backplane bus	typ. 50 mA
Serial port 1	
	RS 232:
• Baud rate	2400/9600 baud
• Parity	Even/odd
• No. of data bits/stop bits	8/1
• Signal level	In acc. with EIA-RS 232
• Protocols	SIWAREX protocol 3964R XON/XOFF (printer) ²⁾
Serial port 2	
	TTY:
• Baud rate	9600 baud
• Parity	straight
• No. of data bits/stop bits	8/1
• Signal level	Active/passive (floating)
• Protocols	Remote display protocol SIWAREX protocol 3964R

SIWAREX M	
Binary inputs	
	Number: 3
	Rated voltage: 24 V
	Switching frequency: 10 Hz
Binary outputs	
	Number: 4 (digital)
	Rated voltage: 24 V
	Rated current: 0.5 A
	Total max.: 1 A
	Electrical isolation: 500 V
Analog output	
• Output range	0/4 ... 20 mA
• Total error at 25 °C	0.15 %
• Updating rate	Approx. 350 ms
• Resolution	16 bits (0 ... 20 mA)
• Burden including line resistance	≤ 600 Ω
Climatic requirements	
Tmin(IND) ... Tmax(IND) (operating temperature)	
• Vertical installation	-10 ... +60 °C
• Horizontal installation/ with verification capability	-10 ... +40 °C
MTBF (SN 29500)	172,000 h at +40 °C

2) Serial printer, ANSI-, EPSON-, IBM-compatible

Ordering data

Order No.	Order No.
SIWAREX M Medium accuracy weighing machine Class III, 6000 d, for the SIMATIC S7 and ET 200M, incl. bus connector, weight 0.6 kg Note: In the case of applications with obligation of verification, observe the conditions for approval! It is recommended to contact the SIWAREX hotline.	7MH4 553-1AA41
SIWAREX M Manual • German, English Free download on the Internet at: www.siemens.com/weighing-technology	
SIWAREX M configuration package for SIMATIC S5/S7 version 5.1 or higher in German and English on CD-ROM • SIWATOOL PC parameterization software • SIMATIC S7 function blocks • SIMATIC S5 function blocks • SIWAREX M Manual on CD • Setup for incorporation of SIWAREX M into STEP 7	7MH4 583-3FA63
SIWAREX M configuration package for PCS 7, version 5.2 in German and English on CD-ROM Block for the CFC and faceplate	7MH4 583-3EA63

Order No.	Order No.
SIWAREX M configuration package for PCS 7, version 6.x in German and English on CD-ROM Block for the CFC and faceplate	7MH4 583-3EA64
SIWAREX Batch Recipe control for proportioning processes with SIWAREX M modules • STEP 7 program for SIMATIC S7 (CPU 314 or better) • Example programs for GUI for OP7 and OP27 (configuration with ProTool) • Documentation in German and English	7MH4 553-4GS01
SIWAREX Batch secondary license Connection of SIWAREX M to serial PC interface • for 9-pin PC interface, 2 m long • for 9-pin PC interface, 5 m long	7MH4 583-4KL01 7MH4 702-8CA 7MH4 702-8CB
Installation material (mandatory)	
Front connector for SIWAREX M 20-pin, with screw contacts (required for each SIWAREX module)	6ES7 392-1AJ00-0AA0

SIMATIC S7-300

Function modules

SIWAREX M

4

Ordering data (continued)	Order No.	Order No.
Shield contact element A shield contact element is sufficient for one SIWAREX M module	6ES7 390-5AA00-0AA0	
Shield connection terminal Contents: 2 units (suitable for 1 cable with diameter 4 to 13 mm) Note: one shield connection terminal is required each for the <ul style="list-style-type: none"> • Scale connection • TTY interface • RS 232 interface • Analog output • Digital inputs/outputs 	6ES7 390-5CA00-0AA0	
S7 DIN rail <ul style="list-style-type: none"> • 160 mm • 480 mm • 530 mm • 830 mm • 2000 mm 	6ES7 390-1AB60-0AA0 6ES7 390-1AE80-0AA0 6ES7 390-1AF30-0AA0 6ES7 390-1AJ30-0AA0 6ES7 390-1BC00-0AA0	
Accessories (optional)		
PS 307 load power supplies 120/230 V AC; 24 V DC, incl. power connector PS 307-1B; 2 A PS 307-1E; 5 A PS 307-1K; 10 A	6ES7 307-1BA00-0AA0 6ES7 307-1EA00-0AA0 6ES7 307-1KA00-0AA0	
Labeling strips (10 units, spare part) Cables and connectors (optional)	6ES7 392-2XX00-0AA0	
Sub-D connector, 9-pin (female) Quantity: 1 unit, for PC interface (RS 232)	6ES5 750-2AB11	
Sub-D connector, 9-pin (male) Quantity: 1 unit, for RS 232 interface of SIWAREX M	6ES5 750-2AA11	
Sub-D connector, 15-pin (male) Quantity: 1 unit, for TTY interface of SIWAREX M	6ES5 750-2AA21	
Sub-D connector, 25-pin (male) <ul style="list-style-type: none"> • Quantity: 1 unit, for printer interface (RS 232) 	6ES5 750-2AA31	
Sub-D connector, 25-pin (female) <ul style="list-style-type: none"> • Quantity: 1 unit, for PC interface (RS 232) 	6ES5 750-2AB31	
		Remote displays (option) Remote displays The digital remote displays can be connected directly to SIWAREX M through a TTY interface. The following remote displays can be used: S102 and S302 Siebert Industrieelektronik GmbH P.O. Box 1180 D-66565 Eppelborn Tel.: +49 6806/980-0 Fax: +49 6806/980-999 Internet: http://www.siebert.de Detailed information available from manufacturer.
		Accessories for remote displays Legal-for-trade memory The OmniScale legal-for-trade memory can be connected to the SIWAREX M instead of the printer. There are 2 device versions: <ul style="list-style-type: none"> • for mounting rails <ul style="list-style-type: none"> - Horizontal, part number 522 201 - Vertical, part number 522 202 CSM GmbH Raiffeisenstr. 34 D-70794 Filderstadt Tel.: +49 711/77964-20 Fax: +49 711/77964-40 Internet: http://www.csm.de Detailed information available from manufacturer.
		Printers (optional) T 2240/24 printer
		6GF6 520-1LM Needle matrix printer, 24 needles, DIN A4 and continuous form Note An RS 232 interface must be ordered in addition.
		RS 232 interface for T 2240/24
		6GF6 520-2HA See Catalog KT61 for further printers
		Printer accessories Connection of SIWAREX M to serial printer interface (RS 232, 25-pin)
		7MH4 702-8CH 7MH4 702-8CK <ul style="list-style-type: none"> • 5 m long • 10 m long
		Accessories for SIWAREX M SIWAREX JB junction box, aluminium housing
		7MH4 710-1BA for connecting up to 4 load cells in parallel, and for connecting several junction boxes
		SIWAREX JB junction box, stainless steel housing
		7MH4 710-1EA for connecting up to 4 load cells in parallel

SIMATIC S7-300

Function modules

SIWAREX M

Ordering data (continued)

Ex interface, type SIWAREX Pi

With UL and FM approvals, but **without ATEX approval**, for intrinsically-safe connection of load cells, suitable for the SIWAREX U, M, FTA, FTC, CS and P weighing modules.
Use in the EC is not possible.

Order No.

7MH4 710-5AA

Manual for Ex interface type SIWAREX Pi

C71000-T5974-C29

SIWAREX IS Ex interface

With ATEX approval, but **without UL and FM approvals**, for intrinsically-safe connection of load cells, including Manual, suitable for the SIWAREX U, M, FTA, FTC, CS and P weighing modules.
Use in the EC is possible.

- With short-circuit current < 199 mA DC
- With short-circuit current < 137 mA DC

7MH4 710-5BA

7MH4 710-5CA

Cable (optional)

Cable Li2Y 1 x 2 x 0.75 ST + 2 x (2 x 0.34 ST) - CY, orange sheath

to connect SIWAREX U, M, P, FTA, FTC, CS, MS and CF to the junction box (JB), extension box (EB) or Ex interface (Ex-I) or between two JB's, for fixed laying, occasional bending is possible, 10.8 mm outer diameter, for ambient temperature -40 to +80 °C

7MH4 702-8AG

Cable Li2Y 1 x 2 x 0.75 ST + 2 x (2 x 0.34 ST) - CY, blue sheath

to connect the junction box (JB) or extension box (EB) in a potentially explosive atmosphere to the Ex interface (Ex-I), for fixed laying, occasional bending is possible, blue PVC insulating sheath, approx. 10.8 mm outer diameter, for ambient temperature -40 to +80 °C

7MH4 702-8AF

Cable LiYCY 4 x 2 x 0.25 mm² ^{A)}

for TTY (connect 2 pairs of conductors in parallel), for connection of a remote indicator

7MH4 407-8BD0

A) Subject to export regulations: AL: N and ECCN: EAR99H

www.DataSheet4U.com
Overview

SIWAREX P weighing electronics

SIWAREX P is a weighing and force measuring system for simple tasks. It can be used for all kinds of industrial measurements. SIWAREX P has the design of the SIMATIC S5-100U programmable controllers and can be used as a stand-alone device or also integrated directly in a SIMATIC S5-90U, -95U or -100U programmable controller.

Note:

Bus module available as spare part.

Technical specifications

SIWAREX P	
Main applications	<ul style="list-style-type: none"> • Load measurement on cranes • Overload protection • Belt tensioning devices • Platform scales • Fill level (containers/bins)
Intrinsically-safe load cell powering	Optional (Ex-I)
Stand-alone (without SIMATIC)	Yes
Integration in:	
• S5-90/-95U/-100U	Direct integration
• S5-95U/DP (PROFIBUS master)	Through ET 200U
• S5-115U/-135U/-155U	Through ET 200U
• S7-300	Through ET 200U
• S7-400	Through ET 200U
• M7-300	Through ET 200U
• M7-400	Through ET 200U
• C7	Through ET 200U
Communication interfaces	SIMATIC S5 bus TTY
Process interfaces	
• Digital outputs	2 limits/fault
• Analog output/analog input	Yes / No
Remote display connection (via serial interface)	Yes Gross
Measuring properties	
Error limit according to DIN 1319-1 of full-scale value at 20 °C ± 10 K	0.1 %
Internal resolution	20.000
Data format for weight values	2 byte (fixed-point)
Number of measurements/second	10
Filter	0.0625 -2 Hz
Weighing functions	
• Weight values	Gross
• Limits	2 (min./max.)

SIWAREX P	
Integral display and operator panel	Yes
Module parameterization	Built-in LCD + Membrane keyboard
IP degree of protection to DIN 60 529; IEC 60 529	IP20
Load cell powering	
• Supply voltage U_s (rated value)	10 V ± 0.5 V DC
• Max. supply current	≤ 160 mA or ≤ 115 mA (Ex area)
• Permissible load resistance:	
- R_{Lmin}	> 60 Ω
- R_{Lmax}	< 4010 Ω
	<u>With Ex(i) interface:</u>
- R_{Lmin}	> 87 Ω
- R_{Lmax}	< 4010 Ω
Permissible load cell characteristic	Up to 3 mV/V
Permissible range of measuring signal (at greatest set characteristic)	0 to 33 mV
Max. distance of load cells	500 m (300 m in Ex area)
Supply voltage 24 V DC	
• Rated voltage	24 V DC
• Max. current consumption	300 mA
Serial port 1	TTY (serial 20 mA):
• Baud rate	9600 baud
• Parity	straight
• No. of data bits/stop bits	8/1
• Signal level	Passive, floating
• Protocols	3964R / RK512 (send only on request)
Binary outputs	Number: 2 (relay) Max. switching voltage: 120 V DC 50 V AC Max. current: 1 A (resistive load)

SIMATIC S7-300

Function modules

SIWAREX P

Technical specifications (continued)

SIWAREX P	
Analog output	
• Output range	0/4 ... 20 mA
• Total error at 25°C	0.45 %
• Updating rate	100 ms
• Resolution	10 bits (0 ... 20 mA)
• Burden including line resistance	≤ 500 Ω

SIWAREX P	
Climatic requirements	0 ... +55 °C
Tmin(IND) to Tmax(IND) (operating temperature)	in wall housing: 0 ... +45 °C
EMC requirements according to	EN 50081-2 EN 50082-2

Ordering data

Ordering data	Order No.
SIWAREX P	
• For stand-alone operation without SIMATIC	7MH4 205-1AB01
• For operation within a SIMATIC S5-90U/-95U/-100U and ET 200U programmable controller	7MH4 205-1AC01
SIWAREX P Manual	
• German, English Free download on the Internet at: www.siemens.com/weighing-technology	
Data handling block for communication between the SIWAREX P weighing and force measuring system and a SIMATIC S5-90U/-95U/-100U programmable controller, including description in German and English	7MH4 811-5AP41
Bus module Terminal block for screw connection (required for each SIWAREX P)	6ES5 700-8MA11
SITOP SMART 60W power supply for 115/230 V AC, 24 V DC; 2 A	6EP1 332-2BA10
Wall housing for max. two SIWAREX P weighing and force measuring systems and one PS931 power supply module	7MH4 215-8AA
S102 remote display The digital remote display can be connected directly to the SIWAREX P through the TTY interface. The following remote displays can be connected: S102-05/25/0R-000/0B-TM Siebert Industrieelektronik GmbH P.O. Box 1180 D-66565 Eppelborn Tel.: +49 6806/980-0 Fax: +49 6806/980-999 Internet: http://www.siebert.de Detailed information available from manufacturer.	
Accessories	
SIWAREX JB junction box, aluminium housing for connecting up to 4 load cells in parallel, and for connecting several junction boxes	7MH4 710-1BA

Ordering data	Order No.
SIWAREX JB junction box, stainless steel housing for connecting up to 4 load cells in parallel	7MH4 710-1EA
Ex interface, type SIWAREX Pi With UL and FM approvals, but without ATEX approval , for intrinsically-safe connection of load cells, suitable for the SIWAREX U, M, FTA, FTC, CS and P weighing modules. Use in the EC is not possible.	7MH4 710-5AA
Manual for Ex interface type SIWAREX Pi	C71000-T5974-C29
SIWAREX IS Ex interface With ATEX approval, but without UL and FM approvals , for intrinsically-safe connection of load cells, including Manual, suitable for the SIWAREX U, M, FTA, FTC, CS and P weighing modules. Use in the EC is possible.	
• With short-circuit current < 199 mA DC	7MH4 710-5BA
• With short-circuit current < 137 mA DC	7MH4 710-5CA
Cable (optional)	
Cable Li2Y 1 x 2 x 0.75 ST + 2 x (2 x 0.34 ST) - CY, orange sheath to connect SIWAREX U, M, P, FTA, FTC, CS, MS and CF to the junction box (JB), extension box (EB) or Ex interface (Ex-I) or between two JB's, for fixed laying, occasional bending is possible, 10.8 mm outer diameter, for ambient temperature -40 to +80 °C	7MH4 702-8AG
Cable Li2Y 1 x 2 x 0.75 ST + 2 x (2 x 0.34 ST) - CY, blue sheath to connect the junction box (JB) or extension box (EB) in a potentially explosive atmosphere to the Ex interface (Ex-I), for fixed laying, occasional bending is possible, blue PVC insulating sheath, approx. 10.8 mm outer diameter, for ambient temperature -40 to +80 °C	7MH4 702-8AF
Cable LiYCY 4 x 2 x 0.25 mm² A) for TTY (connect 2 pairs of conductors in parallel), for connection of a remote indicator	7MH4 407-8BD0

A) Subject to export regulations: AL: N and ECCN: EAR99H

SIMATIC S7-300

Function modules

Radio clock module SIPLUS DCF 77

www.DataSheet4U.com
Overview



The synchronisation of the real-time clock for the automation systems SIMATIC S7-200, S7-300 and S7-400 with the official time of day of the time signal transmitter DCF 77 of the Physikalisch-Technische Bundesanstalt Braunschweig is made by this module.

The time receipt occurs via a DCF transmitter (antenna with solid-state) which is connected to the the SIMATIC and SIPLUS PLC via two digital inputs and a software driver included in the scope of supply (function block FB).

The function blocks can be downloaded under:
<http://www.siemens.com/siplus> - Support - Tools & Downloads!

4

Technical specifications

Radio clock module SIPLUS DCF 77	
Radio frequency	77,5 Hz
Power supply	DC 24 V (DC 20,4 ... 28, 8)
Power consumption, typ.	50 mA
Dimensions (W x H x D)	75 x 125 ¹⁾ x 75

1) Additionally 25 mm (0.98 in) for heavy duty threaded joint and bending radius for cables

Ordering data

Order No.

Radio clock module SIPLUS DCF 77	A) 6AG1 057-1AA03-0AA0
---	-------------------------------

For synchronisation of SIMATIC S7-200, S7-300 and S7-400 with the official time of day of the time signal transmitter DCF 77 of the Physikalisch-Technische Bundesanstalt Braunschweig

A) Subject to export regulations: AL: N and ECCN: EAR99H

SIMATIC S7-300

IQ-Sense modules and sensors

IQ-Sense sensor module

www.DataSheet4U.com

Overview



- Intelligent 8-channel electronics module for S7-300/ET 200M
- For the connection of up to 8 IQ-Sense sensors:
 - Optoelectronic sensors
 - Ultrasound sensors
- With standard function blocks for the various sensor technologies for simplified handling on a SIMATIC S7
- Conventional sensors cannot be operated.

Technical specifications

	6ES7 338-7XF00-0AB0
Voltagages and currents	
Load voltage L+	
• Rated value (DC)	24 V
Current consumption	
from load voltage L+ (without load), max.	1 A
from backplane bus DC 5 V, max.	150 mA; typically
Connection point	
required front connectors	20-pin
Digital inputs	
Number of digital inputs	8
Cable length	
• Cable length unshielded, max.	50 m
Encoder	
Connectable encoders	
• Description	photoelectronic proximity switches and ultrasonic sensors with IQ-Sense, cycle time 2.88 to 6 ms
Status information/ alarms/diagnostics	
Diagnostics indication LED	
• Status indicator digital input (green)	Yes
Isolation	
Isolation checked with	500 V DC
Isolation	
Galvanic isolation, digital inputs	
• between the channels	No
• between the channels and the backplane bus	Yes
Dimensions and weight	
Width	40 mm
Height	125 mm
Depth	120 mm
Weights	
Weight, approx.	250 g

Ordering data

Order No.

8x IQ-Sense sensor module 6ES7 338-7XF00-0AB0

Sensors for connecting to the sensor module

Diffuse sensors

Model C40 IQ-Sense	3SF7 240-3JQ00
Model K80 IQ-Sense	3SF7 210-3JQ00
with background fading, model K80 IQ-Sense	3SF7 214-3JQ00

Diffuse barrier

Model C40 IQ-Sense	3SF7 241-3JQ00
Model K80 IQ-Sense	3SF7 211-3JQ00

Ultrasound sensor

Model M18 IQ-Sense; Range 6-30 cm	3SF6 232-3JA00
Model M18 IQ-Sense; Range 15-100 cm	3SF6 233-3JA00

SIMATIC S7-300

IQ-Sense modules and sensors

Opto proximity switches SIMATIC PXO
with IQ-Sense

www.DataSheet4U.com
Overview



Opto proximity switch with IQ-Sense, C40 design

The photoelectric proximity switches react to changes in the received quantity of light. The light beam emitted from the emitter diode is interrupted or reflected by the object to be detected.

These sensors detect all objects regardless of their composition, whether metal, wood or plastic.

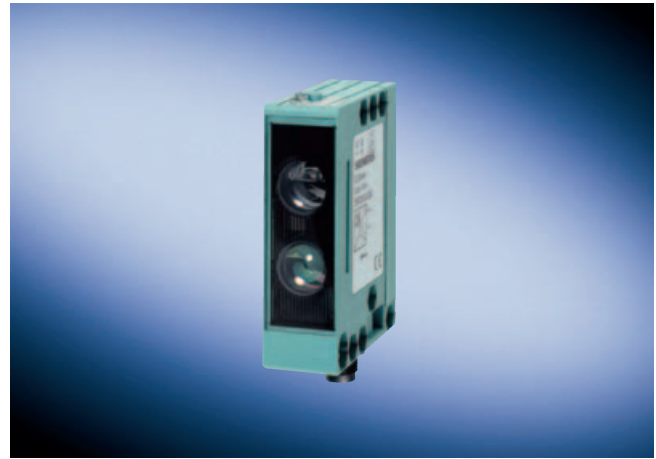

Opto proximity switch with IQ-Sense, K80 design

Depending on the proximity switch type, the interruption or reflection of the light beam is evaluated. The following operating

- Diffuse sensors (energetic)
- Diffuse sensors with background suppression
- Retroreflective sensors.

Features:

- C 40 IQ Sense and K 80 IQ Sense forms
- IntelliTeach functionality
- Integral anti-interference function
- Advanced failure signal (contamination/maladjustment)

Technical specifications

Design	C40 IQ-Sense	K80 IQ-Sense
Diffuse sensor (energetic sensor)		
Sensing range	m 0.7	2
Standard target	mm 200 × 200 (white)	
Emitter (type of light)	nm 660 (red LED)	880 (IR LED)
Current input	mA 50	
Response time	ms 1	
LEDs	Switching display (yellow), surplus light (green)	
Enclosure material	ABS + PBTP	PBTP
Degree of protection	IP67	
Dimensions	mm 40 × 40 × 53	83 × 65 × 25
Diffuse sensor with background suppression		
Sensing range	m –	0.2 ... 1
Standard target	mm –	200 × 200 (white)
Emitter (type of light)	nm –	880 (IR LED)
Current input	mA –	50
Response time	ms –	2
LEDs	–	
Enclosure material	–	
Degree of protection	–	
Dimensions	mm –	83 × 65 × 25

SIMATIC S7-300

IQ-Sense modules and sensors

Opto proximity switches SIMATIC PXO with IQ-Sense

Technical specifications (continued)

Design	C40 IQ-Sense	K80 IQ-Sense
Retroreflective sensor		
Sensing range	m 6	8
Reflector	Type D84, 3RX7916	
Emitter (type of light)	nm 660 (red LED, polarized)	
Current input	mA 50	
Response time	ms 1	
LEDs	Switching display (yellow), surplus light (green)	
Enclosure material	ABS + PBTP	PBTP
Degree of protection	IP67	
Dimensions	mm 40 × 40 × 53	83 × 65 × 25

Selection and ordering data

Version	Design	Type	Order No.
Opto proximity switches for connection to the 4 IQ Sense sensor module	C40 IQ-Sense	Diffuse sensor	3SF7 240-3JQ00
		Retroreflective sensor	3SF7 241-3JQ00
	K80 IQ-Sense	Diffuse sensor	3SF7 210-3JQ00
		Diffuse sensor with background suppression	3SF7 214-3JQ00
		Retroreflective sensor	3SF7 211-3JQ00

Dimension drawings

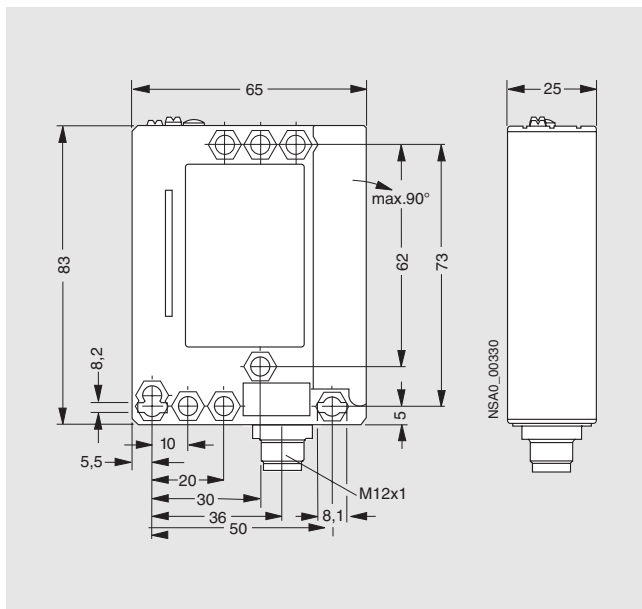

Opto proximity switch with IQ-Sense, K80 design

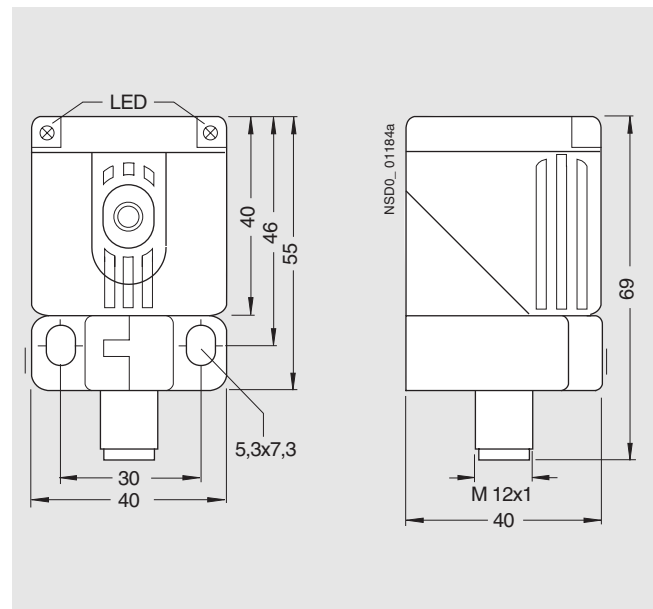

Opto proximity switch with IQ-Sense, C40 design

SIMATIC S7-300

IQ-Sense modules and sensors

Sonar proximity switches SIMATIC PXS
with IQ-Sense

www.DataSheet4U.com

Overview



The communications-capable sonar proximity switches of the M18 IQ compact range are all-in-one units ready for connection, and have a cylindrical M 18 enclosure for connection to the S7-300/ET 200M IQ Sense module SM338, 8×IQ Sense

- 5 operating modes
 - Operation as a measuring sensor ("Analog signal"),
 - Diffuse sensor with background suppression,
 - Diffuse sensor with large differential travel,
 - Diffuse sensor with foreground and background suppression,
 - Retroreflective sensor.
- Static setting of parameters using STEP 7
- Dynamic setting of parameters using an S7 function block
- Measured distance from object is always transmitted
- Synchronization capability, multiplex operation
- Temperature compensation
- Connection through M12 connector
- Non-polarized two-wire system (protected against polarity reversal)
- Channel-specific system diagnostics (e.g. wire break, short-circuit, parameterization faults).

4

Technical specifications

Type		3SF62 32-3JA00	3SF62 33-3JA00
Sensing range			
• Rated value	cm	5 ... 30	15 ... 100
• Maximum value	cm	5 ... 50	15 ... 150
Standard target	mm	10 × 10	20 × 20
Differential travel H (adjustable)	mm	3 ... 30	10 ... 100
Repeat accuracy R	mm	1	2
Operational voltage (DC)		From IQ-Sense	
Rated operating current I_e		From IQ-Sense	
LNo-load supply current I_0		From IQ-Sense	
Adjustment/parameterization		Start and end of the switching range using IQ Sense (IntelliTeach) or local teach-in using potentiometer	

Type		3SF62 32-3JA00	3SF62 33-3JA00
Ultrasonic frequency	kHz	400	200
Switching frequency f	Hz	8	4
Response time	ms	54	110
Measuring time	ms	13.44	26.88
Status display		LED gelb	
Enclosure material		Brass, nickel-plated, CRASTIN converter cover; epoxy resin converter surface	
Degree of protection		IP67	
Ambient temperature			
• Operation	°C	-25 ... +70	
• Storage	°C	-40 ... +85	

Selection and ordering data

Version	Design	Sensing range	Order No.
Sonar proximity switches for connection to IQ Sense	M18 IQ-Sense	5 ... 30 cm	3SF62 32-3JA00
		15 ... 100 cm	3SF62 33-3JA00

SIMATIC S7-300

Special modules

Simulator SM 374

www.DataSheet4U.com

Overview



- Simulator module for testing programs during startup and operation
- For simulation of sensor signals using switches
- For indicating signal statuses at the outputs using LEDs

Technical specifications

	6ES7 374-2XH01-0AA0
Current consumption	
from backplane bus DC 5 V, max.	80 mA
Power loss, typ.	0.35 W
Digital inputs	
Number of digital inputs	16; Switch
Digital outputs	
Number of digital outputs	16; LEDs
Isolation	
Isolation, digital outputs	
• between the channels and the backplane bus	No

	6ES7 374-2XH01-0AA0
Galvanic isolation, digital inputs	
• between the channels and the backplane bus	No
Dimensions and weight	
Width	40 mm
Height	125 mm
Depth	120 mm
Weights	
Weight, approx.	190 g

Ordering data

	Order No.
SM 374 simulator module A)	6ES7 374-2XH01-0AA0
Including bus connector and labeling strip	
Bus connector	6ES7 390-0AA00-0AA0
1 unit (spare part)	
Labeling strip	6ES7 392-2XX00-0AA0
10 units (spare part)	
S7-SmartLabel	2XV9 450-1SL01-0YX0
Software for machine labeling of modules directly from the STEP 7 project	

A) Subject to export regulations: AL: N and ECCN: EAR99H

	Order No.
Labeling sheets for machine labeling	
for 16-channel signal modules, DIN A4, for printing using laser printer; 10 units	
• Petrol	6ES7 392-2AX00-0AA0
• Light beige	6ES7 392-2BX00-0AA0
• Yellow	6ES7 392-2CX00-0AA0
• Red	6ES7 392-2DX00-0AA0
Label cover	6ES7 392-2XY00-0AA0
10 units (spare part)	

www.DataSheet4U.com
Overview

- Dummy module for reserving slots for non-parameterized signal modules
- Structure and address allocation is retained when replaced with a signal module

4

Technical specifications

	6ES7 370-0AA01-0AA0
Current consumption	
from backplane bus DC 5 V, max.	5 mA
Power loss, max.	0.03 W
Dimensions and weight	
Width	40 mm
Height	125 mm
Depth	120 mm
Weights	
Weight, approx.	180 g

Ordering data**Order No.**

DM 370 dummy module	6ES7 370-0AA01-0AA0
Including bus connector and labeling strip	
Bus connector	6ES7 390-0AA00-0AA0
1 unit (spare part)	
Labeling strip	6ES7 392-2XX00-0AA0
10 units (spare part)	
S7-SmartLabel	2XV9 450-1SL01-0YX0
Software for machine labeling of modules directly from the STEP 7 project	
Labeling sheets for machine labeling	
for 16-channel signal modules, DIN A4, for printing using laser printer; 10 units	
Petrol	6ES7 392-2AX00-0AA0
Light beige	6ES7 392-2BX00-0AA0
Yellow	6ES7 392-2CX00-0AA0
Red	6ES7 392-2DX00-0AA0
Label cover	6ES7 392-2XY00-0AA0
10 units (spare part)	

SIMATIC S7-300

Communication

CP 340

www.DataSheet4U.com

Overview

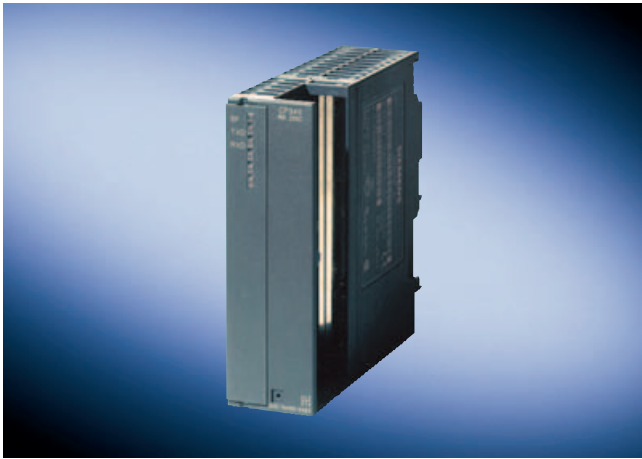

- The economical complete solution for serial communication via point-to-point links.
- 3 versions with different transmission interfaces:
 - RS 232C (V.24)
 - 20 mA (TTY)
 - RS 422/RS 485 (X.27)
- Implemented protocols:
 - ASCII
 - 3964 (R) (not for RS 485)
 - Printer driver
- Simple parameterization via a parameterization tool integrated into STEP 7

Technical specifications

	6ES7 340-1AH02-0AE0	6ES7 340-1BH02-0AE0	6ES7 340-1CH02-0AE0
Supply voltages			
Rated value			
• DC 24 V	No; Power supply via backplane bus 5V	No; Power supply via backplane bus 5V	No; Power supply via backplane bus 5V
Current consumption			
from backplane bus DC 5 V, max.	165 mA	190 mA	165 mA
Power loss, max.	0.85 W	0.95 W	0.85 W
Power loss, typ.	0.6 W	0.85 W	0.6 W
Interfaces			
Number of interfaces	1; electrically isolated	1; electrically isolated	1; electrically isolated
interface physics, 20mA (TTY)		Yes	
interface physics, RS 232C (V.24)	Yes		
interface physics, RS 422/RS 485 (X.27)			Yes
Transmission speed, max.	19.2 kBit/s	19.2 kBit/s	19.2 kBit/s
Transmission speed, min.	2.4 kBit/s	2.4 kBit/s	2.4 kBit/s
Connection point			
PtP	9-pin. D-sub male connector	9-pin D-sub female connector	15-pin D-sub female connector
Voltage supply	over backplane bus	over backplane bus	over backplane bus
Point-to-point			
Cable length, max.	15 m	1,000 m; (100 m active, 1000 m passive)	1,200 m
supported printers	HP-Deskjet, HP-Laserjet, IBM-Proprinter, user-defined	HP-Deskjet, HP-Laserjet, IBM-Proprinter, user-defined	HP-Deskjet, HP-Laserjet, IBM-Proprinter, user-defined
Integrated protocol driver			
• 3964 (R)	Yes	Yes	Yes
• ASCII	Yes	Yes	Yes
• customer-specific drivers reloadable	No	No	No
• RK512	No	No	No
Telegram length, max.			
• 3964 (R)	1,024 Byte	1,024 Byte	1,024 Byte
• ASCII	1,024 Byte	1,024 Byte	1,024 Byte

www.DataSheet4U.com
Technical specifications (continued)

	6ES7 340-1AH02-0AE0	6ES7 340-1BH02-0AE0	6ES7 340-1CH02-0AE0
Transmission speed, 20 mA (TTY) • with 3964 (R) protocol, max. • with ASCII protocol, max. • with printer driver, max.,		19.2 kBit/s 9.6 kBit/s 9.6 kBit/s	
Transmission speed, RS 422/485 • with 3964 (R) protocol, max. • with ASCII protocol, max. • with printer driver, max.			19.2 kBit/s 9.6 kBit/s 9.6 kBit/s
Transmission speed, RS232 • with 3964 (R) protocol, max. • with ASCII protocol, max. • with printer driver, max.,	19.2 kBit/s 9.6 kBit/s 9.6 kBit/s		
Software Block • FB length in RAM, max.	2,700 Byte; Data communication, sending and receiving	2,700 Byte; Data communication, sending and receiving	2,700 Byte; Data communication, sending and receiving
Dimensions and weight			
Width	40 mm	40 mm	40 mm
Height	125 mm	125 mm	125 mm
Depth	120 mm	120 mm	120 mm
Weights			
Weight, approx.	300 g	300 g	300 g

Ordering data**Order No.****Order No.**

CP 340 communications module With one RS 232 C (V.24) interface	6ES7 340-1AH02-0AE0	20 mA (TTY) connecting cable For linking to SIMATIC S7 5 m 10 m 50 m	6ES7 902-2AB00-0AA0 6ES7 902-2AC00-0AA0 6ES7 902-2AG00-0AA0
RS 232 connecting cable For linking to SIMATIC S7 5 m 10 m 15 m	6ES7 902-1AB00-0AA0 6ES7 902-1AC00-0AA0 6ES7 902-1AD00-0AA0	CP 340 communications module With one RS 422/485 (X.27) interface	6ES7 340-1CH02-0AE0
CP 340 communications module With one 20 mA (TTY) interface	6ES7 340-1BH02-0AE0	RS 422/485 connecting cable For linking to SIMATIC S7 5 m 10 m 50 m	6ES7 902-3AB00-0AA0 6ES7 902-3AC00-0AA0 6ES7 902-3AG00-0AA0

SIMATIC S7-300

Communication

SIPLUS CP 340

www.DataSheet4U.com
Overview



- The economical complete solution for serial communications via point-to-point links
- RS 232C (V.24) and RS 422/485 (X.27)
- Implemented protocols:
 - ASCII,
 - 3964 (R) (not for RS 485)
 - Printer driverr
- Simple parameterization by means of a parameterization tool integrated in STEP7

SIPLUS CP 340 version	RS 422/485 (X.27)	RS 232 (V.24)
Order No.	6AG1 340-1CH02-2AE0	6AG1 340-1AH02-2AE0
Order No. based on	6ES7 340-1CH02-0AE0	6ES7 340-1AH02-0AE0
Ambient temperature range	-25 °C to +60 °C, condensation permissible	
Ambient conditions	Suitable for extraordinary medial load (for example by chloric and sulphuric atmospheres).	
Technical data	The technical data are identical with the technical data of the based on modules.	

Ordering data	Order No.
SIPLUS CP 340 communications processor (extended temperature range and medial load) With one RS 232 C (V.24) interface	6AG1 340-1AH02-2AE0
SIPLUS CP 340 communications processor (extended temperature range and medial load) With one RS 422/485 (X.27) interface	6AG1 340-1CH02-2AE0
Accessories	see CP 340, page 4/203

www.DataSheet4U.com
Overview

- For powerful, high-speed serial communication via point-to-point links
- 3 versions with different physical properties:
 - RS 232C (V.24)
 - 20 mA (TTY),
 - RS 422/RS 485 (X.27)
- Implemented protocols: ASCII, 3964 (R), RK 512, customer-specific protocols (reloadable)
- Simple parameterization via a parameterization tool integrated into STEP 7

Technical specifications

	6ES7 341-1AH01-0AE0	6ES7 341-1BH01-0AE0	6ES7 341-1CH01-0AE0
Supply voltages			
Rated value			
• DC 24 V	Yes	Yes	Yes
Current consumption			
from backplane bus DC 5 V, max.	70 mA	70 mA	70 mA
from supply voltage L+, max.	200 mA	200 mA	240 mA
Power loss, max.	4.8 W	4.8 W	5.8 W
interfaces			
Number of interfaces	1; electrically isolated	1; electrically isolated	1; electrically isolated
interface physics, 20mA (TTY)		Yes	
interface physics, RS 232C (V.24)	Yes		
interface physics, RS 422/RS 485 (X.27)			Yes
Transmission speed, max.	76.8 kBit/s	19.2 kBit/s	76.8 kBit/s
Transmission speed, min.	0.3 kBit/s	0.3 kBit/s	0.3 kBit/s
Connection point			
PtP	9-pin Sub-D connector	9-pin Sub-D connector	15-pin sub-D connector
Voltage supply	3 screw terminals: L+, M, GND	3 screw terminals: L+, M, GND	3 screw terminals: L+, M, GND
Point-to-point			
Cable length, max.	15 m	1,000 m	1,200 m
Integrated protocol driver			
• 3964 (R)	Yes	Yes	Yes; not with RS 485
• ASCII	Yes	Yes	Yes
• customer-specific drivers reloadable	Yes	Yes	Yes
• RK512	Yes	Yes	Yes; not with RS 485
Telegram length, max.			
• 3964 (R)	1,024 Byte	1,024 Byte	1,024 Byte
• ASCII	1,024 Byte	1,024 Byte	1,024 Byte
• RK 512	1,024 Byte	1,024 Byte	1,024 Byte

SIMATIC S7-300

Communication

CP 341

Technical specifications (continued)

	6ES7 341-1AH01-0AE0	6ES7 341-1BH01-0AE0	6ES7 341-1CH01-0AE0
Transmission speed, 20 mA (TTY) <ul style="list-style-type: none"> with 3964 (R) protocol, max. with ASCII protocol, max. 		76.8 kBit/s 76.8 kBit/s; 0.3; 0.6; 1.2; 2.4; 4.8; 9.6; 19.2; 38.4; 57.6 and 76.8 kbps (76.8 kbps only achievable with half duplex)	
<ul style="list-style-type: none"> with RK 512 protocol, max. 		76.8 kBit/s	
Transmission speed, RS 422/485 <ul style="list-style-type: none"> with 3964 (R) protocol, max. with ASCII protocol, max. 			76.8 kBit/s 76.8 kBit/s; 0.3; 0.6; 1.2; 2.4; 4.8; 9.6; 19.2; 38.4; 57.6 and 76.8 kbps (76.8 kbps only achievable with half duplex)
<ul style="list-style-type: none"> with RK 512 protocol, max. 			76.8 kBit/s
Transmission speed, RS232 <ul style="list-style-type: none"> with 3964 (R) protocol, max. with ASCII protocol, max. 	76.8 kBit/s 76.8 kBit/s; 0.3; 0.6; 1.2; 2.4; 4.8; 9.6; 19.2; 38.4; 57.6 and 76.8 kbps (76.8 kbps only achievable with half duplex)		
<ul style="list-style-type: none"> with RK 512 protocol, max. 	76.8 kBit/s		
Software			
Block			
<ul style="list-style-type: none"> FB length in RAM, max. 	5,500 Byte; Data communication, sending and receiving	5,500 Byte; Data communication, sending and receiving	5,500 Byte; Data communication, sending and receiving
Dimensions and weight			
Width	40 mm	40 mm	40 mm
Height	125 mm	125 mm	125 mm
Depth	120 mm	120 mm	120 mm
Weights			
Weight, approx.	300 g	300 g	300 g

Ordering data

Order No.	Order No.
CP 341 communications module With one RS 232 C (V.24) interface	6ES7 341-1AH01-0AE0
RS 232 connecting cable For linking to SIMATIC S7	
5 m	6ES7 902-1AB00-0AA0
10 m	6ES7 902-1AC00-0AA0
15 m	6ES7 902-1AD00-0AA0
CP 341 communications module With one 20 mA (TTY) interface	6ES7 341-1BH01-0AE0
20 mA (TTY) connecting cable For linking to SIMATIC S7	
5 m	6ES7 902-2AB00-0AA0
10 m	6ES7 902-2AC00-0AA0
50 m	6ES7 902-2AG00-0AA0
CP 341 communications module With one RS 422/485 (X.27) interface	6ES7 341-1CH01-0AE0
RS 422/485 connecting cable For linking to SIMATIC S7	
5 m	6ES7 902-3AB00-0AA0
10 m	6ES7 902-3AC00-0AA0
50 m	6ES7 902-3AG00-0AA0
Loadable drivers for CP 341 MODBUS master (RTU format)	
<ul style="list-style-type: none"> Single license 	6ES7 870-1AA01-0YA0
<ul style="list-style-type: none"> Single license, without software or documentation 	6ES7 870-1AA01-0YA1
MODBUS slave (RTU format)	
<ul style="list-style-type: none"> Single license 	6ES7 870-1AB01-0YA0
<ul style="list-style-type: none"> Single license, without software or documentation 	6ES7 870-1AB01-0YA1
Data highway (DF1 protocol)	
<ul style="list-style-type: none"> Single license 	6ES7 870-1AE00-0YA0
<ul style="list-style-type: none"> Single license, without software or documentation 	6ES7 870-1AE00-0YA1

www.DataSheet4U.com
Overview

- For powerful, high-speed serial communication via point-to-point links
- 3 versions with different physical properties:
 - RS 232C (V.24)
 - 20 mA (TTY),
- RS 422/RS 485 (X.27)
- Implemented protocols: ASCII, 3964 (R), RK 512, customer-specific protocols (reloadable)
- Simple parameterization via a parameterization tool integrated into STEP 7

4

SIPLUS CP 341 version	RS 422/485 (X.27)
Order No.	6AG1 341-1CH01-2AE0
Order No. based on	6ES7 341-1CH01-0AE0
Ambient temperature range	-25 °C to +60 °C, condensation permissible
Ambient conditions	Suitable for extraordinary medial load (for example by chloric and sulphuric atmospheres).
Technical data	The technical data are identical with the technical data of the based on modules.

Ordering data	Order No.
SIPLUS CP 341 communications module	6AG1 341-1CH01-2AE0
(extended temperature range and medial load)	
With one RS 422/485 (X.27) interface	
Accessories	see CP 341, page 4/206

SIMATIC S7-300

Communication

CP 343-2

Overview

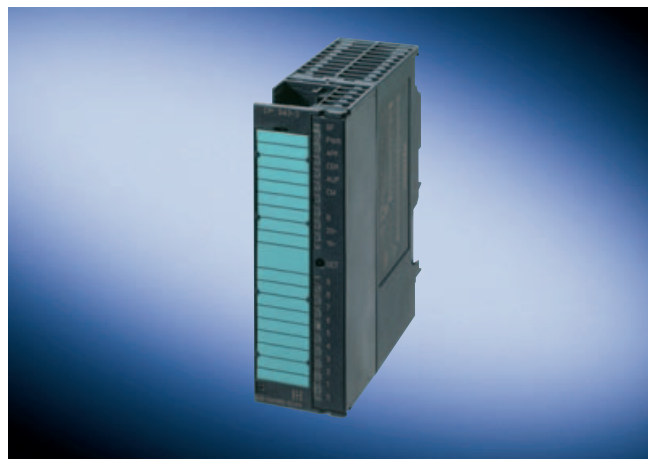

The CP 343-2 is the AS-Interface master for the SIMATIC S7-300 programmable controller and the ET 200 M distributed I/O station. The functions of the communications processor are as follows:

- Up to 62 AS-Interface slaves can be connected and integrated analog value transfer (according to the extended AS-Interface specification V2.1)
- Supports all AS-Interface master functions in accordance with the extended AS-Interface specification V2.1
- Status displays for operating states and display of the functional readiness of connected slaves with LEDs in the front panel
- Indication of errors (incl. AS-Interface voltage errors, configuration errors) with LEDs in the front panel
- Compact enclosure designed to match the SIMATIC S7-300

Technical specifications

	CP 343-2
AS-Interface Specification	V 2.1
Bus cycle time	5 ms for 31 slaves 10 ms for 62 slaves
Interfaces	
• Assignment of analog address space in the PLC	16 byte I/O and P-bus S7-300
• AS-Interface connection	S7-300 front connector with terminal
Supply voltage	+5 V DC through backplane bus
Current consumption	
• Through backplane bus	Typ. 200 mA at 5 V DC
• Through AS-Interface from the AS-Interface shaped cables	Max. 100 mA
Power loss	2 W
Perm. environmental conditions	
• Operating temperature	0°C to +60°C
• Transport/storage temperature	-40 °C to +70 °C
• Relative humidity, max.	95% at +25 °C
Design	
• Module format	S7-300 design
• Dimensions (W x H x D) in mm	40 x 125 x 120
• Weight	Approx. 190 g
• Space required	1 slot

Ordering data

Order No.

CP 343-2 communications processor	6GK7 343-2AH00-0XA0
For connection of SIMATIC S7-300 and ET 200M to the AS-Interface; without front connector	
Front connector	6ES7 392-1AJ00-0AA0
20-pin, with screw contacts	
CP 343-2 and CP 343-2 P manual	
including software (FC) and examples paper version	
• German	6GK7 343-2AH00-8AA0
• English	6GK7 343-2AH00-8BA0
• French	6GK7 343-2AH00-8CA0
• Spanish	6GK7 343-2AH00-8DA0
• Italian	6GK7 343-2AH00-8EA0
Electronic manuals	6GK1 975-1AA00-3AA0
Communication systems, logs, products	
on CD-ROM German/English	

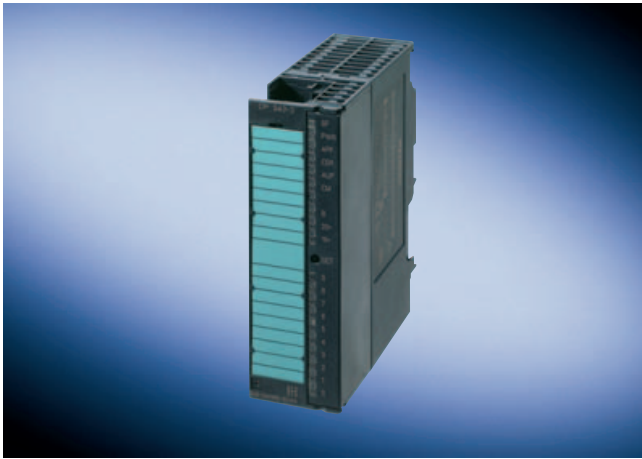
www.DataSheet4U.com
Overview

The CP 343-2 P is the AS-Interface master for the SIMATIC S7-300 programmable controller and the ET 200M distributed I/O station. The functions of the communications processor are as follows:

- **It supports configuration of the AS-Interface network with STEP 7 V5.2 and higher**
- Up to 62 AS-Interface slaves can be connected and integrated analog value transfer (according to the extended AS-Interface specification V2.1)
- Supports all AS-Interface master functions in accordance with the extended AS-Interface specification V2.1
- Indication of errors (incl. AS-Interface voltage errors, configuration errors) with LEDs in the front plate
- Compact enclosure designed to match the SIMATIC S7-300

4

Technical specifications

	CP 343-2 P
AS-Interface specification	V 2.1
Bus cycle time	5 ms for 31 slaves 10 ms for 62 slaves
Interfaces	
• Allocation of analog address space in the PLC	16 byte I/O and P-Bus S7-300
• AS-Interface connection	S7-300 front connector with terminal connection
Supply voltage	+5 V DC via backplane bus
Current consumption	
• Through backplane bus	Typ. 200 mA for 5 V DC
• Via AS-Interface from the AS-Interface shaped cables	max. 100 mA
Power loss	2 W
Perm. ambient conditions	
• Operating temperature	0 °C ... +60 °C
• Transport/storage temperature	-40 °C ... +70 °C
• Relative humidity, max.	95% at +25 °C
Construction	
• Module format	S7-300 construction
• Dimensions (W x H x D) in mm	40 x 125 x 120
• Weight	approx. 190 g
• Space requirements	1 slot
Configuring software	Optional: STEP 7 V5.2 and higher

Ordering data**Order No.**

CP 343-2 P communications processor	6GK7 343-2AH10-0XA0
For connection of SIMATIC S7-300 and ET 200M to the AS-Interface; without front connector	
Front connector	6ES7 392-1AJ00-0AA0
20-pin, with screw contacts	
CP 343-2 and CP 343-2 P manual	
including software (FC) and examples paper version	
• German	6GK7 343-2AH00-8AA0
• English	6GK7 343-2AH00-8BA0
• French	6GK7 343-2AH00-8CA0
• Spanish	6GK7 343-2AH00-8DA0
• Italian	6GK7 343-2AH00-8EA0
Electronic manuals	6GK1 975-1AA00-3AA0
Communication systems, logs, products on CD-ROM German/English	

SIMATIC S7-300

Communication

CP 342-5

www.DataSheet4U.com

Overview



- PROFIBUS DP master or slave with electrical interface for connecting the SIMATIC S7-300 and the SIMATIC C7 to PROFIBUS at up to 12 Mbit/s (including 45.45 kbit/s)
- Communication services:
 - PROFIBUS DP-V0
 - PG/OP communication (OP multiplexing)
 - S7 communication (client, server)
 - S5-compatible communication (SEND/RECEIVE)
- Easy configuration and programming over PROFIBUS
- Cross-network programming device communication through S7 routing
- Modules can be replaced without the need for a PG

DP-M	DP-S	PG	S7	S5	FMS
■	■	■	■	■	

Technical specifications

	CP 342-5
Data transmission rate	9.6 Kbps to 12 Mbps
Interfaces	
• Connection to PROFIBUS	9-pin Sub-D socket (RS 485)
• Connection to supply voltage	4-pin terminal block
Voltage supply	24 V DC
Current consumption	
• from the backplane bus	150 mA
• from 24 V	250 mA
Power loss	6.75 W
Perm. ambient conditions	
• Operating temperature	0 °C ... +60 °C
• Transport/storage temperature	-40 °C ... +70 °C
• Relative humidity	max. 95% at +25°C
Construction	
• Module format	Compact module
• Dimensions (W x H x D) in mm	40 x 125 x 120
• Weight	Approx. 300 g
Number of CPs per S7-300	4
Performance data	
S7 communication	
• Number of connections that can be used	max. 16

	CP 342-5
S5-compatible communication (SEND/RECEIVE)	
• Number of connections that can be used	max. 16
• Useful data / connection	max. 240 byte (SEND and RECEIVE)
Multi-protocol operation	
• Number of connections that can be used	max. 32 (without DP); max. 28 (with DP)
• Volume of DP data per connected DP slave	max. 240 byte
DP master function	
• DP master	DP-V0
• Number of operable DP slaves	124
• Size of DP data areas overall	
- DP input area	2160 byte
- DP output range	2160 byte
• Size of DP data areas per connected slave	
- DP input area	244 byte
- DP output range	244 byte
DP slave function	
• DP slave	DP-V0
• Size of DP data areas overall	
- DP input area	240 byte
- DP output range	240 byte
PG/OP communication	
• Number of operable OP connections (acyclic services)	16

Ordering data	Order No.		Order No.
CP 342-5 communications processor Communications processor for electrical connection of SIMATIC S7-300 to PROFIBUS to 12 Mbit/s with electronic manual on CD-ROM	6GK7 342-5DA02-0XE0	PROFIBUS FastConnect RS 485 bus connector With 90° cable outlet; With insulation displacement method, max. data transmission rate 12 Mbit/s	
NCM S7 configuration software for PROFIBUS Configuration software for PROFIBUS CPs for SIMATIC S7 <ul style="list-style-type: none"> V5.1 and newer executable under STEP 7 V5.1; with electronic manual on CD-ROM English, French, German, Italian and Spanish 	Delivered with STEP 7 Version 5	<ul style="list-style-type: none"> without PG interface with PG interface PROFIBUS bus connector IP20 For connection to PPI, MPI, PROFIBUS	6ES7 972-0BA50-0XA0 6ES7 972-0BB50-0XA0 6ES7 972-0BA12-0XA0 6ES7 972-0BB12-0XA0
"NCM S7 for PROFIBUS" manual Paper version for V5.x (STEP 7 V5.x) <ul style="list-style-type: none"> German English French Spanish Italian 	6GK7 080-5AA04-8AA0 6GK7 080-5AA04-8BA0 6GK7 080-5AA04-8CA0 6GK7 080-5AA04-8DA0 6GK7 080-5AA04-8EA0	PROFIBUS 12M bus terminal Bus terminal for connecting PROFIBUS stations up to 12 Mbit/s with connecting cable SIMATIC S7-300 DM 370 Dummy module; used during module replacement "Communication with SIMATIC" manual <ul style="list-style-type: none"> German English French Spanish Italian 	6GK1 500-0AA10 6ES7 370-0AA01-0AA0 6ES7 398-8EA00-8AA0 6ES7 398-8EA00-8BA0 6ES7 398-8EA00-8CA0 6ES7 398-8EA00-8DA0 6ES7 398-8EA00-8EA0

SIMATIC S7-300

Communication

CP 342-5 FO

www.DataSheet4U.com

Overview



- PROFIBUS DP master or slave with optical interface for connecting the SIMATIC S7-300 and the SIMATIC C7 to PROFIBUS at up to 12 Mbit/s (including 45.45 kbit/s)
- Direct connection to the optical PROFIBUS network over the integrated fiber-optic interface for plastic and PCF fiber-optic cables
- Communication services:
 - PROFIBUS DP-V0
 - PG/OP communication (OP multiplexing)
 - S7 communication (client, server)
 - S5-compatible communication (SEND/RECEIVE)
- Easy configuration and programming over PROFIBUS
- Cross-network programming device communication through S7 routing
- Modules can be replaced without the need for a PG

DP-M	DP-S	PG	S7	S5	FMS
■	■	■	■	■	

Technical specifications

	CP 342-5 FO
Data transmission rates	9.6 kbit/s to 12 Mbit/s (exception: 3 and 6 Mbit/s)
Interfaces	
• Connection to PROFIBUS	2 x duplex socket
• Connection to supply voltage	4-pin terminal block
Voltage supply	24 V DC
Current consumption	
• from the backplane bus	150 mA
• from 24 V DC	250 mA
Power loss	6.75 W
Maximum distance between two neighboring stations	
• Plastic fiber optic cables	max. 50 m
• PCF fiber optic cable	max. 300 m
Perm. ambient conditions	
• Operating temperature	0 °C ... +60 °C
• Transport/storage temperature	-40 °C ... +70 °C
• Relative humidity	max. 95% at +25°C
Construction	
• Module format	Compact module
• Dimensions (W x H x D) in mm	40 x 125 x 120
• Weight	approx. 300 g
• Number of CPs per S7-300	4
Performance data	
<u>S7 communication</u>	
• Number of connections that can be used	max. 16

	CP 342-5 FO
<u>S5-compatible communication (SEND/RECEIVE)</u>	
• Number of connections that can be used	max. 16
• Useful data / connection	max. 240 byte (Send and Receive)
<u>Multi-protocol operation</u>	
• Number of connections that can be used	32 (without DP); max. 28 (with DP)
<u>DP master function</u>	
• DP master	DP-V0
• Number of operable DP slaves	124
• Size of DP data areas overall	
- DP input area	2160 byte
- DP output range	2160 byte
• Size of DP data areas per connected slave	
- DP input area	244 byte
- DP output range	244 byte
• Volume of DP data per connected DP slave	Max. 240 byte
<u>DP slave function</u>	
• DP slave	DP-V0
• Size of DP data areas overall	
- DP input area	240 byte
- DP output range	240 byte
<u>PG/OP communication</u>	
• Number of operable OP connections (acyclic services)	16

SIMATIC S7-300

Communication

CP 342-5 FO

Ordering data	Order No.	Order No.
<p>CP 342-5 FO communications processor</p> <p>Communication processor for optical connection of SIMATIC S7-300 to PROFIBUS to 12 Mbit/s with electronic manual on CD-ROM</p>	<p>6GK7 342-5DF00-0XE0</p>	<p>Manual for PROFIBUS networks</p> <p>Paper version</p> <p>Network architecture, components (OLM (V3), OBT, ILM), configuring and installation</p> <ul style="list-style-type: none"> • German • English
<p>Configuring software NCM S7 for PROFIBUS</p> <p>Configuring software for PROFIBUS-CPs for SIMATIC S7 from V5.1, runs under STEP 7 V5.1; including Service Pack 3; with electronic manual on CD-ROM, German, English, French, Spanish, Italian</p>	<p>Delivered with STEP 7 Version 5</p>	<p>6GK1 970-5CA20-0AA0</p> <p>6GK1 970-5CA20-0AA1</p> <p>PROFIBUS Plastic Fiber Optic, Simplex Connector/Polishing Set</p> <p>100 simplex connectors and 5 polishing sets for assembling PROFIBUS plastic fiber optic cables for the optical PROFIBUS DP</p>
<p>Manual NCM S7 for PROFIBUS</p> <p>Paper version for V5.x (STEP 7 V5.x)</p> <ul style="list-style-type: none"> • German • English • French • Spanish • Italian 	<p>6GK7 080-5AA04-8AA0</p> <p>6GK7 080-5AA04-8BA0</p> <p>6GK7 080-5AA04-8CA0</p> <p>6GK7 080-5AA04-8DA0</p> <p>6GK7 080-5AA04-8EA0</p>	<p>PROFIBUS Plastic Fiber Optic, Stripping Tool Set</p> <p>Tools for removing the outer sheath or core sheath of Plastic Fiber Optic cables</p> <p>Plug-in adapter</p> <p>For assembling the plastic Simplex connector in combination with CP 342-5 FO, IM 467 FO, IM 153-2 FO and IM 151 FO</p> <p>50 units</p>

A) Subject to export regulations: AL: N and ECCN: EAR99H

4

SIMATIC S7-300

Communication

CP 343-5

www.DataSheet4U.com

Overview



DP-M	DP-S	PG	S7	S5	FMS
		■	■	■	■

Connection of SIMATIC S7-300 and SIMATIC C7 to PROFIBUS at up to 12 Mbit/s (including 45.45 kbit/s)

- Communication services:
 - PG/OP communication
 - S7 communication
 - S5-compatible communication (SEND/RECEIVE)
 - PROFIBUS FMS
- Easy configuration and programming over PROFIBUS
- Can be easily integrated into the S7-300 system
- Cross-network programming device communication through S7 routing
- Modules can be replaced without the need for a PG

Technical specifications

	CP 343-5
Data transmission rate	9.6 Kbps to 12 Mbps
Interfaces	
• Connection to PROFIBUS	9-pin Sub-D socket (RS 485)
• Connection to supply voltage	4-pin terminal block
Voltage supply	24 V DC
Current consumption	
• from the backplane bus	150 mA
• from 24 V	250 mA
Power loss	6.75 W
Perm. ambient conditions	
• Operating temperature	0 °C ... +60 °C
• Transport/storage temperature	-40 °C ... +70 °C
• Relative humidity	max. 95% at +25°C
Construction	
• Module format	Compact module
• Dimensions (W x H x D) in mm	40 x 125 x 120
• Weight	approx. 300 g
Number of CPs per S7-300	4

	CP 343-5
Performance data	
<u>S7 communication</u>	
• Number of connections that can be used	max. 16 ¹⁾
<u>S5-compatible communication (SEND/RECEIVE)</u>	
• Number of connections that can be used	max. 16
• Useful data / connection	max. 240 byte (SEND and RECEIVE)
<u>FMS function</u>	
• Number of connections that can be used	max. 16
Variable length for READ	237 byte
Variable length for WRITE and REPORT	233 byte
Configurable server variables	256
Variables that can be loaded from partners	256
<u>Multi-protocol operation</u>	
• Number of connections that can be used	max. 48

1) Dependent on the CPU used

Ordering data	Order No.	Order No.
<p>CP 343-5 communications processor</p> <p>Communication processor for connecting S7-300 to PROFIBUS, FMS, S5-compatible communication, PG/OP and S7 communication; with electronic manual on CD-ROM</p>	6GK7 343-5FA01-0XE0	<p>PROFIBUS FastConnect RS 485 bus connector</p> <p>With 90° cable outlet; With insulation displacement method, max. data transmission rate 12 Mbit/s</p> <ul style="list-style-type: none"> without PG interface with PG interface
<p>NCM S7 configuration software for PROFIBUS</p> <p>Configuration software for PROFIBUS CPs for SIMATIC S7 V5.x, executable under STEP 7 V5.x; with electronic manual on CD-ROM</p> <p>English, French, German, Italian and Spanish</p>	Delivered with STEP 7 Version 5	<p>PROFIBUS bus connector IP20</p> <p>For connection to PPI, MPI, PROFIBUS</p> <ul style="list-style-type: none"> without PG interface with PG interface
<p>"NCM S7 for PROFIBUS" manual</p> <p>Paper version for V5.x (STEP 7 V5.x)</p> <ul style="list-style-type: none"> German English French Spanish Italian 	<p>6GK7 080-5AA04-8AA0</p> <p>6GK7 080-5AA04-8BA0</p> <p>6GK7 080-5AA04-8CA0</p> <p>6GK7 080-5AA04-8DA0</p> <p>6GK7 080-5AA04-8EA0</p>	<p>PROFIBUS 12M bus terminal</p> <p>Bus terminal for connecting PROFIBUS stations up to 12 Mbit/s with connecting cable</p> <p>6GK1 500-0AA10</p>
		<p>"Communication with SIMATIC" manual</p> <ul style="list-style-type: none"> German English French Spanish Italian
		<p>SIMATIC S7-300 DM 370</p> <p>Dummy module; used during module replacement</p>
		<p>6ES7 972-0BA50-0XA0</p> <p>6ES7 972-0BB50-0XA0</p> <p>6ES7 972-0BA12-0XA0</p> <p>6ES7 972-0BB12-0XA0</p> <p>6ES7 398-8EA00-8AA0</p> <p>6ES7 398-8EA00-8BA0</p> <p>6ES7 398-8EA00-8CA0</p> <p>6ES7 398-8EA00-8DA0</p> <p>6ES7 398-8EA00-8EA0</p> <p>6ES7 370-0AA01-0AA0</p>

SIMATIC S7-300

Communication

CP 343-1 Lean

www.DataSheet4U.com

Overview



PN	ISO	TCP/IP	UDP	PG	S7	S5	IT	FTP
■		■	■	■	■	■		

- Interface for the SIMATIC S7-300 to Industrial Ethernet
 - 2 x RJ45 connection for 10/100 Mbit/s full/half duplex connection (with Autosensing for automatic switchover and autocrossover function)
 - integral 2-port real-time switch ERTEC 200
 - multi-protocol operation with TCP and UDP transport protocol and PROFINET IO
 - Keep Alive function
- Communication services:
 - open IE communication (TCP/IP and UDP)
 - PG/OP communication
 - S7 communication (server)
 - S5 compatible communication
- Multicast for UDP
- Remote programming and initial start-up is possible exclusively over Industrial Ethernet
- Integration into network management through SNMP
- Configuration with NCM S7 for Industrial Ethernet (integrated into STEP 7)
- Cross-network programming device/operator panel communication through S7 routing

Technical specifications

	CP 343-1 Lean
Data transmission rate	10/100 Mbit/s autosensing
Interfaces	<ul style="list-style-type: none"> • Communication connection, electrical: 2 x RJ45 sockets (10/100 Mbit/s; TP) • Connection for supply voltage: 1 x 2-pin plug-in terminal block
Voltage supply	+24 VDC (permissible range: +20.4 V to +28.8 V)
Current consumption	<ul style="list-style-type: none"> • from the backplane bus: max. 200 mA • from 24 V DC external: typ. 160 mA, max. 200 mA
Power loss	5.8 W
Permissible ambient conditions	<ul style="list-style-type: none"> • Operating temperature: 0 °C ... +60 °C • Transport/storage temperature: -40 °C ... +70 °C • Relative humidity: max. 95% at +25 °C
Design	<ul style="list-style-type: none"> • Module format: Compact module S7-300, single width • Dimensions (W x H x D) in mm: 40 x 125 x 120 • Weight: approx. 200 g
Configuring software	NCM S7 for Industrial Ethernet (supplied with STEP 7)

	CP 343-1 Lean
Performance data	
Open IE/S5-compatible communication (SEND/RECEIVE)	
• Sum of all simultaneously operable TCP/UDP connections	max. 8
• Useful data	
- TCP	8 KB
- UDP	2 KB
S7 communication	
• Number of connections	max. 4
PG/OP communication	
• Number of operable OP connections (acyclic services)	max. 4
Multi-protocol operation	
• Sum of all simultaneously operable connections	max. 12
Multicast	8
PROFINET communication (PN IO-Device)	
• Size of I/O data areas overall	
- I/O input area	512 byte
- I/O output area	512 byte
• Size of I/O data areas per connected sub-module	
- inputs	max. 240 byte
- outputs	max. 240 byte
• Number of sub-modules	max. 32

Ordering data	Order No.	Order No.
<p>CP 343-1 Lean communications processor</p> <p>For connecting SIMATIC S7-300 to Industrial Ethernet through TCP/IP and UDP Multicast, S7 communication, S5-compatible communication with SEND/RECEIVE, FETCH/WRITE, PROFINET IO device, integrated 2-port switch ERTEC 200, diagnostic expansions, replacement of devices without PG, SNMP, initial start-up over LAN 10/100 Mbit/s; with electronic manual on CD-ROM</p>	<p>A) 6GK7 343-1CX10-0XE0</p>	<p>IE FC RJ45 Plug 180</p> <p>RJ45 plug-in connector for Industrial Ethernet with a rugged metal housing and integrated insulation displacement contacts for connecting Industrial Ethernet FC installation cables; with 180° cable outlet; for network components and CPs/CPU with Industrial Ethernet interface</p> <ul style="list-style-type: none"> • 1 pack = 1 piece • 1 pack = 10 pieces • 1 pack = 50 pieces <p>6GK1 901-1BB10-2AA0 6GK1 901-1BB10-2AB0 6GK1 901-1BB10-2AE0</p>
<p>NCM S7 configuration software for Industrial Ethernet</p> <p>NCM S7 configuration software version 5.4 for Industrial Ethernet CPs; in addition hardware support package (HSP) for CP 343-1 Lean¹⁾.</p> <p>To use the known functions of the CP 343-1 Lean (...0CX00-..), the new version of the CP 343-1 Lean (...0CX10-..) can be configured as a CP 343-1 (...0CX00-..) similar to the handling of the CP as a spare part; (configuring software NCM S7 V5.2 SP3 or higher for Industrial Ethernet CPs, running under STEP 7 V5.2 and HSP); for execution under STEP 7 V5.4; on CD-ROM, with electronic manual in English, German, French, Spanish and Italian</p>	<p>Delivered with STEP 7 V5.4</p>	<p>Documentation S7-CPs/NCM S7</p> <p>For Industrial Ethernet and PROFIBUS; manual package for configuring S7-CPs, IE/PB link and PC stations (STEP 7 V5.3)</p> <ul style="list-style-type: none"> • German • English <p>6GK7 080-0AA01-8AA0 6GK7 080-0AA01-8BA0</p>

1) The HSP for CP 343-1 Lean (...0CX10-..) can be loaded and installed directly from the Internet by means of STEP 7. It is a part of STEP 7 V5.4 SP1 or higher.

A) Subject to export regulations: AL: N and ECCN: EAR99H

SIMATIC S7-300

Communication

CP 343-1

Overview



PN	ISO	TCP/IP	UDP	PG	S7	S5	IT	FTP
■	■	■	■	■	■	■		

- Connection of SIMATIC S7-300 to Industrial Ethernet
 - 10/100 Mbit/s full/half duplex connection with autosensing
 - connection for RJ45
 - multi-protocol operation with TCP and UDP transport protocol
 - adjustable Keep Alive function
- Communication services:
 - open IE communication (TCP/IP and UDP)
 - PROFINET IO Controller
 - PROFINET CBA
 - Programming device/operator panel communication: Cross-network by means of S7 routing
 - S7 communication (client, server, multiplexing)
 - S5-compatible communication
- Multicast for UDP
- IP address assignment via DHCP, simple PC tool or via the user program (e.g. HMI)
- Access protection by means of configurable access list
- Remote programming and initial startup via the network
- Automatic setting of the CPU clock via Ethernet with NTP or SIMATIC procedure
- SNMP MIB2 diagnostics information for network management systems

Technical specifications

	CP 343-1
Data transmission rate	10/100 Mbit/s autosensing
Interfaces	
• Communication connection, electrical	1 x RJ45 (10/100 Mbit/s; TP)
• Connection for supply voltage	1 x 2-pin plug-in terminal block
Slot for the swap medium	C-PLUG
Voltage supply	+5 V DC (±5%) and b+24 V DC (±5%)
Current consumption	
• from the backplane bus	200 mA
• from 24 V DC external	typ. 160 mA max. 200 mA
Power loss	5.8 W
Permissible ambient conditions	
• Operating temperature	0 °C ... +60 °C
• Transport/storage temperature	-40 °C ... +70 °C
• Relative humidity	max. 95% at +25 °C
Design	
• Module format	Compact module S7-300, double width
• Dimensions (W x H x D) in mm	80 x 125 x 120
• Weight	approx. 600 g
Configuring software	STEP 7 V5.3 SP2 and higher

	CP 343-1
Performance data	
Open IE/S5-compatible communication (SEND/RECEIVE)	
• Sum of all simultaneously operable TCP/UDP connections	max. 16
• Useful data	
- TCP	8 KB
- UDP	2 KB
S7 communication	
• Number of connections	max. 16
PG/OP communication	
• Number of operable OP connections (acyclic services)	16
Multi-protocol operation	
• Sum of all simultaneously operable connections	max. 48
Multicast	16
PROFINET communication	
PROFINET IO Controller	
• Number of operable PN IO-Devices	125
• Size of IO data areas overall	
- I/O input area	2160 byte
- I/O output area	2160 byte
• Size of I/O data areas per connected PN IO device	
- I/O input area	max. 128 byte
- I/O output area	max. 128 byte

www.DataSheet4U.com
Technical specifications (continued)

	CP 343-1		CP 343-1
PROFINET CBA		Remote interconnections with cyclic transmission	
• Number of remote interconnecting partners	64	• Transmission frequency: Transmission time, min. Possible settings: 10, 20, 50, 100, 200, 500 and 1000 ms	10 ms
• Sum of all connections	1000	• Number of incoming interconnections, max.	200
• Data length of all incoming connections	8192 Byte	• Number of outgoing interconnections, max.	200
• Data length of all outgoing connections	8192 Byte	• Data length of all incoming interconnections	2000 Byte
• Data length for arrays and structures (acyclic interconnection), max.	8192 Byte	• Data length of all outgoing interconnections	2000 Byte
• Data length for arrays and structures (cyclic interconnection), max.	450 Byte	HMI variables via PROFINET (acyclic)	
• Data length for arrays and structures (local interconnection), max.	2400 Byte	• Number of stations for HMI variables that can connect (PN OPC/iMap); stations are 2 x PN OPC and 1 x SIMATIC iMap	3
• Remote interconnections with acyclic transmission		• Update HMI variables, min.	500 ms
• Scan rate: Sampling time, min. Possible settings: 100, 200, 500 and 1000 ms	100 ms	• Number of HMI variables, max.	200
• Number of incoming interconnections, max.	128	• Data length of all HMI variables	8192 Byte
• Number of outgoing interconnections, max.	128	Internal device interconnections	
• Data length of all incoming interconnections	8192 Byte	• Number of internal interconnections	256
• Data length of all outgoing interconnections	8192 Byte	• Data length of all internal interconnections	2400 Byte
		Interconnections with constants	
		• Number of interconnections with constants, max.	200
		• Data lengths of all interconnections with constants.	4096 Byte
		PROFIBUS proxy functionality	
		No	
		Access to S7extended variables	
		• Maximum number of S7 connections for access to variables with the PROFINET attribute "S7extended", max.	32

SIMATIC S7-300

Communication

CP 343-1

4

www.DataSheet4U.com

Ordering data	Order No.	Order No.	
CP 343-1 communications processor For connection of SIMATIC S7-300 to Industrial Ethernet; PROFINET IO Controller, PROFINET CBA, TCP/IP and UDP, S7 communication, S5-compatible communication (SEND/RECEIVE), FETCH/WRITE, with and without RFC 1006, diagnostic expansions, multicast, CPU clock synchronization via SIMATIC procedure and NTP, access protection through IP access list, SNMP, DHCP, initialization over LAN 10/100 Mbit/s; with electronic manual on CD-ROM	6GK7 343-1EX21-0XE0	SOFTNET-S7 Lean Edition 2005 for Industrial Ethernet Software for S7 and S5-compatible communication, incl. OPC server, PG/OP communication and NCM PC; up to 8 connections, single license for 1 installation, runtime software, software and electronic manual on CD-ROM, license key on diskette, Class A, for 32-bit Windows XP Professional, 2003 Server, 2000 Professional/Server; German/English	6GK1 704-1LW63-3AA0
C-PLUG A) Swap medium for simple replacement of devices in the event of a fault; for storing configuration or engineering and application data; can be used for SIMATIC NET products with C-PLUG slot	6GK1 900-0AB00	S7-1613 Edition 2005 Software for S7 and S5 communication, incl. PG/OP communication, OPC server and NCM PC; up to 120 connections, single license for 1 installation, runtime software, software and electronic manual on CD-ROM, license key on diskette, Class A, for 32-bit Windows XP Professional, 2003 Server, Windows 2000 Professional/Server; for CP 1613/CP 1613 A2 German/English	6GK1 716-1CB63-3AA0
IE FC RJ45 Plug 180 RJ45 plug-in connector for Industrial Ethernet with a rugged metal housing and integrated insulation displacement contacts for connecting Industrial Ethernet FC installation cables; with 180° cable outlet; for network components and CPs/CPU with Industrial Ethernet interface	6GK1 901-1BB10-2AA0 6GK1 901-1BB10-2AB0 6GK1 901-1BB10-2AE0	NCM S7 configuration software for Industrial Ethernet for Industrial Ethernet CPs for SIMATIC S7 V5.3 SP2, operating under STEP 7 V5.3; on CD-ROM with electronic manual in German, English, French, Spanish, Italian	Delivered with STEP 7 V5.3
<ul style="list-style-type: none"> • 1 pack = 1 unit • 1 pack = 10 units • 1 pack = 50 units 		Documentation S7-CPs/NCM for Industrial Ethernet and PROFIBUS for V5.x (STEP 7 V5.x); paper version	
SOFTNET-S7 Edition 2005 for Industrial Ethernet Software for S7 and S5-compatible communication, incl. OPC server, PG/OP communication and NCM PC; up to 64 connections, single license for 1 installation, runtime software, software and electronic manual on CD-ROM, license key on diskette, Class A, for 32-bit Windows XP Professional, 2003 Server, 2000 Professional/Server; German/English	6GK1 704-1CW63-3AA0	<ul style="list-style-type: none"> • German • English 	6GK7 080-0AA01-8AA0 6GK7 080-0AA01-8BA0
		SIMATIC iMap V3.0 for configuring PROFINET CBA, <i>Requirement:</i> Windows 2000 Prof. with Service Pack 4 or later or Windows XP Prof. with Service Pack 1 or later or Windows 2003 Server with Service Pack 1 or later; on PG or PC with Pentium processor, min. 1 GHz; STEP 7 V5.3 or later with Service Pack 3, PN OPC Server V6.3 or later <i>Type of supply:</i> German, English with electronic documentation	
		<ul style="list-style-type: none"> • Single license D) 6ES7 820-0CC04-0YA5 • Software Update Service D) 6ES7 820-0CC01-0YX2 • Upgrade to V3.0, single license D) 6ES7 820-0CC04-0YE5 	

A) Subject to export regulations: AL: N and ECCN: EAR99H

D) Subject to export regulations: AL: N and ECCN: 5D992B1

www.DataSheet4U.com
Overview

PN	ISO	TCP/IP	UDP	PG	S7	S5	IT	FTP
■	■	■	■	■	■	■	■	■

- Connection of SIMATIC S7-300 to Industrial Ethernet
 - 10/100 Mbit/s full/half duplex connection with autosensing
 - Connection for RJ45
 - Multi-protocol operation with TCP and UDP transport protocol
 - Adjustable Keep Alive function
- Communication services:
 - Open IE communication (TCP/IP and UDP):
 - Multicast for UDP
 - PROFINET IO controller
 - PROFINET CBA
 - Programming device/operator panel communication:
 - Cross-network by means of S7 routing
 - S7 communication (client, server, multiplexing)
 - S5-compatible communication
 - IT communication:
 - HTTP communication supports access to process data through Web browsers;
 - FTP communication supports program-controlled FTP client communication,
 - Access to data blocks through FTP server,
 - Data handling for own file system through FTP,
 - E-mail
- IP address assignment via DHCP, simple PC tool or via program block (e.g. for HMI)
- Access protection by means of configurable access list
- Module replacement without programming device; all information is stored on the C-PLUG (also file system for IT functions).
- Extensive diagnostic functions for all modules in the rack
- Integration into network management systems through the support of SNMP V1 MIB-II

Technical specifications

	CP 343-1 Advanced
Data transmission rate	10/100 Mbit/s
Interfaces	
• Communication connection, electrical	1 x RJ45 (10/100 Mbit/s; TP) Autosensing/Autocrossover/Autonegotiation
• Connection for supply voltage	1 x 2-pin plug-in terminal block
• Slot for the swap medium	C-PLUG
Voltage supply	+5 V DC (±5%) and +24 V DC (±5%)
Current consumption	
• from the backplane bus	200 mA
• from 24 V DC external	typ. 160 mA max. 200 mA
Power loss	5.8 W
Perm. ambient conditions	
• Operating temperature	0 °C ... +60 °C
• Transport/storage temperature	-40 °C ... +70 °C
• Relative humidity	Max. 95% at +25 °C
Construction	
• Module format	Compact module S7-300, double width
• Dimensions (W x H x D) in mm	80 x 125 x 120
• Weight	Approx. 600 g
Configuring software	STEP 7 V5.3 SP3 and higher

	CP 343-1 Advanced
Performance data	
Open IE/S5-compatible communication (SEND/RECEIVE)	
• Sum of all simultaneously operable TCP/UDP connections	max. 16
• Useful data	
- TCP	8 KByte
- UDP	2 KByte
S7 communication	
• Number of connections	max. 16
PG/OP communication	
• Number of operable OP connections (acyclic services)	16
Multi-protocol operation	
• Sum of all simultaneously operable connections	max. 48
Multicast	16
FTP communication	
• Number of client connections	max. 10
• Number of server connections	max. 2
IT communication	
Number of connections to an Email server	max. 1
Memory capacity	
• Flash memory file system	30 MByte
• RAM memory	30 MByte

SIMATIC S7-300

Communication

CP 343-1 Advanced

Technical specifications (continued)

	CP 343-1 Advanced
Service life of the Flash Memory cells	Approx. 100000 write cycles
PROFINET communication	
PROFINET IO Controller	
• Number of operable PN IO-Devices	125
• Size of IO data areas overall	
- I/O input area	2160 Byte
- I/O output area	2160 Byte
• Size of I/O data areas per connected PN IO device	
- I/O input area	max. 128 Byte
- I/O output area	max. 128 Byte
PROFINET CBA	
Number of remote interconnecting partners	64
Swapped connectors	1000
Data length of all incoming connections	8192 Byte
Data length of all outgoing connections	8192 Byte
Data length for arrays and structures (acyclic interconnection), max.	8192 Byte
Data length for arrays and structures (cyclic interconnection), max.	450 Byte
Data length for arrays and structures (local interconnection), max.	2400 Byte
Remote interconnections with acyclic transmission	
• Scan rate: Sampling time, min. Possible settings: 100, 200, 500 and 1000 ms	100 ms
• Number of incoming interconnections, max.	128
• Number of outgoing interconnections, max.	128
• Data length of all incoming interconnections	8192 Byte
• Data length of all outgoing interconnections	8192 Byte

	CP 343-1 Advanced
Remote interconnections with cyclic transmission	
• Transmission frequency: Transmission time, min. Possible settings: 10, 20, 50, 100, 200, 500 and 1000 ms	10 ms
• Number of incoming interconnections, max.	200
• Number of outgoing interconnections, max.	200
• Data length of all incoming interconnections	2000 Byte
• Data length of all outgoing interconnections	2000 Byte
HMI variables via PROFINET (acyclic)	
• Number of stations for HMI variables that can connect (PN OPC/iMap); stations are 2 x PN OPC and 1 x SIMATIC iMap	3
• Update HMI variables, min.	500 ms
• Number of HMI variables, max.	200
• Data length of all HMI variables	8192 Byte
Internal device interconnections	
• Number of internal interconnections	256
• Data length of all internal interconnections	2400 Byte
Interconnections with constants	
• Number of interconnections with constants, max.	200
• Data lengths of all interconnections with constants.	4096 Byte
PROFIBUS proxy functionality	No
Access to S7extended variables	
• Maximum number of S7 connections for access to variables with the PROFINET attribute "S7extended", max.	32

Ordering data	Order No.	Order No.	
<p>Communications processor CP 343-1 Advanced</p> <p>For the connection of SIMATIC S7-300 to Industrial Ethernet; PROFINET IO Controller, PROFINET CBA, TCP/IP and UDP, S7 communication, S5-compatible communication (SEND/RECEIVE), FETCH/WRITE, with and without RFC 1006, diagnostics expansions, multicast, Web server, HTML diagnostics, FTP server, FTP client, E-mail client, setting of CPU's clock using SIMATIC and NTP procedures, access protection through IP access list, SNMP, DHCP, initialization over LAN 10/100 Mbit/s; with electronic manual on CD-ROM</p>	6GK7 343-1GX21-0XE0	<p>S7-1613 Edition 2005</p> <p>Software for S7 and S5 communication, incl. PG/OP communication, OPC server and NCM PC; up to 120 connections, single license for 1 installation, runtime software, software and electronic manual on CD-ROM, license key on diskette, Class A, for 32-bit Windows XP Professional, 2003 Server, Windows 2000 Professional/Server; for CP 1613/CP 1613 A2 German/English</p>	6GK1 716-1CB63-3AA0
<p>C-PLUG A)</p> <p>Swap medium for simple replacement of devices in the event of a fault; for storing configuration or engineering and application data; can be used for SIMATIC NET products with C-PLUG slot</p>	6GK1 900-0AB00	<p>NCM S7 configuration software for Industrial Ethernet</p> <p>Configuration software for Industrial Ethernet CPs for SIMATIC S7 V5.3 SP2, operating under STEP 7 V5.3; on CD-ROM with electronic manual in German, English, French, Spanish, Italian</p>	Delivered with STEP 7 V5.3
<p>SOFTNET-S7 Edition 2005 for Industrial Ethernet</p> <p>Software for S7 and S5-compatible communication, incl. OPC server, PG/OP communication and NCM PC; up to 64 connections, single license for 1 installation, runtime software, software and electronic manual on CD-ROM, license key on diskette, Class A, for 32-bit Windows XP Professional, 2003 Server, 2000 Professional/Server; German/English</p>	6GK1 704-1CW63-3AA0	<p>Documentation S7-CPs/NCM for Industrial Ethernet and PROFIBUS</p> <p>for V5.x (STEP 7 V5.x); paper version</p> <ul style="list-style-type: none"> • German • English 	<p>6GK7 080-0AA01-8AA0</p> <p>6GK7 080-0AA01-8BA0</p>
<p>SOFTNET-S7 Lean Edition 2005 for Industrial Ethernet</p> <p>Software for S7 and S5-compatible communication, incl. OPC server, PG/OP communication and NCM PC; up to 8 connections, single license for 1 installation, runtime software, software and electronic manual on CD-ROM, license key on diskette, Class A, for 32-bit Windows XP Professional, 2003 Server, 2000 Professional/Server; German/English</p>	6GK1 704-1LW63-3AA0	<p>SIMATIC iMap V3.0</p> <p>for configuring PROFINET CBA,</p> <p><i>Prerequisite:</i> Windows 2000 Prof. with Service Pack 4 or later or Windows XP Prof. with Service Pack 1 or later or Windows 2003 Server with Service Pack 1 or later; on PG or PC with Pentium processor, min. 1 GHz; STEP 7 V5.3 or later with Service Pack 3, PN OPC Server V6.3 or later</p> <p><i>Type of delivery:</i> German, English with electronic documentation</p> <ul style="list-style-type: none"> • Single license D) 6ES7 820-0CC04-0YA5 • Software Update Service D) 6ES7 820-0CC01-0YX2 • Upgrade to V3.0, single license D) 6ES7 820-0CC04-0YE5 	

A) Subject to export regulations: AL: N and ECCN: EAR99H

D) Subject to export regulations: AL: N and ECCN: 5D992B1

SIMATIC S7-300

Connection methods

Front connectors

www.DataSheet4U.com
Overview



- For simple and user-friendly connection of sensors and actuators
- For retaining the wiring when replacing modules
- With coding to avoid mistakes when replacing modules

Ordering data

Order No.

Front connectors

20-pin, with screw contacts

- 1 unit
- 100 units

6ES7 392-1AJ00-0AA0

6ES7 392-1AJ00-1AB0

20-pin, with cage clamp terminals

- 1 unit
- 100 units

6ES7 392-1BJ00-0AA0

6ES7 392-1BJ00-1AB0

40-pin, with screw contacts

- 1 unit
- 100 units

6ES7 392-1AM00-0AA0

6ES7 392-1AM00-1AB0

40-pin, with cage clamp terminals

- 1 unit
- 100 units

6ES7 392-1BM01-0AA0

6ES7 392-1BM01-1AB0

Front door, elevated design ^{A)}

6ES7 328-0AA00-7AA0

e.g. for 32 channel modules;
 enables connection of
 1.3 mm²/16 AWG wires

A) Subject to export regulations: AL: N and ECCN: EAR99H

SIMATIC S7-300

Connection methods

Fully modular connection

www.DataSheet4U.com

Overview



The fully modular connection is the standard connection for the SIMATIC S7-300/400. The fully modular connection facilitates convenient, fast, and correct connection of the I/O to the SIMATIC S7-300/400.

- Easy plugging in of front connector module, connecting cable and connection module
- Fast and low-cost wiring
- Supply voltage connectable to front connector module or connection module for digital and analog signals
- Reduction in wiring errors, clear control cabinet wiring
- Distribution of digital signals by byte or by double-byte
- Each component can be replaced individually.
- Every cable length can be configured without cutting, or pre-assembled cables can be used

Connecting cables



The connection cable is the linking element between the front connector module and the connection module. It transmits 8 signals and the supply voltage. The maximum bridgeable distance is 30 m. The connecting cable is available in two different versions:

- The pre-assembled round cable
- The round-sheath ribbon cable assembled by the user

Basic modules



In the case of the basic module, the connection modules are used with basic functionality. Here, the I/O signal is connected quickly and simply from the field to the module or from the module to the field.

The connection terminals for the I/O signals are designed as screw terminals or spring terminals. The connection modules are available for digital and analog signals.

Signal modules



In the case of the signal module, the digital connection modules with LED are used. The yellow LEDs indicate the "active high" signal of the individual channels. This makes commissioning easier for you, and you always have an overview of the signal states of your I/O. At the same time, a green LED indicates when the 24 V DC is applied.

The connection terminals for the I/O signals are designed as screw terminals or spring terminals. The connection modules are available for digital signals.

SIMATIC S7-300

Connection methods

Fully modular connection

www.DataSheet4U.com
Overview (continued)

Function modules



Function modules are implemented with digital connection modules fitted with relays or optocouplers.

If other voltage or power levels are required in the field, the connection module for output signals TPRo is used. This converts the 24 V DC output signal simply and reliably to another voltage or power level. If 230 V AC input signals have to be transmitted to the controller in the field, a connection module with relay TPRi is available that converts the 230 V AC signal simply to 24 V DC. This means you always have the same voltage level on the module side.

Technical specifications front connector modules

Technical data of front connector module

Rated operating voltage	DC 24 V
Max. permissible operating voltage	DC 60 V
Max. permissible continuous current	1 A
• per connector pin	
Max. permissible summation current	4 A/Byte
Permissible ambient temperature	0 to + 60°C
Test voltage	0.5 kV, 50 Hz, 60 sec.
Air gaps and creepage distances	IEC 664 (1980), IEC 664 A (1981), in accordance with DIN VDE 0110 (01.89), overvoltage class II, pollution degree 2

Front connector module SIMATIC TOP connect, connection for potential infeed Modules up to 4 connections

Spring connection Screw connection

Connectable cable cross-sections

solid cables	No
flexible cables with/without wire end ferrule	0.25 to 1.5 mm ²
Number of wires per connection	1 or a combination of 2 conductors up to 1.5 mm ² (total) in a common wire end ferrule
Max. diameter of the cable insulation	3.1 mm
Stripping length of the cables	
• without insulating collar	6 mm
• with insulating collar	-
Wire-end ferrules in acc. with DIN 46228	
• without insulating collar	Form A; 5 to 7 mm long
• with insulating collar 0.25 to 1.0 mm ²	-
• with insulating collar 1.5 mm ²	-

Front connector module SIMATIC TOP connect, connection for potential infeed Modules up to 4 connections

Spring connection Screw connection

Blade width of the screwdriver	3.5 mm (cylindrical shape)	
Tightening torque for connecting the cables	-	0.4 to 0.7 Nm

Front connector module SIMATIC TOP connect, connection for potential infeed Modules up to 8 connections

Spring connection Screw connection

Connectable cable cross-sections

solid cables	No	
flexible cables with/without wire end ferrule	0.25 to 0.75 mm ²	
Number of cables per connection	1 or a combination of 2 wires up to 0.75 mm ² (total) in a common wire end ferrule	
Max. diameter of the cable insulation	2.0 mm	
Stripping length of the cables		
• without insulating collar	6 mm	
• with insulating collar	-	
Wire-end ferrules in acc. with DIN 46228		
• without insulating collar	Form A; 5 to 7 mm long	
• with insulating collar 0.25 to 1.0 mm ²	-	
• with insulating collar 1.5 mm ²	-	
Blade width of the screwdriver	3.5 mm (cylindrical shape)	
Tightening torque for connecting the cables	-	0.4 to 0.7 Nm

SIMATIC S7-300

Connection methods

Fully modular connection

4

Technical specifications connection cables

Technical data of connecting cable from SIMATIC S7 to connection module

Operating voltage	60 V DC
Continuous current per signal conductor	1 A
Max. summation current	4 A/byte
Operating temperature	0 to +60°C
Outer diameter of pre-assembled round cable in mm, unshielded/shielded	Approx. 6.5/7.0
Outer diameter of round-sheath ribbon cable in mm, 16-pole/2 x 16-pole	Approx. 9.5/11.5

Technical specifications basic modules

Connection module TP1, TP3 and TPK

Max. operating voltage	60 V DC
Continuous current per signal	1 A
Max. summation current (voltage infeed)	4 A/byte
Operating temperature	0 to +60°C
Mounting position	Any
Air gaps and creepage distances	IEC Report 664, IEC 664 A, IEC 1131 T2, CSA C22.2 No 142 UL 508, VDE 0160 (12.90), overvoltage category II, pollution degree 3
Dimensions (W x H x D) in mm	<ul style="list-style-type: none"> • 1-wire connection 6ES7924-0AA10-0A_0 Approx. 55 x 43.2 x 63 • for 3-wire initiators 6ES7924-OCA10-0A_0 Approx. 68 x 43.2 x 80 • for 2 x 8 signals 6ES7924-1AA10-0A_0 Approx. 100 x 43.2 x 80

Connection module TP2

Max. operating voltage	60 V DC
Continuous current signal conductor	2 A
Operating temperature	0 to +60°C
Mounting position	Any
Air gaps and creepage distances	IEC Report 664, IEC 664 A, IEC 1131 T2, CSA C22.2 No 142 UL 508, VDE 0160 (12.90), overvoltage category II, pollution degree 3
Dimensions (W x H x D) in mm	<ul style="list-style-type: none"> • for 2 ampere modules 6ES7924-0BB10-0A_0 Approx. 68 x 43.2 x 80

Technical specifications basic modules (continued)

Connection module TPA

Max. operating voltage	60 V DC
Continuous current signal conductor	1 A
Operating temperature	0 to +60 °C
Mounting position	Any
Air gaps and creepage distances	IEC Report 664, IEC 664 A, IEC 1131 T2, CSA C22.2 No 142 UL 508, VDE 0160 (12.90), overvoltage category II, pollution degree 3
Dimensions (W x H x D) in mm	Approx. 68 x 43.2 x 80
• for 2 analog modules 6ES7924-0CC10-0A_0	

Connection module TPA, TP1, TP2, TP3, TPK

	Spring connection	Screw connection
Connectable cable cross-sections	<ul style="list-style-type: none"> • solid cables No • flexible cables without wire end ferrule 0.5 to 2.5 mm² • flexible cables with wire end ferrule in accordance with DIN 46228/1 0.5 to 1.5 mm² • flexible cables with wire end ferrule and plastic collar in accordance with DIN 46228/4 0.5 to 1.5 mm² 	
	0.5 to 2.5 mm ² (2.5 mm ² with a crimp in accordance with EN 60947-1)	
Number of cables per connection	1 or a combination of 2 cables up to the cross-sections specified above (total) in a shared wire end ferrule	
Blade width of the screw-driver	3.5 mm (cylindrical shape)	
Tightening torque for connecting the cables	-	0.4 to 0.7 Nm

SIMATIC S7-300

Connection methods

Fully modular connection

Technical specifications signal modules

Connection module TP1, TP3 and TPK with LED

Max. operating voltage	24 V DC
Continuous current per signal	1 A
Max. summation current (voltage infeed)	4 A/byte
Operating temperature	0 to + 60 °C
Mounting position	Any
Air gaps and creepage distances	IEC Report 664, IEC 664 A, IEC 1131 T2, CSA C22.2 No 142 UL 508, VDE 0160 (12.90), overvoltage category II, pollution degree 3
Dimensions (W x H x D) in mm	
• 1-wire connection with LED 6ES7924-0AA10-0B_0	Approx. 55 x 43.2 x 63
• for 3-wire initiators with LED 6ES7924-0CA10-0B_0	Approx. 68 x 43.2 x 80
• for 2 x 8 signals with LED 6ES7924-1AA10-0B_0	Approx. 100 x 43.2 x 80

Connection module TP2 with LED

Max. operating voltage	24 V DC
Continuous current per signal conductor	2 A
Operating temperature	0 to + 60 °C
Mounting position	Any
Air gaps and creepage distances	IEC Report 664, IEC 664 A, IEC 1131 T2, CSA C22.2 No 142 UL 508, VDE 0160 (12.90), overvoltage category II, pollution degree 3
Dimensions (W x H x D) in mm	
• for 2-ampere modules with LED 6ES7924-0BB10-0B_0	Approx. 68 x 43.2 x 80

Connection module TP1 LED, TPK LED, TP2 LED, TP3 LED

	Spring connection	Screw connection
Connectable cable cross-sections		
• solid cables	No	
• flexible cables without wire end ferrule	0.5 to 2.5 mm ²	
• flexible cables with wire end ferrule in accordance with DIN 46228/1	0.5 to 1.5 mm ²	0.5 to 2.5 mm ² (2.5 mm ² with a crimp in accordance with EN 60947-1)
• flexible cables with wire end ferrule and plastic collar in accordance with DIN 46228/4	0.5 to 1.5 mm ²	
Number of wires per connection	1 or a combination of 2 conductors up to the cross-sections specified above (total) in a shared wire end ferrule	
Blade width of the screw-driver	3.5 mm (cylindrical shape)	
Tightening torque for connecting the cables	-	0.4 to 0.7 Nm

Technical specifications function modules

Connection module with relay for outputs (TPRo)

Energizing side	
Operating voltage for coil	24 V DC
Input circuit	Reverse polarity protection and freewheeling diodes
Contact side	
Number of relay outputs	8 (NO contacts)
Contact design	Single contact, 1 NO contact
Switching capacity (resistive load)	max. 4 A/250 V AC, max. 3 A/30 V DC max. 0.6 A/48 V DC max. 0.4 A/60 V DC recommended minimum load ≥ 10 mA
Switching frequency	20 cycles/minute
Service life	
• mechanical	5 x 10 ⁶ operating cycles
• electrical	3 x 10 ⁴ operating cycles at 230 V AC/2 A/ cos φ = 1
Operating temperature	0 to +60 °C
Mounting position	Any
Air gaps and creepage distances	Basic standard IEC 60664-1; UL 508; Cul (Reference CSA C22.2 No. 142) overvoltage category III pollution degree 2
Dimensions (W x H x D) in mm	
6ES7924-0BD10-0B_0	Approx. 100 x 45 x 80

Connection module with relay for inputs (TPRi)

Energizing side	
Operating voltage for coil	230 V AC
	from 207 – 280 V AC
Input circuit	Varistors
Contact side	
Number of relay outputs	8 (NO contacts)
Contact design	Single contact, 1 NO contact
Switching capacity (resistive load)	max. 50 mA/24 V AC, max. 50 mA/48 V DC max. 50 mA/60 V DC recommended minimum load ≥ 5 mA
Switching frequency	200 cycles/minute
Service life	
• mechanical	10 x 10 ⁶ operating cycles
• electrical	3 x 10 ⁶ operating cycles at 230 V AC/50 mA/ cos φ = 1
Operating temperature	0 to +60 °C
Mounting position	Any
Air gaps and creepage distances	Basic standard IEC 60664-1; UL 508; Cul (Reference CSA C22.2 No. 142) overvoltage category III pollution degree 2
Dimensions (W x H x D) in mm	
6ES7924-0BE10-0B_0	Approx. 120 x 45 x 80

SIMATIC S7-300

Connection methods

Fully modular connection

4

Technical specifications function modules (continued)

Connection modules TPPro and TPPr

	Spring connection	Screw connection
Connectable cable cross-sections		
• Solid cables	No	
• flexible cables without wire end ferrule	0.5 to 2.5 mm ²	
• flexible cables with wire end ferrule in accordance with DIN 46228/1	0.5 to 1.5 mm ²	0.5 to 2.5 mm ² (2.5 mm ² with a crimp in accordance with EN 60947-1)
• flexible cables with wire end ferrule and plastic collar in accordance with DIN 46228/4	0.5 to 1.5 mm ²	
Number of wires per connection	1 or a combination of 2 conductors up to the cross-sections specified above (total) in a shared wire end ferrule	
Blade width of the screw-driver	3.5 mm (cylindrical shape)	
Tightening torque for connecting the cables	-	0.4 to 0.7 Nm

Ordering data front connectors Order No.

Front connector module (Compact CPU 312C)

Voltage infeed via

- Spring terminals
- Screw terminals

6ES7 921-3AJ20-0AA0

6ES7 921-3AK20-0AA0

Front connector module (Compact CPU 313C/314C-2PtP/314C-2DP), slot X1

Voltage infeed via

- Spring terminals
- Screw terminals

6ES7 921-3AL20-0AA0

6ES7 921-3AM20-0AA0

Front connector module (digital 2 x 8 I/O)

Voltage infeed via

- Spring terminals
- Screw terminals

6ES7 921-3AA00-0AA0

6ES7 921-3AB00-0AA0

Front connector module (digital 4 x 8 I/O)

Voltage infeed via

- Spring terminals
- Screw terminals

6ES7 921-3AA20-0AA0

A) 6ES7 921-3AB20-0AA0

Front connector module (1 x 8 outputs) for 2 ampere digital outputs

Voltage infeed via

- Spring terminals
- Screw terminals

6ES7 921-3AC00-0AA0

6ES7 921-3AD00-0AA0

Front connector module 20-pole (analog)

Voltage infeed via

- Spring terminals
- Screw terminals

6ES7 921-3AF00-0AA0

6ES7 921-3AG00-0AA0

Front connector module 40-pole (analog)

Voltage infeed via

- Spring terminals
- Screw terminals

6ES7 921-3AF20-0AA0

6ES7 921-3AG20-0AA0

A) Subject to export regulations: AL: N and ECCN: EAR99H

SIMATIC S7-300

Connection methods

Fully modular connection

Ordering data conn. cables

Pre-assembled round cable

16-pole, 0.14 mm²

unshielded

• 0.5 m	6ES7 923-0BA50-0CB0
• 1.0 m	6ES7 923-0BB00-0CB0
• 1.5 m	6ES7 923-0BB50-0CB0
• 2.0 m	6ES7 923-0BC00-0CB0
• 2.5 m	6ES7 923-0BC50-0CB0
• 3.0 m	6ES7 923-0BD00-0CB0
• 4.0 m	6ES7 923-0BE00-0CB0
• 5.0 m	6ES7 923-0BF00-0CB0

shielded

• 1.0 m	6ES7 923-0BB00-0DB0
• 2.0 m	6ES7 923-0BC00-0DB0
• 2.5 m	6ES7 923-0BC50-0DB0
• 3.0 m	6ES7 923-0BD00-0DB0
• 4.0 m	6ES7 923-0BE00-0DB0
• 5.0 m	6ES7 923-0BF00-0DB0

Round-sheath ribbon cable

16-pole, 0.14 mm²

unshielded

• 30 m	6ES7 923-0CD00-0AA0
• 60 m	6ES7 923-0CG00-0AA0

shielded

• 30 m	6ES7 923-0CD00-0BA0
• 60 m	6ES7 923-0CG00-0BA0

Round-sheath ribbon cable

2 x 16-pole, 0.14 mm²

unshielded

• 30 m	6ES7 923-2CD00-0AA0
• 60 m	6ES7 923-2CG00-0AA0

8 connectors (16-pole)

Insulation displacement system
with 8 cable grips

Accessories

Crimping tool

For processing the connectors
(female ribbon cable connector)

6ES7 928-0AA00-0AA0

Ordering data basic modules

Order No.

Connection module TP1

for 1-wire initiators

Packaging unit (1 unit)

• Spring terminals	6ES7 924-0AA10-0AB0
• Screw terminals	6ES7 924-0AA10-0AA0

Connection module TP3

for 3-wire initiators

Packaging unit (1 unit)

• Spring terminals	6ES7 924-0CA10-0AB0
• Screw terminals	6ES7 924-0CA10-0AA0

Connection module TPK

for 2 x 8 signals

Packaging unit (1 unit)

• Spring terminals	6ES7 924-1AA10-0AB0
• Screw terminals	6ES7 924-1AA10-0AA0

Connection module TP2

for 2 A modules

for 2-wire initiators

Packaging unit (1 unit)

• Spring terminals	6ES7 924-0BB10-0AB0
• Screw terminals	6ES7 924-0BB10-0AA0

Connection module TPA

for analog signals

Packaging unit (1 unit)

• Spring terminals	6ES7 924-0CC10-0AB0
• Screw terminals	6ES7 924-0CC10-0AA0

Accessories

Labeling plates

for connection modules

Insertable labeling plate
PU = 200 units

6ES7 928-2AB00-0AA0

Self-adhesive labeling plate
PU = 200 units

6ES7 928-2BB00-0AA0

Shield plate

for analog connection module
(4 units)

6ES7 928-1BA00-0AA0

Shield connection terminal

for shield plate, 2 units, with cable
diameter

• 2 to 6 mm (2 cables)	6ES7 390-5AB00-0AA0
• 3 to 8 mm	6ES7 390-5BA00-0AA0
• 4 to 13 mm	6ES7 390-5CA00-0AA0

A) Subject to export regulations: AL: N and ECCN: EAR99H

SIMATIC S7-300

Connection methods

Fully modular connection

4

Ordering data signal modules	Order No.	Ordering data function mod.	Order No.
Connection module TP1 with LED for 1-wire initiators Packaging unit (1 unit) <ul style="list-style-type: none"> • Spring terminals • Screw terminals 	6ES7 924-0AA10-0BB0 6ES7 924-0AA10-0BA0	Connection module TPRo for output signals for 2-wire connection Packaging unit (1 unit) <ul style="list-style-type: none"> • Spring terminals • Screw terminals 	6ES7 924-0BD10-0BB0 6ES7 924-0BD10-0BA0
Connection module TP3 with LED for 3-wire initiators Packaging unit (1 unit) <ul style="list-style-type: none"> • Spring terminals • Screw terminals 	6ES7 924-0CA10-0BB0 6ES7 924-0CA10-0BA0	Connection module TPRI for input signals for 2-wire connection Packaging unit (1 unit) <ul style="list-style-type: none"> • Spring terminals • Screw terminals 	6ES7 924-0BE10-0BB0 6ES7 924-0BE10-0BA0
Connection module TPK with LED for 2 x 8 signals Packaging unit (1 unit) <ul style="list-style-type: none"> • Spring terminals • Screw terminals 	6ES7 924-1AA10-0BB0 6ES7 924-1AA10-0BA0	Accessories Labeling plates for connection modules Insertable labeling plate PU = 200 units Self-adhesive labeling plate PU = 200 units Replacement relay for relay connection module PU = 4 units	6ES7 928-2AB00-0AA0 6ES7 928-2BB00-0AA0
Connection module TP2 with LED for 2 A modules for 2-wire initiators Packaging unit (1 unit) <ul style="list-style-type: none"> • Spring terminals • Screw terminals 	6ES7 924-0BB10-0BB0 6ES7 924-0BB10-0BA0	Replacement relay for TPRI Replacement relay for TPRo Optocoupler DC alternative for relay in the case of TPRo PU = 4 units	6ES7 928-3BA00-4AA0 6ES7 928-3AA00-4AA0 6ES7 928-3DA00-4AA0
Accessories Labeling plates for connection modules Insertable labeling plate PU = 200 units Self-adhesive labeling plate PU = 200 units	6ES7 928-2AB00-0AA0 6ES7 928-2BB00-0AA0	Optocoupler DC alternative for relay in the case of TPRo PU = 4 units	6ES7 928-3CA00-4AA0

SIMATIC S7-300

Connection methods

Flexible connection

www.DataSheet4U.com
Overview

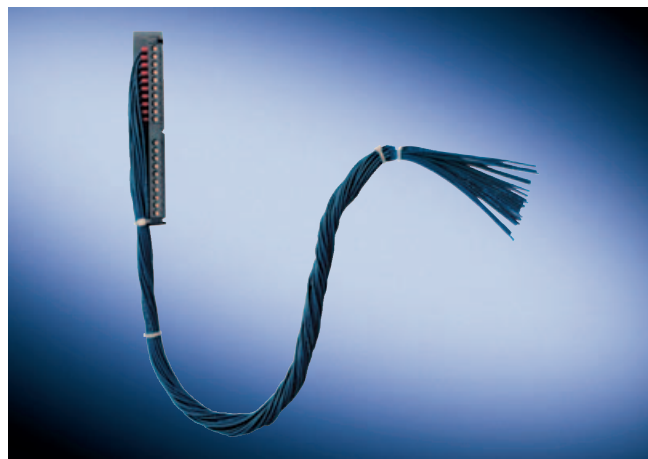

The flexible connection guarantees a fast and direct connection from the input/output modules of the SIMATIC S7-300/400 to the individual elements in the cabinet.

Already attached single cores reduce the wiring effort.

The core cross-sections of 0.5 mm² also allow higher currents.

Technical specifications

Front connector with single cores 16 channels

Rated operating voltage	24 V DC
Permissible continuous current with simultaneous load on all cores, max.	1.5 A
Permissible ambient temperature	0 to +60°C
Core type	H05V-K or with UL 1007/1569; CSA TR64
Number of single cores	20
Core cross-section	0.5 mm ² ; Cu
Bundle diameter in mm	Approx. 15
Color of core	Blue, RAL 5010
Designation of cores	Numbered from 1 to 20 (front connector contact = core number)
Fabrication	Screw or crimp contacts

Front connector with single cores 32 channels

Rated operating voltage	24 V DC
Permissible continuous current with simultaneous load of all wires, max.	1.5 A
Permissible ambient temperature	0 to +60°C
Core type	H05V-K or with UL 1007/1569; CSA TR64
Number of single cores	40
Core cross-section	0.5 mm ² ; Cu
Bundle diameter in mm	Approx. 17
Color of core	Blue, RAL 5010
Designation of cores:	Numbered from 1 to 40 (front connector contact = core number)
Fabrication	Screw or crimp contacts

SIMATIC S7-300

Connection methods

Flexible connection

Ordering data	Order No.	Ordering data	Order No.
Front connector with single cores for 16-channel digital modules SIMATIC S7-300, 20 x 0.5 mm²		Front connector with single cores for 32-channel digital modules SIMATIC S7-300, 40 x 0.5 mm²	
Core type H05V-K		Core type H05V-K	
<u>Screw version</u> Packaging unit (1 unit) Length: <ul style="list-style-type: none"> • 2.5 m 6ES7 922-3BC50-0AB0 • 3.2 m 6ES7 922-3BD20-0AB0 • 5 m 6ES7 922-3BF00-0AB0 • Special lengths on request 		<u>Screw version</u> Packaging unit (1 unit) Length: <ul style="list-style-type: none"> • 2.5 m 6ES7 922-3BC50-0AC0 • 3.2 m 6ES7 922-3BD20-0AC0 • 5.0 m 6ES7 922-3BF00-0AC0 • Special lengths on request 	
Packaging unit (5 units) Length: <ul style="list-style-type: none"> • 2.5 m 6ES7 922-3BC50-5AB0 • 3.2 m 6ES7 922-3BD20-5AB0 • 5.0 m 6ES7 922-3BF00-5AB0 		Packaging unit (5 units) Length: <ul style="list-style-type: none"> • 2.5 m 6ES7 922-3BC50-5AC0 • 3.2 m 6ES7 922-3BD20-5AC0 • 5.0 m 6ES7 922-3BF00-5AC0 	
<u>Crimp version</u> Packaging unit (1 unit) Length: <ul style="list-style-type: none"> • 2.5 m 6ES7 922-3BC50-0AF0 • 3.2 m 6ES7 922-3BD20-0AF0 • 5.0 m 6ES7 922-3BF00-0AF0 • Special lengths on request 		<u>Crimp version</u> Packaging unit (1 unit) Length: <ul style="list-style-type: none"> • 2.5 m 6ES7 922-3BC50-0AG0 • 3.2 m 6ES7 922-3BD20-0AG0 • 5.0 m 6ES7 922-3BF00-0AG0 • Special lengths on request 	
Core type UL/CSA-certified		Core type UL/CSA-certified	
<u>Screw-type version</u> Packaging unit (1 unit) Length: <ul style="list-style-type: none"> • 3.2 m 6ES7 922-3BD20-0UB0 • 5.0 m 6ES7 922-3BF00-0UB0 		<u>Screw version</u> Packaging unit (1 unit) Length: <ul style="list-style-type: none"> • 3.2 m 6ES7 922-3BD20-0UC0 • 5.0 m 6ES7 922-3BF00-0UC0 	

SIMATIC S7-300

Interface modules

IM 360/-361/-365 interface modules

www.DataSheet4U.com

Overview



- For connecting the racks in multitier SIMATIC S7-300 configurations
- IM 365: For configuring a central controller and up to one expansion rack
- IM 360/IM 361: For configuring a central controller and up to three expansion racks

Technical specifications

	6ES7 360-3AA01-0AA0	6ES7 361-3CA01-0AA0	6ES7 365-0BA01-0AA0
Supply voltages			
Rated value			
• DC 24 V		Yes	
Current consumption			
from backplane bus DC 5 V, max.	350 mA		100 mA
from supply voltage L+, max.		500 mA	
Power loss, typ.	2 W	5 W	0,5 W
Hardware config.			
Number of interfaces per CPU, max.	1	3	1; 1 pair
Dimensions and weight			
Width	40 mm	80 mm	40 mm
Height	125 mm	125 mm	125 mm
Depth	120 mm	120 mm	120 mm
Weights			
Weight, approx.	225 g	505 g	580 g

Ordering data

Ordering data	Order No.	Ordering data	Order No.
IM 360 interface module	6ES7 360-3AA01-0AA0	IM 365 interface module	6ES7 365-0BA01-0AA0
for expanding the S7-300 with max. 3 EUs; can be plugged into CC		for expanding the S7-300 with max. 1 EU; 2 modules with permanent connecting cable (1 m)	
IM 361 interface module	6ES7 361-3CA01-0AA0	SIMATIC Manual Collection ^{D)}	6ES7 998-8XC01-8YE0
for expanding the S7-300 with max. 3 EUs; can be plugged into EU		SIMATIC Manual Collection update service for 1 year ^{D)}	6ES7 998-8XC01-8YE2
Connecting cable		S7-300 manual	
between IM 360 and IM 361 or IM 361 and IM 361		Design, CPU data, module data, instruction list	
1 m	6ES7 368-3BB01-0AA0	German	6ES7 398-8FA10-8AA0
2.5 m	6ES7 368-3BC51-0AA0	English	6ES7 398-8FA10-8BA0
5 m	6ES7 368-3BF01-0AA0	French	6ES7 398-8FA10-8CA0
10 m	6ES7 368-3CB01-0AA0	Spanish	6ES7 398-8FA10-8DA0
		Italian	6ES7 398-8FA10-8EA0

D) Subject to export regulations: AL: N and ECCN: 5D992B1

SIMATIC S7-300 SIPLUS interface modules

SIPLUS IM 365 interface module

www.DataSheet4U.com
Overview



- SIPLUS IM 365: for configuring 1 central controller and no more than 1 expansion rack

4

Interface module	SIPLUS IM 365
Order No.	6AG1 365-0BA01-2AA0
Order No. based on	6ES7 365-0BA01-0AA0
Ambient temperature range	-25 °C to +60 °C, condensation permissible
Ambient conditions	Suitable for extraordinary medial load (for example by chloric and sulphuric atmospheres).
Technical data	The technical data are identical with the technical data of the based on modules.

Ordering data	Order No.
SIPLUS IM 365 interface module (extended temperature range and medial load) for expansion of S7-300 with max. 1 EU; 2 modules with fixed connection cable (1 m)	6AG1 365-0BA01-2AA0
Accessories	see IM 365, page 4/234

SIMATIC S7-300

Power supplies

Power supplies

www.DataSheet4U.com

Overview



- Load current supplies for S7-300/ET 200M
- To convert the line voltage to the required operating voltage (24V DC)
- Output current 2 A, 5 A or 10 A

Technical specifications

Power supply, type	2 A	2 A	5 A	5 A	10 A
Order No.	6ES7 307-1BA00-0AA0	6ES7 305-1BA80-0AA0	6ES7 307-1EA00-0AA0	6ES7 307-1EA80-0AA0	6ES7 307-1KA01-0AA0
Order No. SIPLUS		6AG1 305-1BA80-2AA0 ¹⁾		6AG1 307-1EA80-2AA0 ¹⁾	
Input	Single-phase AC	DC voltage	Single-phase AC	Single-phase AC	Single-phase AC
Rated voltage $V_{in \text{ rated}}$	120/230 V AC Set via switch on device	24 V ... 110 V DC Wide-range input	120/230 V AC Set via switch on device	120/230 V AC Set via switch on device	120/230 V AC Set via switch on device
Voltage range	85 ... 132 V AC/ 170 ... 264 V AC	16.8 ... 138 V DC	85 ... 132 V AC/ 170 ... 264 V AC	93 ... 132 V AC/ 187 ... 264 V AC	85 ... 132 V AC/ 170 ... 264 V AC
Overvoltage resistance	$2.3 \times V_{in \text{ rated}}$, 1.3 ms	154 V; 0.1 s	$2.3 \times V_{in \text{ rated}}$, 1.3 ms	$2.3 \times V_{in \text{ rated}}$, 1.3 ms	$2.3 \times V_{in \text{ rated}}$, 1.3 ms
Line buffering at $I_{out \text{ rated}}$	> 20 ms at $V_{in} = 93/187 \text{ V}$	> 10 ms at $V_{in \text{ rated}}$	> 20 ms at $V_{in} = 93/187 \text{ V}$	> 20 ms at $V_{in} = 93/187 \text{ V}$	> 20 ms at $V_{in} = 93/187 \text{ V}$
Rated line frequency; rated line-frequency range	50/60 Hz, 47 to 63 Hz	-	50/60 Hz; 47 Hz to 63 Hz	50/60 Hz, 47 Hz to 63 Hz	50/60 Hz, 47 Hz to 63 Hz
Rated current $I_{in \text{ rated}}$	0.9/0.6 A	2.7 ... 0.6 A (4 ... 0.9 A)	2.1/1.3 A	2.1/1.2 A	4.1/1.8 A
Switch-on current limit (+25 °C)	< 20 A, < 3 ms	< 20 A, < 10 ms	< 45 A, < 3 ms	< 45 A, < 3 ms	< 55 A, < 3 ms
I^2t	< 1.0 A ² s	< 5 A ² s	< 1.2 A ² s	< 1.8 A ² s (typ. 1.2 A ² s)	< 3.3 A ² s
Built-in line-side fuse	T 1.6 A/250 V (inaccessible)	T 6.3 A/250 V (inaccessible)	F 4 A/250 V (inaccessible)	T 3.15 A/250 V (inaccessible)	T 6.3 A/250 V (inaccessible)
Recommended miniature circuit-breaker (IEC 898) in the supply line	3 A, Characteristic C	At and above 10 A, C characteristic, suitable for DC	At and above 6 A, C characteristic	at and above 10 A, Characteristic C or at and above 6 A, Characteristic D	At and above 10 A, C characteristic
Output	Controlled, isolated DC voltage	Controlled, isolated DC voltage	Controlled, isolated DC voltage	Controlled, isolated DC voltage	Controlled, isolated DC voltage
Rated voltage $V_{out \text{ rated}}$	24 V DC	24 V DC	24 V DC	24 V DC	24 V DC
Total tolerance	± 3 %	± 3 %	± 3 %	± 3 %	± 3 %
• Static line smoothing	approx. 0.1 %	approx. 0.2 %	approx. 0.1 %	approx. ± 0.2 %	approx. 0.1%
• Static load smoothing	approx. 0.2 %	approx. 0.4 %	approx. 0.2 %	approx. ± 0.4 %	approx. 0.5%
Ripple content (clock frequency: approx. 50 kHz; approx. 70 kHz with 6ES7 307-1BA00-0AA0)	< 150 mV _{pp} (typ. < 20 mV _{pp})	< 150 mV _{pp} (typ. < 30 mV _{pp})	< 150 mV _{pp} (typ. 40 mV _{pp})	< 150 mV _{pp} (typ. 40 mV _{pp})	< 150 mV _{pp} (typ. 40 mV _{pp})
Spikes (bandwidth: 20 MHz)	< 240 mV _{pp} (typ. < 150 mV _{pp})	< 240 mV _{pp} (typ. < 150 mV _{pp})	< 240 mV _{pp} (typ. 90 mV _{pp})	< 240 mV _{pp} (typ. 90 mV _{pp})	< 240 mV _{pp} (typ. 100 mV _{pp})
Adjustment range	-	-	-	-	-

1) SIPLUS module for temperature range -25 ... +60°C and use under medial load (e.g. sulphur chloride atmosphere).

This SIPLUS power supply conforms with standards for electronic equipment used on rolling stock (EN 50155, temperature T1, category 1).

www.DataSheet4U.com
Technical specifications (continued)

Order No.	6ES7 307-1BA00-0AA0	6ES7 305-1BA80-0AA0	6ES7 307-1EA00-0AA0	6ES7 307-1EA80-0AA0	6ES7 307-1KA01-0AA0
Order No. SIPLUS		6AG1 305-1BA80-2AA0 ¹⁾		6AG1 307-1EA80-2AA0 ¹⁾	
Status indicator	Green LED for 24 V OK	Green LED for 24 V OK	Green LED for 24 V OK	Green LED for 24 V OK	Green LED for 24 V OK
Response on activation/deactivation	No overshoot of V_{out} (soft start)	No overshoot of V_{out} (soft start)	No overshoot of V_{out} (soft start)	No overshoot of V_{out} (soft start)	No overshoot of V_{out} (soft start)
Startup delay/voltage rise	< 3 s/typ.60 ms	< 3 s (typ.7 ms)/typ. 5 ms	< 2 s (typ.60 ms)	< 3 s/typ.100 ms	< 1.5 s/typ.80 ms
Rated current $I_{out rated}$	2 A	2 A (3 A with $V_{in} > 24 V$)	5 A	5 A	10 A
Current range					
• Up ... +45 °C	0 A ... 2 A	0 ... 2 A (3 A)	0 A ... 5 A	0 A ... 5 A	0 A ... 10 A
• Up ... +60 °C	0 A ... 2 A	0 ... 3 A (3 A)	0 A ... 5 A	0 A ... 5 A	0 A ... 10 A
Dynamic V/I at					
• Power-up on short-circuit	typ. 10 A for 90 ms	typ. 9 A for 270 ms	typ. 20 A for 75 ms	typ. 20 A for 180 ms	typ. 35 A for 80 ms
• Short-circuit during operation	typ. 10 A for 90 ms	typ. 9 A for 270 ms	typ. 20 A for 75 ms	typ. 20 A for 80 ms	typ. 35 A for 150 ms
Parallel switching for enhanced performance	not permissible	Yes, 2 units	not permissible	not permissible	not permissible
Efficiency					
Efficiency at $V_{out rated}$, $I_{out rated}$	approx. 83 %	approx. 75 %	approx. 87 %	approx. 84 %	approx. 87 %
Power loss at $V_{out rated}$, $I_{out rated}$	approx. 10 W	approx. 16 W (24 W)	approx. 18 W	approx. 23 W	approx. 34 W
Closed-loop control					
Dynamic line smoothing ($V_{in rated} \pm 15\%$)	$\pm 0.3\% V_{out}$	$\pm 0.3\% V_{out}$	$\pm 0.3\% V_{out}$	$\pm 0.3\% V_{out}$	$\pm 0.3\% V_{out}$
Dynamic load smoothing (I_{out} : 50/100/50 %)	$\pm 0.8\% V_{out}$	$\pm 2.5\% V_{out}$	$\pm 2.5\% V_{out}$	$\pm 3\% V_{out}$	$\pm 2.5\% V_{out}$
Load-step settling time					
• 50 at 100 %	< 5 ms (typ. 2.5 ms)	< 5 ms (typ. 2.5 ms)	typ. 0.1 ms	< 5 ms (typ. 0.2 ms)	< 5 ms
• 100 at 50%	< 5 ms (typ. 2.5 ms)	< 5 ms (typ. 2.5 ms)	Typ. 0.1 ms	< 5 ms (typ. 0.2 ms)	< 5 ms
Protection and monitoring					
Output overvoltage protection	Additional control loop, shutdown at approx. 30 V, automatic restart	Additional control loop, shutdown at approx. 30 V, automatic restart	Additional control loop, shutdown at approx. 30 V, automatic restart	Additional control loop, shutdown at approx. 30 V, automatic restart	Additional control loop, shutdown at approx. 30 V, automatic restart
Current limit	2.2 A ... 2.6 A	3.3 A ... 3.9 A	5.5 A ... 6.5 A	5.5 A ... 6.5 A	11 A ... 12 A
Short-circuit protection	Electronic shutdown, automatic restart	Electronic shutdown, automatic restart	Electronic shutdown, automatic restart	Electronic shutdown, automatic restart	Electronic shutdown, automatic restart
Sustained-short-circuit-current rms value	< 4 A	< 2 A	< 9 A	< 5 A	< 10 A
Overload/short-circuit indicator	-	-	-	-	-
Safety					
Primary/secondary galvanic isolation	Yes, safety extra-low output voltage V_{out} to EN 60950 and EN 50178	Yes, safety extra-low output voltage V_{out} to EN 60950 and EN 50178, creepages and clearances > 5 mm	Yes, safety extra-low output voltage V_{out} to EN 60950 and EN 50178	Yes, safety extra-low output voltage V_{out} to EN 60950 and EN 50178, creepages and clearances > 8 mm	Yes, safety extra-low output voltage V_{out} to EN 60950 and EN 50178
Protection class	Class I	Class I	Class I	Class I	Class I
Leakage current	< 3.5 mA (typ. 0.7 mA)	< 3.5 mA (typ. 0.7 mA)	< 3.5 mA (typ. 0.3 mA)	< 3.5 mA (typ. 0.3 mA)	< 3.5 mA (typ. 0.5 mA)

1) SIPLUS module for temperature range -25 ... +60°C and use under medial load (e.g. sulphur chloride atmosphere).

This SIPLUS power supply conforms with standards for electronic equipment used on rolling stock (EN 50155, temperature T1, category 1).

SIMATIC S7-300

Power supplies

Power supplies

Technical specifications (continued)

Order No.	6ES7 307-1BA00-0AA0	6ES7 305-1BA80-0AA0	6ES7 307-1EA00-0AA0	6ES7 307-1EA80-0AA0	6ES7 307-1KA01-0AA0
Order No. SIPLUS		6AG1 305-1BA80-2AA0 ¹⁾		6AG1 307-1EA80-2AA0 ¹⁾	
German Technical Inspectorate approval	Yes	Yes	Yes	Yes	Yes
CE label	Yes	Yes	Yes	Yes	Yes
UL/cUL (CSA) approval	Yes, UL-listed (UL 508) File E143289, CSA (CSA22.2 No. 14-95)	Yes, UL-listed (UL 508), file E143289, CSA (CSA22.2 no. 14-95)	Yes, UL-listed (UL 508), file E143289, CSA (CSA 22.2 no. 14-95)	Yes, UL-Listed (UL 508) File E143289, CSA (CSA22.2 No. 14-95)	Yes, UL-listed (UL 508), file E143289, CSA (CSA22.2 no. 14-95)
FM approval	Yes, Class I Div. 2 Group A, B, C, D T4	-	Yes, Class I Div. 2 Group A, B, C, D, T 4	-	Yes, Class I Div. 2, A, B, C, D, T4
Marine type approval	in S7-300 system	Yes, GL, LRS	in S7-300 system	Yes, GL, LRS	in S7-300 system
Degree of protection (EN 60529)	IP20	IP20	IP20	IP20	IP20
EMC					
Emitted interference	EN 55022 Class B	EN 55011 Class A	EN 55022 Class B	EN 55011 Class A	EN 55022 Class B
Supply-harmonics limitation	Not applicable	Not applicable	EN 61000-3-2	-	EN 61000-3-2
Noise immunity	EN 61000-6-2	EN 61000-6-2	EN 61000-6-2	EN 61000-6-2	EN 61000-6-2
Operating data					
Ambient temperature range	0°C ... +60°C with natural convection	-25°C ... +70°C with natural convection	0°C ... +60°C with natural convection	-25°C ... +70°C with natural convection	0°C ... +60°C with natural convection
Transport/storage temperature range	-40 °C ... +85 °C	- 40 ... + 85 °C	-40 °C ... +85 °C	- 40 ... + 85 °C	- 40 ... + 85 °C
Humidity class	Climate class 3K3 to EN 60721, no condensation	Climate class 3K5 to EN 60721, transient condensation permitted	Climate class 3K3 to EN 60721, no condensation	Climate class 3K5 to EN 60721, transient condensation permitted	Climate class 3K3 to EN 60721, no condensation
Mechanical system					
Ports					
• Supply input L, N, PE (DC input: L+1, M1, PE)	Solid/finely-stranded per screw-type terminal for 0.5 mm to 2.5 mm ²	Solid/finely-stranded per screw-type terminal for 0.5 mm to 2.5 mm ²	Solid/finely-stranded per screw-type terminal for 0.5 mm to 2.5 mm ²	Solid/finely-stranded per screw-type terminal for 0.5 mm to 2.5 mm ²	Solid/finely-stranded per screw-type terminal for 0.5 mm to 2.5 mm ²
• Output L+	2 screw-type terminals for 0.5 mm to 2.5 mm ²	3 screw-type terminals for 0.5 mm to 2.5 mm ²	3 screw-type terminals for 0.5 mm to 2.5 mm ²	3 screw-type terminals for 0.5 mm to 2.5 mm ²	4 screw-type terminals for 0.5 mm to 2.5 mm ²
• Output M	2 screw-type terminals for 0.5 mm to 2.5 mm ²	3 screw-type terminals for 0.5 mm to 2.5 mm ²	3 screw-type terminals for 0.5 mm to 2.5 mm ²	3 screw-type terminals for 0.5 mm to 2.5 mm ²	4 screw-type terminals for 0.5 mm to 2.5 mm ²
Dimensions (W x H x D) in mm	50 x 125 x 120	80 x 125 x 120	80 x 125 x 120	80 x 125 x 120	120 x 125 x 120
Weight, approx.	0.42 kg	0.75 kg	0.74 kg	0.57 kg	1.1 kg
Assembly	Snaps onto S7 busbar	Snaps onto S7 busbar	Snaps onto S7 busbar	Snaps onto S7 busbar	Snaps onto S7 busbar
Accessories	Mounting adapter for DIN rail and PS-CPU power connector	Mounting adapter for DIN rail and PS-CPU power connector	Mounting adapter for DIN rail and power connector	Mounting adapter for DIN rail and power connector	Mounting adapter for DIN rail and PS-CPU power connector

1) SIPLUS module for temperature range -25 ... +60°C and use under medial load (e.g. sulphur chloride atmosphere).

This SIPLUS power supply conforms with standards for electronic equipment used on rolling stock (EN 50155, temperature T1, category 1).

SIMATIC S7-300

Power supplies, accessories

Power supplies

4

www.DataSheet4U.com

Ordering data	Order No.	Ordering data	Order No.
PS 305/307 load power supply incl. power connector 120/230 V AC / 24 V DC; 2 A 24 ... 110 V DC / 24 V DC; 2 A, for extended temperature range 120/230 V AC / 24 V DC; 5 A 120/230 V AC / 24 V DC; 5 A, for extended temperature range 120/230 V AC / 24 V DC; 10 A	6ES7 307-1BA00-0AA0	SIPLUS load power supply PS 305/307 for temperature range -25 ... +60°C and use under medial load (e.g. sulphur chloride atmosphere). Conforms with standard for electronic equipment used on rolling stock (EN 50155, temperature T1, category 1). 24 ... 110 V DC / 24 V DC; 2 A 120/230 V AC / 24 V DC; 5 A Installation adapter For snapping the PS 307 onto a 35 mm DIN rail (EN 50022) PS-CPU power connector Spare part	
	6ES7 305-1BA80-0AA0		
	6ES7 307-1EA00-0AA0		6AG1 305-1BA80-2AA0
	6ES7 307-1EA80-0AA0		6AG1 307-1EA80-2AA0
	6ES7 307-1KA01-0AA0		6ES7 390-6BA00-0AA0
			6ES7 390-7BA00-0AA0

DIN Rail

Overview

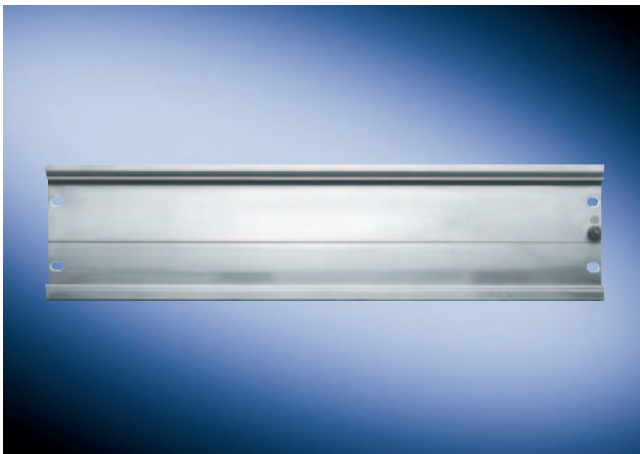

- The mechanical mounting rack of the SIMATIC S7-300
- For accommodating the modules
- Can be screwed onto the wall

Ordering data

Ordering data	Order No.
DIN rail	
160 mm	6ES7 390-1AB60-0AA0
482 mm	6ES7 390-1AE80-0AA0
530 mm	6ES7 390-1AF30-0AA0
830 mm	6ES7 390-1AJ30-0AA0
2000 mm	6ES7 390-1BC00-0AA0

SIMATIC S7-300

Accessories

Labeling sheets

www.DataSheet4U.com

Overview

Labeling sheets

- Film sheets for application-specific labeling of SIMATIC S7-300 I/O modules with commercial laser printers
- Single-color films, tear-resistant, dirt-resistant
- Easy handling:
 - Pre-perforated labeling sheets in DIN A4 format to allow easy separation of the labeling strips
 - The separated strips can be inserted directly into the I/O modules
- Different colors for distinction between module types or preferred areas of application:
The labeling sheets are available in the colors teal, light beige, red and yellow. Yellow is reserved for failsafe systems.

Labeling strips.

- Teal-colored writable plastic strips
- For insertion in the front connector
- Spare part, 10 items

Label cover

- Teal-colored film
- To cover and hold user-made labeling strips on normal paper
- Accessories, 10 items

Technical specifications

	Labeling sheets for S7-300
Dimensions	DIN A4
Labeling strips per sheet, pre-perforated	10
Weight, approx.	0.1 kg

Ordering data

Order No.

Labeling sheets

for 16-channel signal modules, DIN A4, for printing with laser printer; 10 pieces

petrol

6ES7 392-2AX00-0AA0

light-beige

6ES7 392-2BX00-0AA0

yellow

6ES7 392-2CX00-0AA0

red

6ES7 392-2DX00-0AA0

for 32-channel signal modules, DIN A4, for printing with laser printer; 10 pieces

petrol

6ES7 392-2AX10-0AA0

light-beige

6ES7 392-2BX10-0AA0

yellow

6ES7 392-2CX10-0AA0

red

6ES7 392-2DX10-0AA0

Labeling strips

10 pieces (spare part)

for modules with 20-pin front connector

6ES7 392-2XX00-0AA0

for modules with 40-pin front connector

6ES7 392-2XX10-0AA0

Label cover

10 pieces (spare part)

for modules with 20-pin front connector

6ES7 392-2XY00-0AA0

for modules with 40-pin front connector

6ES7 392-2XY10-0AA0

