

LIYAN PROGRAMMABLE LOGIC CONTROLLER

LYPLC
Ex1n2PT

USER'S MANUAL

Foreword

◆ This manual contains text, diagrams and explanations which will guide the reader in the correct installation and operation of the Ex1n2PT Platinum temperature sensor input block. It should be read and understood before attempting to install or use the unit. If in doubt about the operation or use of Ex1n2PT Platinum temperature sensor input block please consult Liyan Electric.

Introduction

The Ex1n2PT Platinum temperature sensor input block (hereafter referred to as “Ex1n2PT”) converts 2 points of analog input values (temperature input) into digital values, and transfers them to the PLC main unit.

The Ex1n2PT can be connected to Ex1n, Ex2n Series PLC.

- 1) Analog inputs can be set to Celsius or Fahrenheit mode and read measured analog data through FROM/TO instructions of PLC main unit.
- 2) The resolution is 0.1 °C when the PT100 input is used.

External Dimensions

Dimension: mm

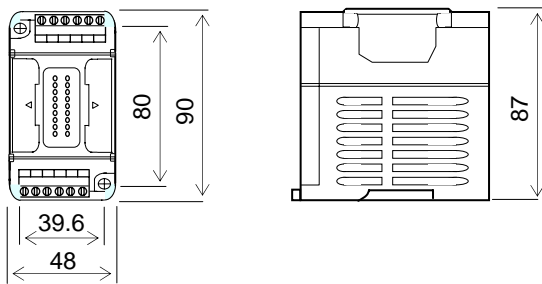

Terminal Signal: This module don't occupy any I/O points and never perform wiring to terminals.

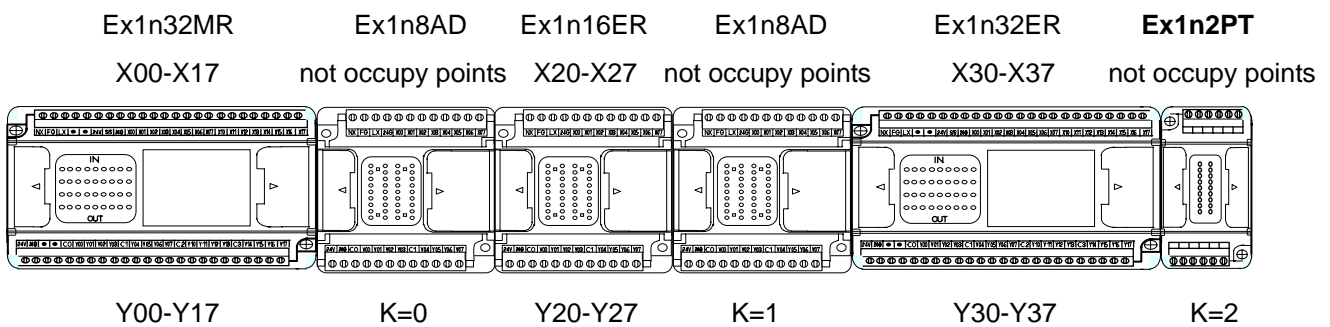

Status indicator LED

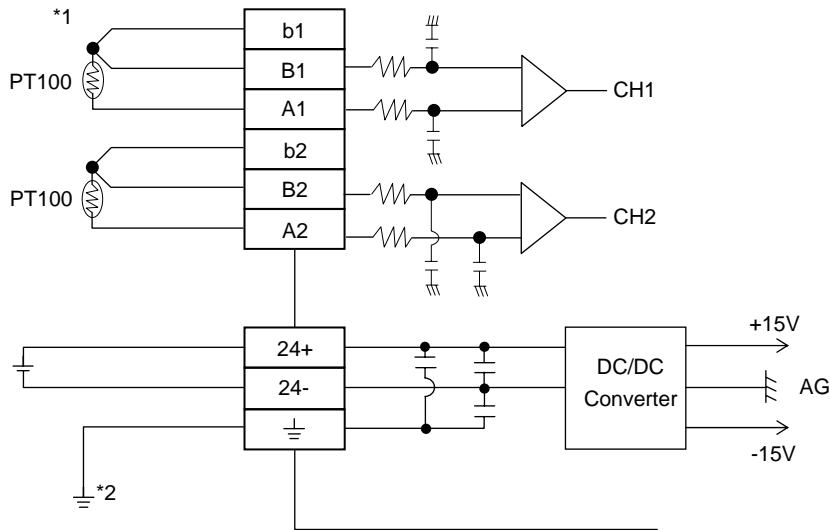

Indication	Description
PWR	External 24V power indicator

Ex1n2PT Wiring



Remark

*1 The analog input line, should separate it from other power lines or a lines easily induced.

*2 Make sure to connect the  terminal to the  terminal of the PLC main unit.

Specifications

General specifications

Item	Specifications
Ambient temperature range	0 to +55 °C during operation, storage temperature: -20~70°C
Ambient humidity	35 to 85 % RH during operation (Dew condensation shall not be allowed.)
Noise resistance	Noise voltage 1,000 Vp-p, noise width 1 μs.
Withstand voltage	500 V AC for 1 min (between analog input terminal and each terminal of PLC main unit)
Insulation resistance	DC500V / 5 MΩ
Operating atmosphere	Corrosive gas and many dusts shall not be detected.

Power supply specifications

Item	Specifications
Interface driving power supply	24 V DC±10%, 100 mA, supplied via terminal from outside
CPU driving power supply	5 V DC, 40mA, supplied via extension cable from PLC main unit

Performance specifications

Item	Specifications
Conversion speed	When only voltage input and current input are used 500 μs x Number of used channels
Insulation method	Photo-coupler insulates analog input area from PLC. DC/DC converter insulates power supply from analog I/O.
occupied I/O points	Don't occupy any I/O points
Applicable PLC	Ex1n, Ex2n Series PLC

Buffer Memories (BFM) lists

BFM No.	Description	Initial value
#0	Input mode selection of CH1 to CH2.	H0099
#1	Reserved	—
#2	Number of times of averaging of CH1 Setting range :1 to 8 times	8
#3	Number of times of averaging of CH2 Setting range :1 to 8 times	8
#4	Reserved	—
#5	Reserved	—
#6	Reserved	—
#7	Reserved	—
#8	Reserved	—
#9	Reserved	—
#10	CH1 data (immediate data or average data)	0
#11	CH2 data (immediate data or average data)	0
#12	Reserved	—
#13	Reserved	—
#14	Reserved	—
#15	Reserved	—
#16	Reserved	—
#17	Reserved	—
#18	CH1 to CH2 start conversion enable bit selection	H0000
...	Reserved	—
#22	Sets convenient functions (data addition, upper/lower limit value detection, sudden change detection and peak value hold.)	K1
#23	Reserved	—
...	Reserved	—
#29	Error status	K0
#30	Model code & Serial No. of Version	
#31	Reserved	—
#32	Operating time 0 to 64,800 (s). After that, 64,800 is kept. Measurement starts when power is turned on, and measured value is reset when power is turned off.	K0
#33	Reserved	—
...	Reserved	—
#37	Reserved	—
#38	Reserved	—
...	Reserved	—
#41-48	Reserved	—
#51-58	Reserved	—

...	Reserved	
#60	When value = 2561, force module to restart (V1.28 or more is effective)	–
#61	CH1 addition data Setting range: -2,000 to +2,000 (valid while BFM #22 b0 is ON)	K0
#62	CH2 addition data Setting range: -2,000 to +2,000 (valid while BFM #22 b0 is ON)	K0
#63	Reserved	–
#64	Reserved	–
#65	Reserved	–
#66	Reserved	–
#67	Reserved	–
#68	Reserved	–
...	Reserved	–
#71	CH1 lower limit value error set value (valid while BFM #22 b1 is ON)	Minimum digital value inside input range
#72	CH2 lower limit value error set value (valid while BFM #22 b1 is ON)	Minimum digital value inside input range
#73	Reserved	–
#74	Reserved	–
#75	Reserved	–
#76	Reserved	–
#77	Reserved	–
#78	Reserved	–
...	Reserved	–
#81	CH1 upper limit value error set value (valid while BFM #22 b1 is ON)	Maximum digital value inside input range
#82	CH2 upper limit value error set value (valid while BFM #22 b1 is ON)	Maximum digital value inside input range
#83	Reserved	–
#84	Reserved	–
#85	Reserved	–
#86	Reserved	–
#87	Reserved	–
#88	Reserved	–
...	Reserved	–

#101	CH1 peak value (minimum value) (valid while BFM #22 b3 is ON)	
#102	CH2 peak value (minimum value) (valid while BFM #22 b3 is ON)	
#103	Reserved	
#104	Reserved	
#105	Reserved	
#106	Reserved	
#107	Reserved	
#108	Reserved	
#109	Peak value (minimum value) reset flag	K0
#110	Unusable	
#111	CH1 peak value (maximum value) (valid while BFM #22 b3 is ON)	
#112	CH2 peak value (maximum value) (valid while BFM #22 b3 is ON)	
#113	Reserved	
#114	Reserved	
#115	Reserved	
#116	Reserved	
#117	Reserved	
#118	Reserved	
#119	Peak value (maximum value) reset flag	K0
...	Reserved	-
#148	Count scan times(Circular counter 0-65536)	
...	Reserved	-
#180	Reserved	
#181	Reserved	
#182	Reserved	
#182	PT100 Platinum resistance, temperature coefficient α	
...	Reserved	
#192-199	CH1 data history	
#200-207	CH2 data history	
#208-215	Reserved	
#216-223	Reserved	
#224-231	Reserved	
#232-239	Reserved	
#240-247	Reserved	
#248-255	Reserved	

Details of buffer memories

1 BFM #0, #1: Input mode selection

The input mode by writing a numeric value to BFM #0 and BFM#1 to assign CH1 to CH2 operation mode to BFM#0. In the input mode specification, each BFM is expressed in a 4-digit hexadecimal code, and each channel No. is assigned to each digit.

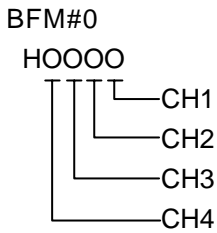

O=9: Platinum resistance input mode, PT100, Celsius display (-100 to +600°C), resolution 0.1°C

O=C: Platinum resistance input mode, PT100, Fahrenheit display (-148 to +1,112°F), resolution 0.1°F

2 BFM #2 to BFM #3: Number of times of averaging

When using BFM #10 to #11 as the average data, write the number of times of averaging to BFM #2 to BFM #3. The setting range of the number of times of averaging is 1 to 8. If select the immediate data, value of BFM#2 to BFM#3 is 1.

3 BFM #10 to BFM #11: Analog data

The A/D conversion data of each channel is written to BFM #10 to BFM #11.

You can select the immediate (current value) data or the average data by setting the number of times of averaging (BFM #2 to BFM #3).

4 BFM #18: Bxxxxxxxxnnnnnnnn

Bit No.	b15 to b18	b7	b6	b5	b4	b3	b2	b1	b0
n=0	Reserved	Reserved	Reserved	Reserved	Reserved	Reserved	Reserved	CH2 disable	CH1 disable
n=1	Reserved	Reserved	Reserved	Reserved	Reserved	Reserved	Reserved	CH2 enable	CH1 enable

5 BFM #22: Sets convenient functions

The functions described below are assigned to b0 to b1 of BFM #22. When a bit is set to ON, the assigned function becomes valid.

b0 : Data addition function

When this bit set to ON, the measured value will add addition value and stored into BFM#10~BFM#11.

b1 : Upper / lower limit value detection function

Reserved

b2 : Reserved

b3 : When this bit set to ON, peak value will be stored into BFM#101~BFM#102, BFM#111~BFM#112.

6 BFM#30: Model code

Fixed value : "K4xxx" ◦ Xxx is version code

7 BFM#31: Reserved be sure not to use it

Standard I/O Characteristics

9. Platinum resistance input, PT100, Celsius

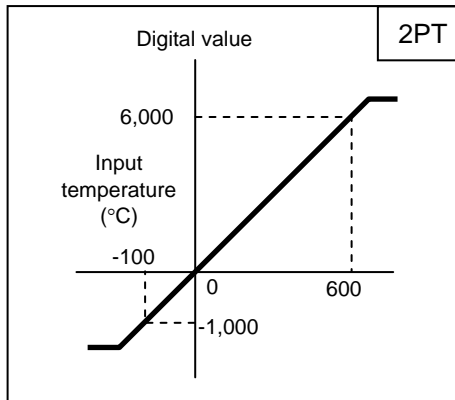

C. Platinum resistance, PT100, Fahrenheit

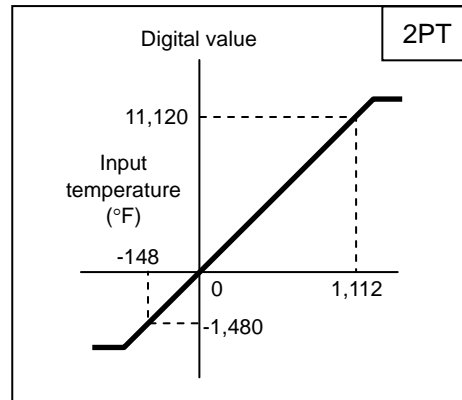

FROM/TO Instruction

FROM Instruction

FNC(78)			16 bits: FROM(P) ----- 9 steps	EX	EX _{1S}	EX _{1N}	EX _{2N}
D	FROM	P	32 bits: (D)FROM(P) -----17 steps				

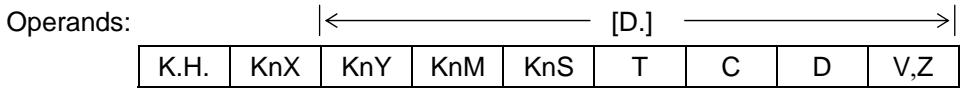

Operands: |← →| m1 = 0 ~ 7 no. of special module
 m2.= 0 ~ 32767 no. of buffer memory (BFM)
 n.= 1 ~ 31 no. of read (when D, n=1~15)

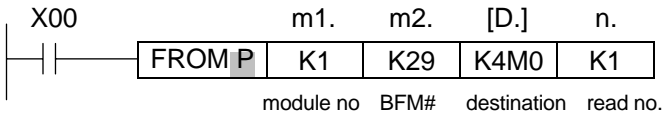

◆ When X00 ON, the buffer memory of special module BFM#29 to be read out and stored into M00~M15.

<< Special Device Module Number m1 >>

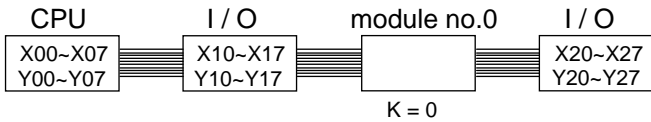

- ◆ The BFM is the memory address of special module.
- ◆ The number of special module is address to NO.0~NO.7 and beginning with the one closest to the CPU unit.
- ◆ The special module can up to 8 maximum, and no occupy i/o points.

TO

FNC(79)			16 bits: TO(P) ----- 9 steps	EX	EX _{1S}	EX _{1N}	EX _{2N}
D	TO	P	32 bits: (D)TO(P) ----- 17 steps				

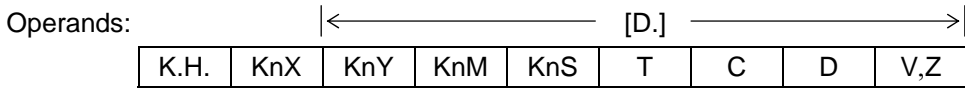

Operands: |← →| m1 = 0 ~ 7 no. of special module
 m2.= 0 ~ 32767 no. of buffer memory (BFM)
 n.= 1 ~ 31 no. of write (when D, n=1~15)

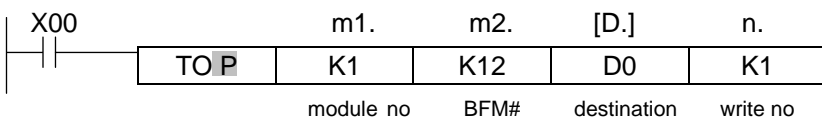

- ◆ When X00 ON, the content of D0 to be write into the buffer memory BFM#12 of the special module NO.1
- ◆ If used pulse command can decrement cycle time.

<< Number of Read n >>

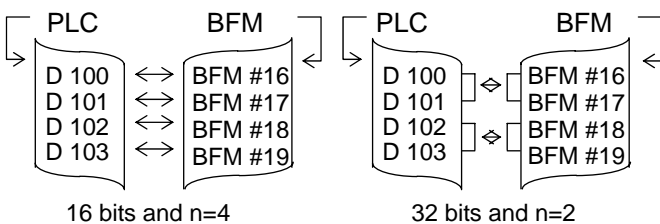

Configuration of Hardware

EXPLC main unit Ex1n2PT Ex1n2PT

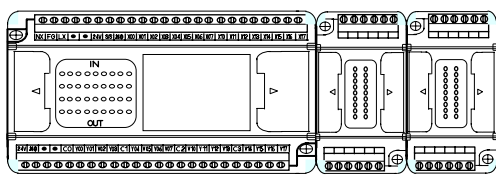

Example program

```

M8002
|-----|/|-----[TO K0 K0 H0099 K1 ] select 1st 2PT CH1-CH2 are Celsius display
|-----|/|-----[TO K1 K0 H00CC K1 ] select 2nd 2PT CH1-CH2 are Fahrenheit display
M8002
|-----|/|-----[TO K0 K18 H0003 K1 ] enable 1st 2PT CH1-CH2
|-----|/|-----[TO K1 K18 H0003 K1 ] enable 2nd 2PT CH1-CH2
M8002
|-----|/|-----[FROM K0 K30 D830 K1 ] read 1st version code
|-----|/|-----[FROM K1 K30 D930 K1 ] read 2nd version code
M8002
|-----|/|-----[TO K0 K183 K395 K1 ] change 1st PT100 temperature coefficient is 0.395Ω/1°C
|-----|/|-----[TO K1 K183 K395 K1 ] change 2nd PT100 temperature coefficient is 0.395Ω/1°F
M8003
|-----|/|-----[FROM K0 K10 D810 K2 ] read 1st 2PT current measuring value
|-----|/|-----[FROM K1 K10 D910 K2 ] read 2nd 2PT current measuring value
|-----|/|-----[ END ]

```

LIYAN PROGRAMMABLE LOGIC CONTROLLER

Ex1n2PT-edoc0511v128a

LIYAN ELECTRIC INDUSTRIAL LTD.

TEL : 886 - 4 - 25613700

FAX : 886 - 4 - 25613408

Website : <http://www.liyanplc.com>

E - mail : twliyan@ms16.hinet.net